

Interactive System Productivity Facility (ISPF)



User's Guide Volume II

z/OS Version 2 Release 10

Note

Before using this information and the product it supports, read the information in "Notices" on page 545.

First Edition (September 2013)

This edition applies to ISPF for Version 2 Release 1.0 of the licensed program z/OS (program number 5650-ZOS) and to all subsequent releases and modifications until otherwise indicated in new editions.

IBM welcomes your comments. For information on how to send comments, see "How to send your comments to IBM" on page xxi.

The ISPF development team maintains a site on the World Wide Web. The URL for the site is: <http://www.ibm.com/software/awdtools/ispf/>

© **Copyright IBM Corporation 1980, 2013.**

US Government Users Restricted Rights – Use, duplication or disclosure restricted by GSA ADP Schedule Contract with IBM Corp.

Contents

Figures	vii
--------------------------	------------

Tables	xi
-------------------------	-----------

Preface	xiii
--------------------------	-------------

About this document	xiii
Who should use this document	xiii
What is in this document	xiii
How to read the syntax diagrams.	xiv

z/OS information	xix
-----------------------------------	------------

How to send your comments to IBM	xxi
---	------------

If you have a technical problem	xxi
---	-----

Summary of changes.	xxiii
--------------------------------------	--------------

Product function changes made in z/OS V2R1.0	
ISPF	xxiii
ISPF product changes	xxiii
ISPF Dialog Manager component changes	xxiii
ISPF PDF component changes	xxiv
ISPF SCLM component changes	xxiv
Migration considerations	xxiv
Changes to this document for z/OS V2R1.0 ISPF	xxv

What's in the z/OS V2R1.0 ISPF library?	xxvii
--	--------------

Chapter 1. Primary Option Menu (POM)	1
---	----------

The Primary Option Menu panel	1
ISPF primary options	1
Primary Option Menu action bar choices	3
Status area on the Primary Option Menu	5
Status pull-down	6
Defining the status area	13

Chapter 2. Settings (option 0)	23
---	-----------

ISPF Settings panel fields	24
Select options.	24
Terminal characteristics	27
Print graphics parms	28
General.	30
ISPF Settings panel action bar	30
Specifying log and list defaults and characteristics (the Log/List action bar choice).	32
Working with function keys and keylists (the Function Keys action bar choice)	37
The Function keys pull-down	50
Changing default colors (the Colors action bar choice)	51
Specifying ISPF ENVIRON settings (the Environ action bar choice)	57

Specifying shared profile settings (the Environ action bar choice)	58
Specifying workstation parameters (the Workstation action bar choice)	59
Displaying message, system, user, panel, and screen IDs	72

Chapter 3. View (option 1)	77
---	-----------

View Entry Panel action bar	78
View Entry Panel fields	79
Browsing a data set.	80
Ending browse	81
Browse primary commands	81

Chapter 4. Edit (option 2)	95
---	-----------

Editing a data set	95
Edit Entry Panel action bar	96
Edit Entry Panel fields.	96
Distributed editing	99
Double-byte character set support	100

Chapter 5. Utilities (option 3)	101
--	------------

Utility Selection Panel action bar	101
Library utility (option 3.1)	101
Library Utility panel action bar	102
Library Utility panel fields	102
Library utility options for data sets	102
Library utility options for members	111
Data set utility (option 3.2)	113
Data Set Utility panel action bar	113
Data Set Utility panel fields	114
Data set utility options	114
Move/Copy utility (option 3.3)	133
Move/Copy Utility panel action bar.	133
Move/Copy Utility panel fields	134
Move/Copy utility options.	134
Data set list utility (option 3.4)	140
Data Set List Utility panel action bar	141
Data Set List Utility panel fields	142
Data set list utility options	148
Data set list utility line commands	162
Data set list utility primary commands	171
Reset ISPF statistics utility (option 3.5)	180
Reset ISPF statistics panel action bar	180
Reset ISPF statistics panel fields	181
Reset ISPF statistics utility options	182
Hardcopy utility (option 3.6)	184
Hardcopy utility panel action bar.	184
Hardcopy utility panel fields	185
Generating and submitting JCL	185
Additional batch printing information	187
Using the TSO/E information center facility	187
Download data set to workstation utility (option 3.7).	189
Download ISPF C/S component	189

Download/upload data set	192
Outlist utility (option 3.8)	193
Outlist Utility panel action bar	194
Outlist Utility panel fields	194
Outlist utility options.	195
Command table utility (option 3.9)	196
Command Table Utility panel fields	197
Scrolling a command table	200
Saving a command table	200
Canceling a command table	200
Using command table line commands	200
Format specifications utility (option 3.11)	201
Format Specifications panel action bar	202
Format Specifications panel fields	202
Format Specifications panel options	203
Format selection list commands	206
SuperC utility (option 3.12).	207
SuperC Compare Utility panel action bar	208
SuperC Compare Utility panel fields	208
SuperC member lists	213
Submitting a SuperC job in batch mode	214
Using the NOLIST listing type in batch mode	216
SuperCE utility (option 3.13)	217
SuperCE Utility panel action bar	218
SuperCE Utility panel fields	218
SuperCE utility options	222
Search-For utility (option 3.14).	230
Search-For Utility panel action bar	231
Search-For Utility panel fields	231
Specifying additional search strings	233
Search-For strings and keywords	233
Search-For member lists	235
Submitting a Search-For job in batch mode	236
Search-ForE utility (option 3.15)	236
Search-ForE Utility panel action bar	237
Search-ForE Utility panel fields	237
ISPF table utility (option 3.16)	243
Table Utility panel action bar	244
Table Utility panel fields.	244
Table utility entry panel options	245
Table data set selection list	245
Table DD selection list	247
Edit/browse table panel.	248
Table output data set selection.	260
Table utility options	261
Table export report options	262
Export data set attributes	264
Importing data into a table	265
Exporting data from a table	265
Processing tables that are currently open	266
z/OS UNIX directory list utility (option 3.17).	269
z/OS UNIX Directory List Utility panel action bar	270
z/OS UNIX Directory List Utility panel fields	271
z/OS UNIX Directory List Utility panel options	271
z/OS UNIX directory list utility line commands	279
z/OS UNIX directory list utility primary commands	308
z/OS UNIX directory list options panels	313
Switching to super-user (UID 0) mode and back	317

Switching UIDs with the Options pull-down menu	317
Switching UIDs with the SU primary command	318

Chapter 6. Foreground (option 4) 319

Foreground selection panel action bar	319
Foreground processing sequence	320
Expanding packed data	323
Member expansion (ISRLEMEX)	324
Restrictions on member expansion and member parts lists.	324
Member expansion ISRLEMEX return codes	326
Trigger statement errors	326
Input data sets	326
List data sets	327
Password protection	328
Object data sets.	328
Foreground—TSO/E information center facility	329
Assembler (option 4.1)	329
COBOL (option 4.2)	330
VS FORTRAN compile (option 4.3)	331
PL/I (option 4.5)	332
VS Pascal compile (option 4.6).	333
Binder/linkage editor (option 4.7)	334
Linkage editor concatenation sequence	336
SCRIPT/VS processor (option 4.9)	336
SCRIPT/VS processing sequence	337
Selecting a formatting style.	340
Changing style options	341
Using SCRIPT/VS with the TSO/E information center facility	342
VS COBOL II interactive debug (option 4.10)	343
OS/VS COBOL debug (option 4.10A)	343
COBOL debug processing sequence	344
Symbolic debug data sets	345
Print output data sets	345
FORTRAN debug (option 4.11)	346
Member parts list (option 4.12)	347
Member not found	351
C/370 compile (option 4.13)	351
REXX/370 compile (option 4.14)	351
Ada/370 compile (option 4.15)	352
AD/Cycle C/370 compile (option 4.16).	352
ISPDTLC (option 4.18)	352
OS/390 C/C++ compile (option 4.19)	352

Chapter 7. Batch (option 5) 353

Batch selection panel action bar	353
Batch processing sequence	354
JCL generation—compilers	356
JCL generation—assemblers and linkage editor	358
Assembler (option 5.1)	358
COBOL compile (option 5.2)	359
VS FORTRAN compile (option 5.3)	360
PL/I compile (option 5.5)	361
VS Pascal compile (option 5.6).	361
Binder/linkage editor (option 5.7)	362
VS COBOL II interactive debug (option 5.10)	364
Member parts list (option 5.12)	365
C/370 compile (option 5.13)	365

REXX/370 compile (option 5.14)	365
Ada/370 compile (option 5.15)	366
AD/Cycle C/370 compile (option 5.16).	366
ISPDTLC compile (option 5.18)	366
OS/390 C/C++ compile (option 5.19)	366

Chapter 8. Command (option 6) 367

ISPF command shell panel action bar	367
The saved command area	369
Entering TSO commands, CLISTs, and REXX EXECs.	369
Rules for entering TSO commands	369
Rules for entering CLISTs and REXX EXECs	370
Using the session manager	370

Chapter 9. Dialog test (option 7) 373

The dialog test environment	373
Dialog test primary option panel action bar	375
Using variables.	376
Severe error handling	376
Commands	377
Ending the current option without saving changes	378
Saving changes.	379
Finding a character string	379
Displaying breakpoint qualification data	379
Restoring the format of the Breakpoints panel	379
Dialog test line commands	379
Setting a keylist for dialog test	380
Functions (option 7.1)	381
Invoke dialog function/selection panel action bar	382
Invoke dialog panel fields	382
Panels (option 7.2).	384
Display panel action bar.	385
Display panel fields	385
Variables (Option 7.3)	387
Variables panel action bar	388
Variables panel fields.	388
Variables commands	389
Manipulating variables	389
Variables usage notes.	390
Tables (option 7.4).	391
Tables panel action bar	392
Tables panel fields.	393
Tables panel options	394
Log (option 7.5)	404
ISPF transaction log not available.	405
Trace output in ispf log	405
Dialog services (option 7.6).	407
Invoke dialog service panel action bar	408
Special display panel.	409
Traces (option 7.7).	409
1—function traces	410
2—variable traces	412
Breakpoints (option 7.8)	413
Specifying breakpoints	414
Breakpoints panel action bar	414
Breakpoints panel fields	415
Qualification parameter values	415

Finding a breakpoint	417
Tutorial (option 7.T)	420
Exit (option 7.X)	420

Chapter 10. IBM products (option 9) 421

Chapter 11. SCLM (option 10) 423

SCLM Main Menu action bar	423
SCLM overview	424

Chapter 12. ISPF object/action workplace (option 11) 425

Selecting objects	425
Workplace entry panel	425
Specifying actions	428
Choices on the Workplace action bar	428
Actions that require prompt windows for more information	439
Commands	447
Default CUA function key settings	448
Changing workplace settings	449
Workplace example scenario	453

Appendix A. SuperC reference 457

Utility differences	457
Standard utilities	457
Extended utilities	457
Program description	458
SuperC features for the year 2000 transition	459
Applications.	459
Process options.	461
Process statements.	472
Change listing value	474
Change text	474
Comment lines	475
Compare byte offsets.	476
Compare (search) columns	477
Compare lines	478
Compare sections	479
Define column headings.	481
Do not process lines	482
Exclude data	484
Focus on data	484
Line count	485
List columns	486
List previous-search-following value.	486
Revision code reference	486
Search strings in the input file.	487
Select PDS members	489
Statements file listing control	490
Title alternative listing	490
Work size	491
Year aging	491
Date definitions	492
Global date	494
Reasons for differing comparison results	495
Return codes	496
SuperC and search-for technical overview	497
How SuperC and search-for filter input file lines	497
How SuperC matches input files	498

How SuperC partitions and processes large files	500
Comparing and searching alias members	500
Comparing load modules	501
Comparing CSECTs	501
How to directly invoke SuperC and search-for	501

Appendix B. Understanding the listings 505

General listing format	505
How to view the listing output	505
The comparison listing	505
Page headings	505
Listing output section	506
Member summary section	508
Overall summary section	510
Examples of comparison listings	511
The search listing	517
Page heading	517
Source lines section	518
Summary section	521
Examples of search listings	522

Appendix C. Update files 527

Revision file	528
Revision file (2)	529
Update CMS sequenced 8 file	529
Update control files	530

Update control file (LINE Compare Type)	531
Update control file (WORD compare type)	532
Update control file (BYTE compare type)	533
Update long control	534
Update MVS sequenced 8 file	534
Update prefixed delta lines	535
Update sequenced 0 file	536
Update summary only files	537
Update summary only file (LINE compare type)	537
Update summary only file (WORD compare type)	538
Update summary only file (BYTE compare type)	539

Appendix D. Accessibility 541

Accessibility features	541
Using assistive technologies	541
Keyboard navigation of the user interface	541
Dotted decimal syntax diagrams	541

Notices 545

Policy for unsupported hardware	546
Minimum supported hardware	547
Programming Interface Information	547
Trademarks	547

Index 549

Figures

1. Sample syntax diagram	xv	43. Color change panel with drop-down list	54
2. ISPF Primary Option Menu (ISR@PRIM)	1	44. CUA Attribute Change Utility panel (ISPOPT11).	55
3. Status pull-down on the ISPF Primary Option Menu (ISR@PRIM)	6	45. CUA Attribute Change Utility panel positioned on the point-and-shoot panel element (ISPOPT1X)	57
4. ISPF Primary Option Menu status area – session view	7	46. ISPF ENVIRON Settings panel (ISPENVA)	58
5. System information pop-up	8	47. Multi-Logon Profile Sharing Settings (ISPISSA)	59
6. Environment pop-up (release information)	9	48. Workstation pull-down on the ISPF settings panel action bar (ISPISMMN)	60
7. ISPF Primary Option Menu status area – function keys view	10	49. The Workstation Agent window.	60
8. ISPF Primary Option Menu status area – calendar view	10	50. Initiate Workstation Connection panel (ISPISMG1).	61
9. Julian date pop-up	11	51. WSA connection panel	64
10. Standard date pop-up	12	52. Client/Server Component Update panel (ISPDTVD1)	65
11. ISPF Primary Option Menu status area – user status view.	12	53. Client/Server Component Install Program panel (ISPWSD0A)	66
12. ISPF Primary Option Menu status area – user point-and-shoot view	13	54. GUI settings pop-up window (ISPISMG5)	67
13. ISPF status pop-up (ISPSAMMN)	14	55. ISPF Workstation Tool Integration panel	69
14. Status pull-down in ISPF status pop-up	15	56. Modify Tool Configuration window	70
15. Options pull-down in ISPF status pop-up	16	57. Extension Mapping Dialog window	71
16. Calendar month pop-up window	17	58. Identifier pull-down on the ispf settings panel action bar (ISPISMMN)	72
17. Calendar year pop-up window	17	59. Panel displayed with the message identifier set to on.	73
18. Calendar start pop-up window	18	60. Panel displayed with the system name set to on.	73
19. Calendar time format pop-up window	18	61. Panel displayed with the user ID set to on	74
20. Calendar colors panel (ISPCALGC)	19	62. Panel displayed with the panel identifier set to on.	75
21. User view customization panel (ISPSAMUS)	20	63. Panel displayed with the screen identifier set to on.	76
22. User point-and-shoot panel (ISPSAMUP)	21	64. View Entry panel (ISRBRO01)	77
23. ISPF Settings panel (ISPISMMN)	23	65. Browse - data display (ISRBROBA).	80
24. Screen containing graphics to be printed using PRINTG	29	66. Browse - column-identification line (ISRBROBA)	83
25. Example of using aspect ratio parameter 0	29	67. Browse hexadecimal display - vertical (ISRBROBA)	91
26. Example of using aspect ratio parameter 1	30	68. Browse hexadecimal display - data (ISRBROBA)	91
27. Log Data Set Defaults panel (ISPISML1)	33	69. Edit Entry panel (ISREDM01)	96
28. List Data Set Defaults panel (ISPISML2)	34	70. Utility Selection Panel (ISRUTIL)	101
29. List Data Set Characteristics panel (ISPISML3)	36	71. Library Utility panel (ISRUDA1)	102
30. Log and List JCL panel (ISPISMLJ).	37	72. Member list commands pop-up window (ISRCMLEP)	103
31. Function keys pull-down on the ISPF settings panel action bar (ISPISMMN)	39	73. Data Set Information panel (ISRUAIIP)	105
32. PF Key Definitions and Labels panel (ISPOPT3D)	40	74. Volume Information for a Multivolume Data Set (ISRUAMVI)	106
33. Using the PF Key Definitions and Labels panel (ISPOPT3E)	42	75. Data Set Information for PDSE Managed Data Sets (ISRUAISE)	107
34. Example screen with function key definition lines	42	76. Data Set Information for Managed Data Sets (ISRUAISE)	107
35. Keylist Utility panel (ISPKLUP).	43	77. Volume Information for a Managed Multivolume Data Set (ISRUAMVI)	108
36. Keylist Create panel (ISPKLUCR)	44	78. Short data set information (ISRUAIIP)	109
37. Keylist Change panel (ISPKLUCH).	46		
38. Keylist utility view panel (ISPKLUB)	47		
39. Keylist utility with delete keylist confirmation pop-up (ISPKLUP)	48		
40. Tailor Function Key Definition Display panel (ISPOPFA)	49		
41. Global Color Change Utility panel (ISPOPT10)	52		
42. Global GUI color change utility panel (ISPOPTG1)	53		

79. Data Set Information (Short) for Managed Data Sets (ISRUAISE)	110	121. Format Specifications panel (ISRFM01)	202
80. Data Set Information (Short) for a PDSE (ISRUAISE)	111	122. Format Definition panel (ISRFM02)	203
81. Data Set Utility panel (ISRUUDA2S)	113	123. Copy Format Selection List panel (ISRFM04)	205
82. Allocate New Data Set panel (ISRUAAP2)	115	124. Format Selection List panel (ISRFM03)	205
83. Allocate New Data Set —managed data set support panel (ISRUAAASE)	116	125. SuperC Utility panel (ISRSSNEW).	208
84. Multivolume allocation panel (ISRUAMV)	121	126. SuperC Utility - Old Data Set panel (ISRSSOLD)	210
85. Allocation Error Panel (ISRUADCS)	122	127. SuperC member list panel (ISRSSML)	213
86. Confirm Delete panel (ISRUADC1)	125	128. SuperC Utility - Submit Batch Jobs panel (ISRSCSUB)	214
87. Confirm purge panel (ISRUADC3)	126	129. SuperC Utility - submit batch jobs panel using NOLIST (ISRSCSB1)	217
88. VSAM Utilities panel (ISRUVSAM)	128	130. SuperCE Utility panel (ISRSEPRI).	218
89. Define Cluster panel (ISRUVPC3).	130	131. SuperCE - concatenation interactive entry panel (ISRSECAT)	223
90. Editing the IDCAMS command (ISRUVEDT)	131	132. SuperCE - Concatenation Batch Entry panel (ISRSECAT)	224
91. Browsing IDCAMS Errors (ISRUVBRO)	131	133. SuperC process statements panel (ISRSEPRS)	226
92. Using a VSAM profile data set (ISRVMLGT)	132	134. Browse a SuperCE profile	227
93. Panel for changing the name of the VSAM profile data set (ISRUVGET)	133	135. SuperCE - Profile Manager panel (ISRSEPMG)	228
94. Move/Copy Utility panel (ISRUMC1)	133	136. SuperC - Defaults panel (ISRSDFLT)	230
95. Move/Copy Utility - "To" panel for copying (ISRUMC2B)	135	137. Search-For Utility panel (ISRSFSPR)	231
96. Move/Copy Utility - "To" panel for moving (ISRUMC2B)	137	138. Additional Search Strings panel (ISRSFSST)	233
97. Data Set List Utility panel (ISRUDDL)	141	139. Search member list panel (ISRSSML)	235
98. Sequence of data set list display views	145	140. Search-For Utility - Submit Batch Jobs panel (ISRSFSUB)	236
99. Data set list - volume view (ISRUDSL0)	149	141. Extended Search-For Utility panel (ISRSFPRI)	237
100. Data set list - space view (ISRUDSL0)	151	142. Extended Search-For - concatenation data set entry panel (ISRSFCON)	240
101. Data set list - attributes view (ISRUDSL0)	151	143. Extended Search-For - concatenation batch entry panel (ISRSFCON)	241
102. Data set list - total view (ISRUDSL0)	152	144. Search-For process statements panel (ISRSFPRS)	243
103. Data set list - total view with catalog name (ISRUDSL0)	152	145. ISPF Table Utility panel (ISRUTBP0)	244
104. VTOC summary information panel (ISRUDDL)	161	146. Table data set selection list panel (ISRUTBP1)	246
105. Data set list commands pop-up (ISRUDDL)	164	147. Table DD selection list panel (ISRUTBP2)	247
106. Member list display - expanded line command field (ISRUDDL)	166	148. Table display panel, edit mode (ISRUTBP3)	248
107. Load module library display - expanded line command field (ISRUDDL)	166	149. Extension Variables Panel (ISRUTBP4)	250
108. Data Set List Color Change Utility panel (ISRUDDL)	173	150. Table Export Layout panel (ISRUTBP7)	253
109. Data Set List Utility - SHOWCMD panel (ISRUDDL)	177	151. Table Sort Specification panel (ISRUTBP8)	257
110. Reset ISPF Statistics panel (ISRUDDL)	180	152. Table statistics panel (ISRUTBP6)	258
111. Hardcopy Utility panel - before JCL generation (ISRUDDL)	184	153. Table structure panel (ISRUTBP5)	259
112. Hardcopy Utility panel - after JCL generation (ISRUDDL)	186	154. Table Output Data Set Selection panel (ISRUTBP9)	261
113. Hardcopy Utility panel - with the TSO/E information center facility installed (ISRUDDL)	188	155. Table Export Report Options panel (ISRUDDL)	263
114. ISPF Client/Server Component Download panel (ISPUDDL)	189	156. Table Export Data Set Attributes panel (ISRUDDL)	264
115. ISPF Client/Server Installation Notice (ISPUDDL)	191	157. Export report example	266
116. ISPF Client/Server Component Install Program panel (ISPUDDL)	192	158. Panel displayed when the selected table is currently open but not in SHARE mode	267
117. ISPF data set panel (ISPUDDL)	193	159. Panel displayed when the selected table is currently open in SHARE mode for NOWRITE	267
118. Outlist Utility panel (ISRUDDL)	194	160. Panel displayed when the selected table is currently open in SHARE mode for WRITE	268
119. Command Table Utility panel (ISPUDDL)	197	161. z/OS UNIX Directory List Utility panel (ISRUDDL)	270
120. Command table editing panel (ISPUDDL)	198	162. z/OS UNIX Directory List panel (ISRUDDL0)	272
		163. z/OS UNIX Directory List—scrolling right	273

164. Example: specifying a z/OS UNIX command to run on a selected file	278	199. Foreground Member Parts List panel (ISRFP12)	348
165. Example: running the selected file directly	278	200. Member parts list display (ISRFP12B)	350
166. Example: specifying a REXX exec to run on a selected file	279	201. Foreground ISPD TLC compile panel (ISPCP01) Screen 1.	352
167. z/OS UNIX Directory List Actions pop-up window	280	202. Batch Selection panel (ISRJPA)	353
168. Modify z/OS UNIX File Auditor Audit Options panel (ISRUULAA).	281	203. Batch Selection Panel with JCL generated (ISRJPB)	356
169. Copy From z/OS UNIX File panel (ISRUULCF)	282	204. Batch Assembler panel (ISRJP01)	358
170. Copy From z/OS UNIX Directory panel (ISRUULCD).	284	205. Batch COBOL Compile panel (ISRJP02)	359
171. Replace z/OS UNIX File panel (ISRUULRF)	287	206. Batch VS FORTRAN Compile panel (ISRJP03)	360
172. Copy Into z/OS UNIX Directory panel (ISRUULRD).	288	207. Batch PL/I Compile panel (ISRJP05)	361
173. z/OS UNIX File System Attributes panel (ISRUULFS)	292	208. Batch VS Pascal Compile panel (ISRJP06)	362
174. z/OS UNIX File Information panel (ISRUULIN)	295	209. Batch Binder Linkage/Editor panel (ISRJP07B)	363
175. z/OS UNIX Symbolic Link Information panel (ISRUULIS)	298	210. VS COBOL II Interactive Debug panel (ISRJP10)	364
176. Modify z/OS UNIX ACL list panel (ISRUULMA)	299	211. Batch Member Parts List panel (ISRJP12)	365
177. Modify z/OS UNIX File Format panel (ISRUULMF).	300	212. ISPF Command Shell panel (ISRTSO)	367
178. Modify z/OS UNIX File Owning Group panel (ISRUULMG)	301	213. ISPF Command Shell panel with saved commands (ISRTSO)	369
179. Modify z/OS UNIX File Owning User panel (ISRUULMO)	303	214. Dialog test primary option panel (ISPYXD1)	374
180. Create New z/OS UNIX File panel (ISRUULNW)	304	215. Keylist change panel (ISPKLUCH)	380
181. Personal Data Set List Add pop-up panel	306	216. Invoke Dialog Function/Selection panel (ISPYFP)	381
182. Modify z/OS UNIX File User Audit Options panel (ISRUULUA)	306	217. Display panel (ISPYP1)	385
183. Foreground Selection Panel (ISRFP01)	319	218. Message display panel (ISPYVP2)	387
184. Foreground Print Options panel (ISRFP02)	322	219. Variables panel (ISPYVVPN)	388
185. Foreground Print Options panel with TSO/E information center facility (ISRFP03)	329	220. Tables panel (ISPYTPI)	392
186. Foreground Assembler panel (ISRFP04)	330	221. Display row panel (ISPYTPD)	395
187. Foreground COBOL Compile panel (ISRFP05)	331	222. Confirm table row delete panel (ISPYTPCD)	396
188. Foreground VS FORTRAN Compile panel (ISRFP06)	332	223. Modify row panel (ISPYTPM)	397
189. Foreground PL/I Optimizing Compile panel (ISRFP07)	333	224. Add row panel (ISPYTPA)	399
190. Foreground VS Pascal Compile panel (ISRFP08)	334	225. Structure of table panel (ISPYTPSR)	401
191. Foreground Binder/Linkage Editor panel (ISRFP09)	335	226. Status of table panel with table not open (ISPYTPS1)	402
192. SCRIPT/VS Processor panel (ISRFP10)	337	227. Status of table panel with table open (ISPYTPS1)	403
193. Foreground Print Options for Style panel (ISRFP11)	339	228. ISPF transaction log (ISPYLP1).	405
194. Select SCRIPT/VS Formatting Style panel (ISRFP12)	341	229. Invoke dialog service panel (ISPYD1)	407
195. SCRIPT/VS Options for Style: DRAFT panel (ISRFP13)	342	230. Special display panel (ISPYD2)	409
196. Foreground Print Options for Style panel with the TSO/E information center facility (ISRFP14)	343	231. Traces panel (ISPYR1)	410
197. COBOL Debug panel (ISRFP15)	344	232. Function traces panel (ISPYRFP)	411
198. FORTRAN Debug panel (ISRFP16)	347	233. Variable traces panel (ISPYRVP)	412
		234. Breakpoints panel (ISPYBP1)	414
		235. Breakpoints panel with qualification parameter values (ISPYBP2).	416
		236. Breakpoint Primary Option panel (ISPYXM1)	418
		237. Dialog Test Tutorial - first panel (ISP70000)	420
		238. Additional IBM Program Development Products Panel (ISRDIIS).	421
		239. SCLM Main Menu (FLMDMN)	423
		240. Workplace entry panel - library view (ISRWORK1).	426
		241. Workplace entry panel - data set view (ISRWORK)	427
		242. Reset statistics panel (ISRURSET)	440
		243. TSO command panel (ISRUTCES).	441
		244. WS command panel (ISRWCES).	442
		245. ISPF Command Shell panel (ISRTSO)	443
		246. Move panel (ISRUMVC)	444

247. Rename prompt panel (ISRURNAM)	445	271. Example of the XREF summary section of a search listing.	521
248. Rename data set panel (ISRUARP1)	446	272. Example of the search listing (single file)	522
249. Rename member panel (ISRUREN)	446	273. Example of IDPFIX search on file group	523
250. Workplace Settings panel (ISRUSETM)	450	274. Example of XREF search on file group for two strings	523
251. Priority for filtering input lines	498	275. Example of LMTO search on file group	524
252. Find match example	499	276. Example of XREF/LMTO search of file group	524
253. Example of page heading lines for the comparison listing	506	277. Example of LTO search on file group	525
254. Example of the listing output section of the comparison listing	506	278. Example of LPSF search on file group	525
255. Example of the member summary section of the comparison listing	509	279. The "Old" input file used in most of the update examples	527
256. Example of the overall summary section of the comparison listing	510	280. The "New" input file used in most of the update examples	527
257. Example of comparison listing with dates being compared.	511	281. Example of a UPDREV update file for SCRIPT/VS documents	528
258. Example of comparison listing with column headings (Using COLHEAD)	512	282. Example of a UPDREV update file for bookmaster documents	528
259. Example of a NARROW side-by-side listing	512	283. Example of a UPDCMS8 update file	530
260. Example of a NARROW side-by-side listing (with DLMDUP)	513	284. Example of a UPDCNTL update file using line compare type	531
261. Example of a WIDE side-by-side listing	514	285. Example of a UPDCNTL update file using WORD compare type	532
262. Example of a FILE comparison of a file group	515	286. Example of a UPDCNTL update file using BYTE compare type	533
263. Example of a FILE comparison of a file group (with LOCS)	516	287. Example of a UPDLDEL update file	534
264. Example of a WORD comparison	517	288. Example of a UPDMVS8 update file	535
265. Example of the page heading line for the search listing.	517	289. Example of a UPDPDEL update file	536
266. Example of the source lines section of a search listing.	518	290. Example of a UPDSEQ0 update file	536
267. Example of the IDPFIX source lines section of a search listing	519	291. Example of a UPDSUMO file using LINE compare type	537
268. Example of the LMTO source lines section of a search listing	519	292. Example of a UPDSUMO file using WORD compare type	538
269. Example of the XREF source lines section (with ANYC)	520	293. Example of a UPDSUMO file using BYTE compare type	539
270. Example of the summary section of a search listing	521		

Tables

1. CUA mode effect on panel display	25	17. Sort field names and associated sort sequence	312
2. CUA mode effect on top-row-displayed indicator	26	18. Expansion triggers and syntax	324
3. ISPKYLST key settings	38	19. ISRSCAN and ISRLEMX return codes	326
4. ISPHELP key settings	39	20. Foreground member parts list record formats	351
5. Default key settings	45	21. ISRSCAN and ISRLEMX return codes	357
6. Displaying forms of the function keys.	50	22. Workstation commands	447
7. Valid CUA attribute change values.	55	23. Workplace function key settings	448
8. Valid point-and-shoot change values	57	24. Summary of process options	461
9. TSO command/CLIST/REXX exec variables (output)	158	25. Summary of process statements	472
10. TSO command/CLIST/REXX exec additional variables (output)	160	26. SuperC return codes	496
11. TSO command/CLIST/REXX exec variables (input)	160	27. UPDCNTL update file format using LINE compare type	531
12. Sort fields for source libraries	178	28. UPDCNTL update file format using WORD compare type	532
13. SRCHFOR command search string examples	179	29. UPDCNTL update file format using BYTE compare type	533
14. Reset mod level and reset sequence numbers combinations.	183	30. UPDSUMO format using LINE compare type	538
15. Search-For process options	242	31. UPDSUMO format using WORD compare type.	538
16. Octal permission values	276	32. UPDSUMO format using BYTE compare type	539

Preface

This document provides reference and usage information for programmers who develop applications with ISPF. It also provides conceptual and functional descriptions of ISPF.

About this document

This document contains two parts.

The first part provides information about using ISPF options 0-11.

The second part contains the appendixes and provides:

- Descriptions of the SuperC and Search-For programs
- Descriptions and examples of the SuperC output listing formats.

Who should use this document

This document is for application programmers using ISPF. Users should be familiar with coding CLISTs, REXX EXECs, or programs in the MVS™ environment.

What is in this document

Chapter 1, “Primary Option Menu (POM),” on page 1 describes the ISPF Primary Option menu, including the main menu options and the status area.

Chapter 2, “Settings (option 0),” on page 23 describes the ISPF Settings panel and related pop-up windows.

Chapter 3, “View (option 1),” on page 77 describes how Browse (Option 1) allows you to display source data and listings stored in ISPF libraries or other partitioned or sequential data sets.

Chapter 4, “Edit (option 2),” on page 95 describes how Edit (Option 2) allows you to create, display, and change data stored in ISPF libraries or other partitioned or sequential data sets.

Chapter 5, “Utilities (option 3),” on page 101 describes the different functions for library, data set, and catalog maintenance.

Chapter 6, “Foreground (option 4),” on page 319 describes how Foreground (Option 4) allows ISPF to run the foreground processors.

Chapter 7, “Batch (option 5),” on page 353 describes how Batch (Option 5) allows ISPF to run the batch processors.

Chapter 8, “Command (option 6),” on page 367 describes Command (Option 6), and how ISPF allows you to enter TSO commands, CLISTs, and REXX EXECs on the Command line of any panel and in the **Line Command** field on data set list displays.

Chapter 9, “Dialog test (option 7),” on page 373 describes how to use Dialog Test (Option 7) for testing both complete ISPF applications and ISPF dialog parts, including functions, panels, variables, messages, tables, and skeletons.

Chapter 10, “IBM products (option 9),” on page 421 describes the other IBM® products that are supported as ISPF dialogs.

Chapter 11, “SCLM (option 10),” on page 423 provides an overview of the SCLM product.

Chapter 12, “ISPF object/action workplace (option 11),” on page 425 describes the Workplace option (Option 11).

“Return codes” on page 496 provides information about the SuperC return codes, process options, update data set control options, and process statements.

Appendix B, “Understanding the listings,” on page 505 describes and explains the kinds of listings you can produce using SuperC.

How to read the syntax diagrams

The syntactical structure of commands described in this document is shown by means of syntax diagrams.

Figure 1 on page xv shows a sample syntax diagram that includes the various notations used to indicate such things as whether:

- An item is a keyword or a variable.
- An item is required or optional.
- A choice is available.
- A default applies if you do not specify a value.
- You can repeat an item.

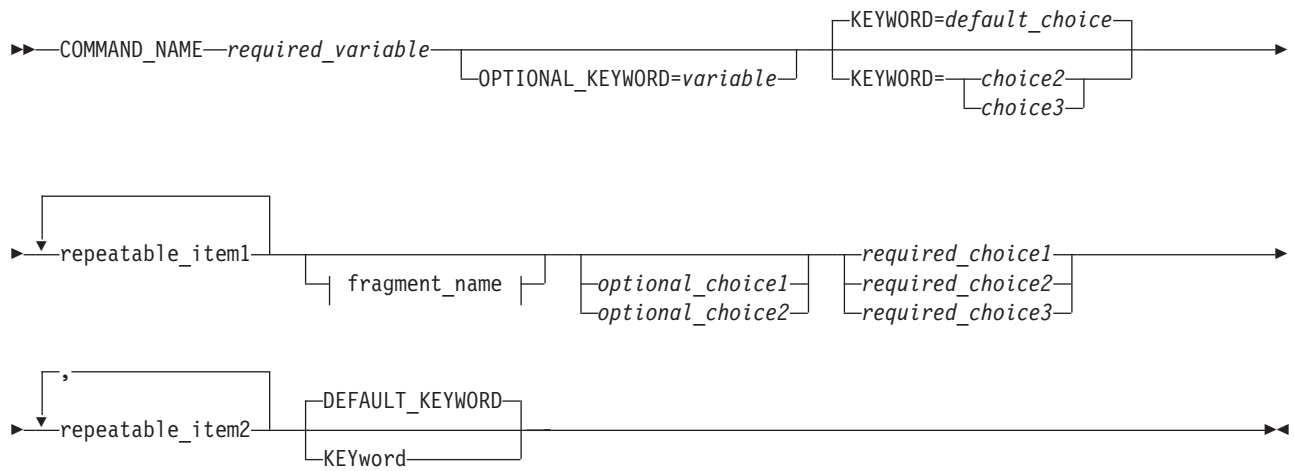

fragment_name:

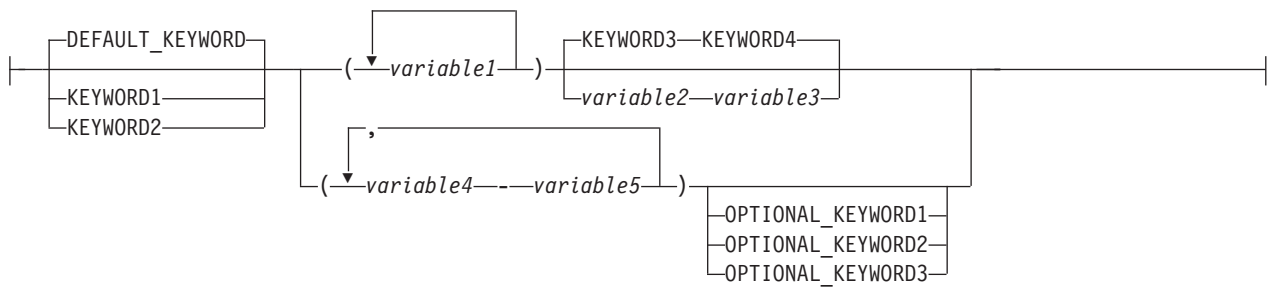

Figure 1. Sample syntax diagram

Here are some tips for reading and understanding syntax diagrams:

Order of reading

Read the syntax diagrams from left to right, from top to bottom, following the path of the line.

The \blacktriangleright symbol indicates the beginning of a statement.

The \longrightarrow symbol indicates that a statement is continued on the next line.

The \blacktriangleright symbol indicates that a statement is continued from the previous line.

The $\longrightarrow\blacktriangleleft$ symbol indicates the end of a statement.

Keywords

Keywords appear in uppercase letters.



Sometimes you only need to type the first few letters of a keyword, The required part of the keyword appears in uppercase letters.



In this example, you could type "KEY", "KEYW", "KEYWO", "KEYWOR" or "KEYWORD".

The abbreviated or whole keyword you enter must be spelled exactly as shown.

Variables

Variables appear in lowercase letters. They represent user-supplied names or values.

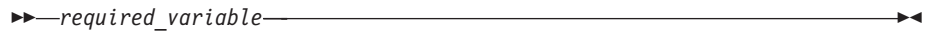

Required items

Required items appear on the horizontal line (the main path).



Optional items

Optional items appear below the main path.



Choice of items

If you can choose from two or more items, they appear vertically, in a stack.

If you *must* choose one of the items, one item of the stack appears on the main path.



If choosing one of the items is optional, the entire stack appears below the main path.



If a default value applies when you do not choose any of the items, the default value appears above the main path.



Repeatable items

An arrow returning to the left above the main line indicates an item that can be repeated.



If you need to specify a separator character (such as a comma) between repeatable items, the line with the arrow returning to the left shows the separator character you must specify.



Fragments

Where it makes the syntax diagram easier to read, a section or *fragment* of the syntax is sometimes shown separately.



⋮

fragment_name:



z/OS information

This information explains how z/OS references information in other documents and on the web.

When possible, this information uses cross-document links that go directly to the topic in reference using shortened versions of the document title. For complete titles and order numbers of the documents for all products that are part of z/OS®, see *z/OS Information Roadmap*.

To find the complete z/OS library, including the z/OS Information Center, see z/OS Internet Library (<http://www.ibm.com/systems/z/os/zos/bkserv/>).

How to send your comments to IBM

We appreciate your input on this publication. Feel free to comment on the clarity, accuracy, and completeness of the information or provide any other feedback that you have.

Use one of the following methods to send your comments:

1. Send an email to mhvrcfs@us.ibm.com.
2. Send an email from the "Contact us" web page for z/OS (<http://www.ibm.com/systems/z/os/zos/webqs.html>).
3. Mail the comments to the following address:
IBM Corporation
Attention: MHVRCFS Reader Comments
Department H6MA, Building 707
2455 South Road
Poughkeepsie, NY 12601-5400
US
4. Fax the comments to us, as follows:
From the United States and Canada: 1+845+432-9405
From all other countries: Your international access code +1+845+432-9405

Include the following information:

- Your name and address.
- Your email address.
- Your telephone or fax number.
- The publication title and order number:
z/OS V2R1.0 ISPF User's Guide Vol II
SC19-3628-00
- The topic and page number that is related to your comment.
- The text of your comment.

When you send comments to IBM, you grant IBM a nonexclusive right to use or distribute the comments in any way appropriate without incurring any obligation to you.

IBM or any other organizations use the personal information that you supply to contact you only about the issues that you submit.

If you have a technical problem

Do not use the feedback methods that are listed for sending comments. Instead, take one of the following actions:

- Contact your IBM service representative.
- Call IBM technical support.
- Visit the IBM Support Portal at z/OS support page (<http://www.ibm.com/systems/z/support/>).

Summary of changes

This summary lists changes and enhancements made in z/OS V2R1.0 ISPF. It has two parts:

Product function changes

Describes the functional changes made in z/OS V2R1.0 ISPF, listed by each ISPF component. This part appears in most of the ISPF documents.

Changes to this document

Lists the changes and enhancements made in z/OS V2R1.0 ISPF which affect this document, including cross-references to the new or changed sections.

Product function changes made in z/OS V2R1.0 ISPF

z/OS V2R1.0 ISPF contains the following changes and enhancements:

- “ISPF product changes”
- “ISPF Dialog Manager component changes” (including DTL changes)
- “ISPF PDF component changes” on page xxiv
- “ISPF SCLM component changes” on page xxiv
- “Migration considerations” on page xxiv

For details of migration actions relating to ISPF and other z/OS elements, see *z/OS Migration*.

ISPF product changes

There are no ISPF product changes relating to this release.

ISPF Dialog Manager component changes

The DM component of ISPF includes the following new functions and enhancements:

- Support is added for the processing of data sets allocated with an extended task I/O table (XTIOT) entry.
- The ISPF Services Guide is updated to include a new section documenting the format of JSON messages exchanged between TSO/ISPF and a client. This JSON API enables the user interface for an ISPF application to operate in the client environment.
- The ISPF Dialog Developers Guide and Reference is updated to describe ISPF variables that can be used by an application to pass information to the client by means of the JSON API.
- Support is provided for users to define a command stack to be run at ISPF invocation. This can be used to start multiple logical screens.
- Scroll amounts up to 9,999,999 are now supported.
- A new options panel allows a user to customize the display format for the SWAPBAR.
- Dialog Tag Language (DTL) changes:
There are no changes to Dialog Tag Language (DTL) for this release.

ISPF PDF component changes

The ISPF PDF component contains the following new functions and enhancements:

- The ISPF editor FIND and CHANGE commands have been enhanced to support regular expressions.
- The ISPF editor CREATE, REPLACE, COPY, MOVE, and CUT commands have been enhanced to support data conversion to/from EBCDIC, ASCII, and UTF-8.
- The ISPF editor HILITE command has been enhanced to show invalid use of lower-case characters in JCL.
- The member count field on member list panels is expanded to support values up to 9,999,999.
- The following enhancements have been made to the z/OS UNIX Directory List Utility:
 - Pattern matching characters can now be used to specify a path name filter for a z/OS UNIX directory list display.
 - A SRCHFOR command is provided to search for strings in regular files in the directory.
 - Directory list line commands can now be entered in blocks.
 - The file name column in the directory list can now have a display width of up to 110 characters.
 - A command shell is now provided allowing users to save and retrieve z/OS UNIX commands.
- The Data Set List Utility is changed to allow a path name to be entered in the Dsname Level field in order to have a z/OS UNIX Directory List displayed.
- The F (free) line command of the Data Set List Utility can now be used against a multi-volume data set to free unused space.
- The MEMLIST service supports the new DEFAULT keyword which allows the caller to specify a line command that is used to replace an “S” line command entered on the member list display.
- The ISPF editor provides support to view and edit Unicode data in data sets and z/OS UNIX files.
- The following enhancements have been made to the ISPF editor COMPARE command:
 - The VOL parameter is provided to support comparing against an uncataloged data set.
 - The target data set or path name can now be entered on the options panel displayed when the COMPARE command is entered without any parameters.
- To support the input of long editor commands, the editor command field can be expanded to a length of 255 characters using the ZEXPAND command.
- The UDLIST command is enhanced to convert the specified pathname to lowercase and re-issue the directory find if the directory for the pathname initially specified with the UDLIST command is not found.
- Data in the PROMPT column of the enhanced member list is now passed as an argument to a command entered against a member.

ISPF SCLM component changes

There are no ISPF SCLM component changes relating to this release.

Migration considerations

There are no migration considerations relating to this release.

Changes to this document for z/OS V2R1.0 ISPF

Note:

This book contains terminology, maintenance, and editorial changes. Technical changes or additions to the text and illustrations are indicated by a vertical line to the left of the change.

The "Readers' Comments - We'd Like to Hear from You" section at the back of this publication has been replaced with a new section "How to send your comments to IBM" on page xxi. The hardcopy mail-in form has been replaced with a page that provides information appropriate for submitting comments to IBM.

DSLISL Allocate

A DSLISL command is now available to allocate a data set. Also, DSLISL options that are not valid (for example, only NOT EXCLUDE commands are available against excluded data sets) are now disabled.

For changes to this document relating to this modification, see:

- Figure 105 on page 164
- "AL — Allocate" on page 170

Manage ACL

An MA (Modify ACL) line command has been added to the list of available commands on the 3.17 menu.

For changes to this document relating to this modification, see:

- "MA—modify ACL" on page 299

Support UNIX file format of RECORD

The file format RECORD has been added to ISPF UNIX file support.

What's in the z/OS V2R1.0 ISPF library?

You can order the ISPF books using the numbers provided below.

Title Order Number

z/OS ISPF Dialog Developer's Guide and Reference
SC19-3619-00

z/OS ISPF Dialog Tag Language Guide and Reference
SC19-3620-00

z/OS ISPF Edit and Edit Macros
SC19-3621-00

z/OS ISPF Messages and Codes
SC19-3622-00

z/OS ISPF Planning and Customizing
GC19-3623-00

z/OS ISPF Reference Summary
SC19-3624-00

z/OS ISPF Software Configuration and Library Manager Guide and Reference
SC19-3625-00

z/OS ISPF Services Guide
SC19-3626-00

z/OS ISPF User's Guide Vol I
SC19-3627-00

z/OS ISPF User's Guide Vol II
SC19-3628-00

Chapter 1. Primary Option Menu (POM)

See:

- “The Primary Option Menu panel”
- “Status area on the Primary Option Menu” on page 5

The Primary Option Menu panel

The Primary Option Menu panel, shown in Figure 2, is the first panel that displays when you start ISPF.

```
 2  Menu Utilities Compilers Options Status Help
                                     ISPF Primary Option Menu
 1
0 Settings      Terminal and user parameters
1 View          Display source data or listings
2 Edit          Create or change source data
3 Utilities      Perform utility functions
4 Foreground    Interactive language processing
5 Batch         Submit job for language processing
6 Command       Enter TSO or Workstation commands
7 Dialog Test   Perform dialog testing
9 IBM Products  IBM program development products
10 SCLM         SW Configuration Library Manager
11 Workplace    ISPF Object/Action Workplace
12 z/OS System  z/OS system programmer applications
13 z/OS User    z/OS user applications

                                     3
User ID . . : USERID
Time. . . : 13:54
Terminal. : 3278
Screen. . : 1
Language. : ENGLISH
Appl ID . : ISR
TSO logon : ISPF
TSO prefix: USERID
System ID : ISD1
MVS acct. : IBMGSA
Release . : ISPF 5.9

Enter X to Terminate using Log/List defaults

Option ==>
F1=Help      F2=Split   F3=Exit     F7=Backward F8=Forward  F9=Swap
F10=Actions  F12=Cancel
```

- 1** Primary Options.
- 2** Action bar choices.
- 3** Dynamic status area.

Figure 2. ISPF Primary Option Menu (ISR@PRIM)

ISPF primary options

When you select one of these options, ISPF displays the selected panel. These options are described in detail in other chapters within this book. Brief descriptions follow:

Option Description

- 0** **Settings** displays and changes selected ISPF parameters, such as terminal characteristics and function keys. See Chapter 2, “Settings (option 0),” on page 23 for more information.
- 1** **View** displays data (you cannot change it) using the View or Browse function. Use View or Browse to look at large data sets, such as compiler listings. You can scroll the data up, down, left, or right. If you are using

The Primary Option Menu panel

Browse, a FIND command, entered on the command line, allows you to search the data and find a character string. If you are using View, you can use all the commands and macros available to you in the Edit function. See Chapter 3, "View (option 1)," on page 77 for more information.

- 2 You can use **Edit** to create or change source data, such as program code and documentation, using the ISPF full-screen editor. You can scroll the data up, down, left, or right. You can change the data by using Edit *line commands*, which are entered directly on a line number, and *primary commands*, which are entered on the command line. See Chapter 3, "View (option 1)," on page 77 and refer to *z/OS ISPF Edit and Edit Macros* for more information.
- 3 **Utilities** perform library and data set maintenance tasks, such as moving or copying library or data set members, displaying or printing data set names and volume table of contents (VTOC) information, comparing data sets, and searching for strings of data. See Chapter 5, "Utilities (option 3)," on page 101 for more information.
- 4 **Foreground** calls IBM language processing programs in the foreground. See Chapter 6, "Foreground (option 4)," on page 319 for more information.
- 5 **Batch** calls IBM language processing programs as batch jobs. ISPF generates Job Control Language (JCL) based on information you enter and submits the job for processing. See Chapter 7, "Batch (option 5)," on page 353 for more information.
- 6 **Command** calls TSO commands, CLISTs, or REXX EXECs under ISPF. See Chapter 8, "Command (option 6)," on page 367 for more information.
- 7 **Dialog Test** tests individual ISPF dialog components, such as panels, messages, and dialog functions (programs, commands, menus). See Chapter 9, "Dialog test (option 7)," on page 373 for more information.
- 9 You can use the **IBM Products** option to select other installed IBM program development products on your system. Products supported are:
 - Tivoli® Information Management (INFOMAN)
 - COBOL Structuring Facility (COBOL/SF)
 - Screen Definition Facility II (SDF II and SDF II-P)See Chapter 10, "IBM products (option 9)," on page 421 for more information.
- 10 **SCLM** controls, maintains, and tracks all of the software components of an application. See Chapter 11, "SCLM (option 10)," on page 423 and refer to *z/OS ISPF Software Configuration and Library Manager Guide and Reference* for more information.
- 11 **Workplace** gives you access to the ISPF Workplace, which combines many of the ISPF functions onto one object-action panel. See Chapter 12, "ISPF object/action workplace (option 11)," on page 425 for more information.
- 12 **z/OS System** gives you access to the z/OS System Programmer Primary Option Menu. It contains options for z/OS elements that are used by system programmers and administrators. It includes options for:
 - GDDM® Print Queue Manager
 - HCD I/O configuration
 - APPC Administration
 - WLM Work Load Manager
 - FFST™ dump formatting

- Infoprint Server
 - RMF™
 - SMP/E
 - TCP/IP NPF
- 13 **z/OS User** gives you access to the z/OS Applications panel. It contains options for z/OS elements that are used by most ISPF users. It includes options for:
- BookManager® Build
 - BookManager Read
 - BookManager Index Creation
 - DFSMSrmm/ISMF
 - DFSMSdfp/ISMF
 - DFSORT
 - BDT File-to-File
 - IPCS
 - z/OS UNIX Browse
 - z/OS UNIX Edit
 - z/OS UNIX Shell
 - Security Server
 - TSO/E Information Center Facility
 - SDSF
- X **EXIT** leaves ISPF using the log and list defaults. You can change these defaults from the Log/List pull-down on the ISPF Settings panel action bar.

Primary Option Menu action bar choices

The Primary Option Menu action bar offers a quick way of accessing many of the panels within ISPF.

Menu This choice is available from most panels within ISPF and displays many of the options listed on the Primary Option Menu panel. These choices are available from the Menu pull-down:

Settings

Displays the ISPF Settings panel.

View Displays the View Entry panel.

Edit Displays the Edit Entry panel.

ISPF Command Shell

Displays the ISPF Command Shell panel.

Dialog Test

Displays the Dialog Test Primary Option panel.

Other IBM Products

Displays the Additional IBM Program Development Products panel.

SCLM Displays the SCLM Main Menu.

ISPF Workplace

Displays the Workplace entry panel.

The Primary Option Menu panel

Status Area

Displays the ISPF Status panel.

Exit Exits ISPF.

Utilities

This choice is available from many panels within ISPF and displays the options listed on the Utility Selection panel. These choices are available from the Utilities pull-down:

Library

Displays the Library Utility panel.

Data Set

Displays the Data Set Utility panel.

Move/Copy

Displays the Move/Copy Utility panel.

Data Set List

Displays the Data Set List Options panel.

Reset Statistics

Displays the Reset ISPF Statistics panel.

Hardcopy

Displays the Hardcopy Utility panel.

Download

Displays the panel that enables you to download workstation clients and other files from the host.

Outlist

Displays the Outlist Utility panel.

Commands

Displays the Command Table Utility panel.

Reserved

Reserved for future use by ISPF; an unavailable choice.

Format

Displays the Format Specification panel.

SuperC

Displays the SuperC Utility panel.

SuperCE

Displays the SuperCE Utility panel.

Search-for

Displays the Search-For Utility panel.

Search-forE

Displays the Search-ForE Utility panel.

Table Utility

Displays the ISPF Table Utility panel.

Compilers

The Compilers pull-down offers these choices:

- 1 Foreground Compilers** Displays the Foreground Selection Panel.
- 2 Background Compilers** Displays the Batch Selection Panel.

- 3 **ISPPREP Panel Utility** Displays the Preprocessed Panel Utility panel.
- 4 **DTL Compiler** Displays the ISPF Dialog Tag Language Conversion Utility panel.

Options

The Options pull-down offers these choices:

- 1 **General Settings** Displays the ISPF Settings panel.
- 2 **CUA Attributes** Displays the CUA Attribute Change Utility panel.
- 3 **Keylists** Displays the Keylist Utility panel.
- 4 **Point-and-Shoot** Displays the CUA Attribute Change Utility panel, positioned on the Point-and-Shoot panel element.
- 5 **Colors** Displays the Global Color Change Utility panel.
- 6 **Dialog Test appl ID** Displays the Dialog Test Application ID pop-up to allow you to change the application ID for Dialog test so that you can look at variables in the application profile for an application that runs under a different application ID than the one under which ISPF was started (by default, ISR).

Status The Status pull-down offers these choices:

- 1 **Session**
- 2 **Function keys**
- 3 **Calendar**
- 4 **User status**
- 5 **User point and shoot**
- 6 **None**

See “Status area on the Primary Option Menu” for more information about using these choices to tailor the status area.

Help The Help pull-down provides general information about ISPF topics and the changes in the current release, as well as information about each of the options and areas on the Primary Option Menu.

Status area on the Primary Option Menu

The status area on the ISPF Primary Option Menu is a 21-column dynamic area that is composed of a 12-character description field, one attribute byte, and an 8-character field to display the value of the selected variable. The status area is limited to eleven description fields and their values. It can be manipulated from two places:

- The Status choice on the ISPF Primary Option Menu action bar. Use this pull-down to specify *what* you want to display in the status area. See “Status pull-down” on page 6 for additional information and examples.
- The ISPF Status panel, which displays when you select Status Area from the Menu pull-down available on most action bars throughout ISPF. Use this facility to define the *contents* of the status area. See “Defining the status area” on page 13 for additional information and examples.

Note: The ISPF Status panel also contains an action bar choice called “Status”. This does *not* affect which Status option displays on the Primary Option Menu panel. It determines which Status option displays within the ISPF Status panel.

Status area on the Primary Option Menu

The first five logical screens, created by a SPLIT or related command, each have their own status view. For each screen after that, the view defaults to the setting of the first screen.

Status pull-down

When you select one of the choices in the Status pull-down on the ISPF Primary Option Menu action bar (shown in Figure 3), you specify what you want to display in the status area on the Primary Option Menu panel.

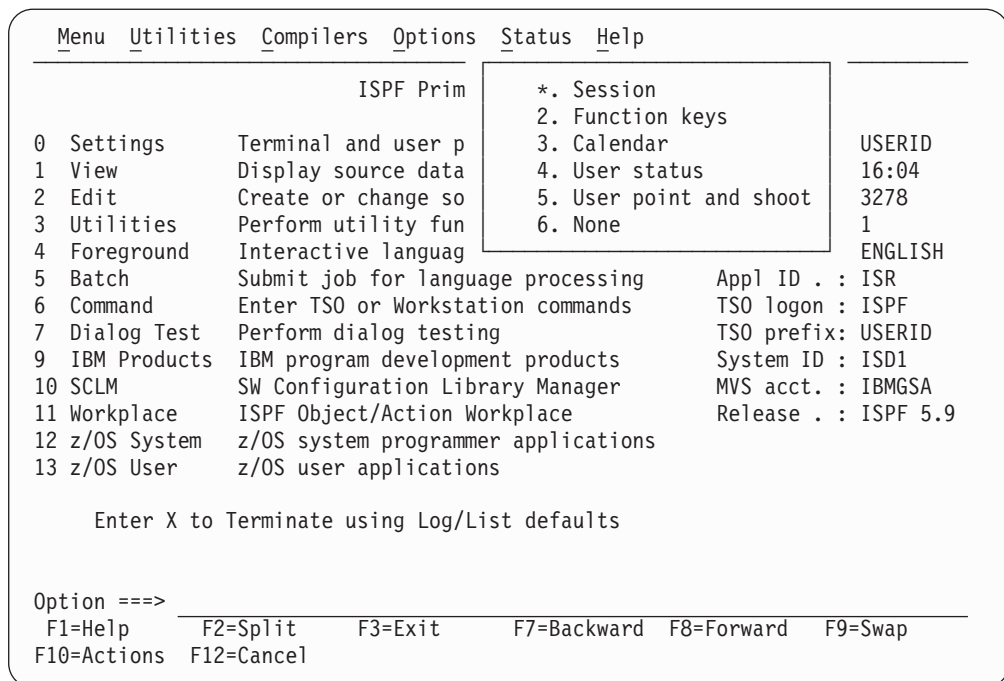

Figure 3. Status pull-down on the ISPF Primary Option Menu (ISR@PRIM)

Note: The current setting is shown as an unavailable choice; that is, displays in blue (the default) with an asterisk as the first digit of the selection number. If you are running in GUI mode the choice is *grayed*.

Session

The Session view, shown in Figure 4 on page 7, displays this information in the status area:

- User ID
- Time
- Terminal
- Screen
- Language
- Application ID
- TSO logon
- TSO prefix
- System ID
- MVS account
- Release.

Status area on the Primary Option Menu

```
Menu Utilities Compilers Options Status Help
-----
                                ISPF Primary Option Menu

0 Settings      Terminal and user parameters      User ID . . : USERID
1 View          Display source data or listings      Time. . . : 16:23
2 Edit          Create or change source data        Terminal. . : 3278
3 Utilities     Perform utility functions           Screen. . . : 1
4 Foreground    Interactive language processing     Language. . : ENGLISH
5 Batch         Submit job for language processing   Appl ID . . : ISR
6 Command       Enter TSO or Workstation commands    TSO logon : ISPF
7 Dialog Test   Perform dialog testing              TSO prefix: USERID
9 IBM Products  IBM program development products    System ID : ISD1
10 SCLM         SW Configuration Library Manager     MVS acct. : IBMGSA
11 Workplace    ISPF Object/Action Workplace        Release . . : ISPF 5.9
12 z/OS System  z/OS system programmer applications
13 z/OS User    z/OS user applications

Enter X to Terminate using Log/List defaults

Option ==> _____
F1=Help      F2=Split    F3=Exit     F7=Backward F8=Forward  F9=Swap
F10=Actions  F12=Cancel
```

Figure 4. ISPF Primary Option Menu status area – session view

System ID is a point-and-shoot field. **MVS Acct** and **Release** are point-and-shoot fields if over 8 characters long. Select these fields to display pop-up windows that contain additional information about the MVS account number and the ISPF environment.

MVS Acct

The account number identifying this MVS user.

System ID

Shows the **SYSPLEX** and **SYSNODE**.

SYSPLEX

The MVS sysplex name as found in the COUPLExx or LOADxx member of SYS1.PARMLIB.

SYSNODE

The network node name of your installation's JES.

Status area on the Primary Option Menu

```

Menu Utilities Compilers Options Status Help
----- System Information -----
SYSPLEX = SYSPLEXD
0  SYSNODE = PTHAPD$
1  F1=Help   F2=Split   F3=Exit
2  F9=Swap   F12=Cancel
3
4  Foreground Interactive language processing
5  Batch      Submit job for language processing
6  Command    Enter TSO or Workstation commands
7  Dialog Test Perform dialog testing
9  IBM Products IBM program development products
10 SCLM        SW Configuration Library Manager
11 Workplace  ISPF Object/Action Workplace
12 z/OS System z/OS system programmer applications
13 z/OS User   z/OS user applications

Enter X to Terminate using Log/List defaults

Option ==>
F1=Help   F2=Split   F3=Exit   F7=Backward F8=Forward F9=Swap
F10=Actions F12=Cancel
Option Menu
eters      User ID . . : SUEBURN
listings   Time. . . : 16:49
data       Terminal. . : 3278
ns         Screen. . . : 1
           Language. . : ENGLISH
           Appl ID . . : ISR
           TSO logon : ISPF
           TSO prefix: SUEBURN
           System ID : ISD1
           MVS acct. : IBMGSA
           Release . . : ISPF 5.9

```

Figure 5. System information pop-up

Release

Displays these variables:

- **ZOS390RL**— The z/OS Release running on your system.
- **ZISPFOS**— The level of ISPF code that is running as part of z/OS on your system. This might or might not match ZOS390RL.
- **ZENVIR**— The ISPF Environment description. See the table of system variables in the *z/OS ISPF Dialog Developer's Guide and Reference* for a complete explanation.

```

Menu Utilities Compilers Options Status Help
----- Environment -----
ZOS390RL = z/OS 01.04.00
0 The z/OS release running on your system.
1
2 ZISPFOS = ISPF FOR z/OS 01.05.00
3 The level of ISPF code that is running as part of z/OS on your
4 system. This might or might not match ZOS390RL.
5
6 ZENVIR = ISPF 5.5 MVS TSO
7 The ISPF Environment description used by IBM personnel for
9 internal purposes. The x.y numbers DO NOT directly correlate to
1 an ISPF release number in all cases. Refer to the Dialog
1 Developer's Guide for a complete explanation.
1
1 F1=Help F2=Split F3=Exit F9=Swap F12=Cancel
1
Option ==>
F1=Help F2=Split F3=Exit F7=Backward F8=Forward F9=Swap
F10=Actions F12=Cancel

```

Figure 6. Environment pop-up (release information)

Function keys

The Function Keys view, shown in Figure 7 on page 10, displays this information in the status area:

- Number of keys
- Keys displayed per line
- Primary range (lower or upper)
- Display set (primary or alternate)
- List name (name of the currently active keylist)
- List applid (application ID for the currently active keylist)
- List type (private or shared)
- Keylists (on or off).

Note: See “Working with function keys and keylists (the Function Keys action bar choice)” on page 37 for information about changing these settings.

Status area on the Primary Option Menu

```

Menu  Utilities  Compilers  Options  Status  Help
-----
                ISPF Primary Option Menu

0 Settings      Terminal and user parameters      No. of keys: 24
1 View          Display source data or listings   Keys / line: SIX
2 Edit          Create or change source data      Primary set: LOW
3 Utilities     Perform utility functions         Display set: PRI
4 Foreground    Interactive language processing   List name. : ISRSAB
5 Batch         Submit job for language processing List applid: ISR
6 Command       Enter TSO or Workstation commands List type. : SHARED
7 Dialog Test   Perform dialog testing            Keylists . : PRIVATE
9 IBM Products  IBM program development products
10 SCLM         SW Configuration Library Manager
11 Workplace    ISPF Object/Action Workplace
12 z/OS System  z/OS system programmer applications
13 z/OS User    z/OS user applications

Enter X to Terminate using Log/List defaults

Option ==>>
F1=Help      F2=Split    F3=Exit     F7=Backward F8=Forward  F9=Swap
F10=Actions  F12=Cancel

```

Figure 7. ISPF Primary Option Menu status area – function keys view

Calendar

The Calendar view, shown in Figure 8, displays the calendar for the current month in the status area.

```

Menu  Utilities  Compilers  Options  Status  Help
-----
                ISPF Primary Option Menu

0 Settings      Terminal and user parameters      <  Calendar  >
1 View          Display source data or listings   January 2003
2 Edit          Create or change source data      Su Mo Tu We Th Fr Sa
3 Utilities     Perform utility functions         1 2 3 4
4 Foreground    Interactive language processing   5 6 7 8 9 10 11
5 Batch         Submit job for language processing 12 13 14 15 16 17 18
6 Command       Enter TSO or Workstation commands 19 20 21 22 23 24 25
7 Dialog Test   Perform dialog testing            26 27 28 29 30 31
9 IBM Products  IBM program development products
10 SCLM         SW Configuration Library Manager
11 Workplace    ISPF Object/Action Workplace     Time . . . . : 05:00
12 z/OS System  z/OS system programmer applications Day of year. : 135
13 z/OS User    z/OS user applications

Enter X to Terminate using Log/List defaults

Option ==>>
F1=Help      F2=Split    F3=Exit     F7=Backward F8=Forward  F9=Swap
F10=Actions  F12=Cancel

```

Figure 8. ISPF Primary Option Menu status area – calendar view

All of the fields on the calendar are point-and-shoot fields that function as follows:

If you select

ISPF displays

< the previous month.

calendar

the current month.

> the next month.

Month, e.g. July

the Calendar Month pop-up. Allows you to specify the month. See “Customizing the calendar” on page 16 for details.

Year, e.g. 2003

the Calendar Year pop-up. Allows you to specify the year. See “Customizing the calendar” on page 16 for details.

Day

the Calendar Start Day pop-up. Allows you to specify Saturday, Sunday, or Monday as the start day for the calendar. See “Customizing the calendar” on page 16 for details.

Date

the Julian Date pop-up. Provides the Julian date for the date selected.

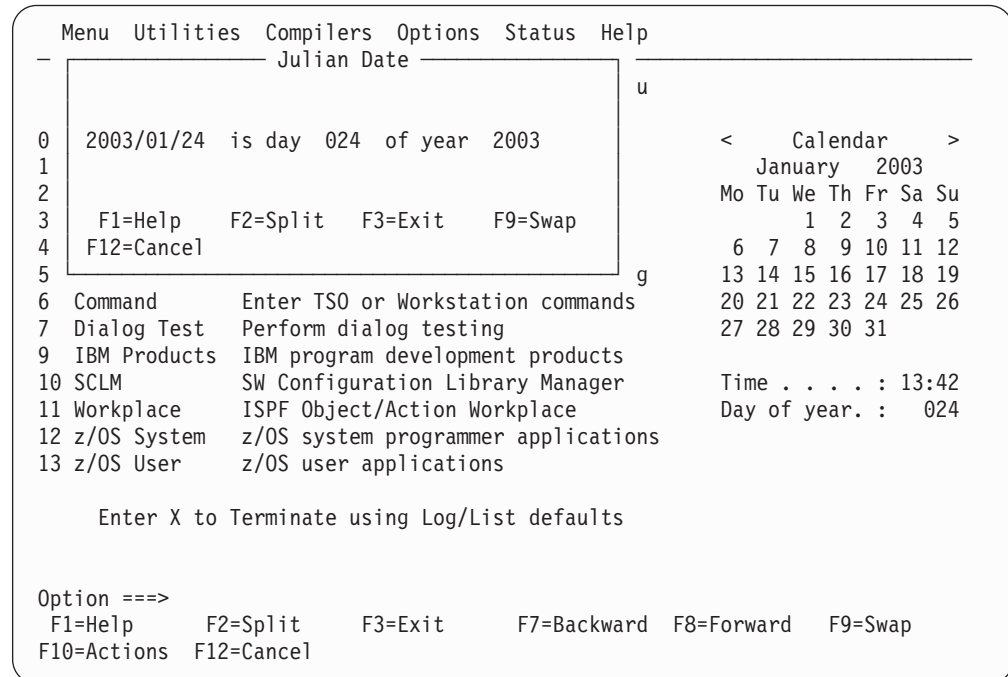

Figure 9. Julian date pop-up

Time

the Calendar Time Format pop-up. Allows you to specify a 12-hour or 24-hour time format for the calendar. See “Customizing the calendar” on page 16 for details.

Day of year

the Standard Date pop-up. Provides the standard date for the day specified in the popup (defaults to the date selected in the calendar).

Status area on the Primary Option Menu

```
Menu Utilities Compilers Options Status Help
----- Standard Date -----
0 Enter the day and year below: >
1                               003
2 Day . . . . 024 (Between 1 and 365 or 366 if leap year) Sa Su
3 Year . . . . 2003 (Between 1801 and 2099) 4 5
4                               11 12
5 Day 024 of year 2003 is Friday , 2003/01/24 18 19
6                               25 26
7
9 F1=Help F2=Split F3=Exit F7=Backward F8=Forward
1 F9=Swap F12=Cancel 13:47
1                               024

Enter X to Terminate using Log/List defaults

Option ==>
F1=Help F2=Split F3=Exit F7=Backward F8=Forward F9=Swap
F10=Actions F12=Cancel
```

Figure 10. Standard date pop-up

User status

The User Status view, shown in Figure 11, displays the status information that you have defined in the Status Area panel.

```
Menu Utilities Compilers Options Status Help
----- ISPF Primary Option Menu -----
0 Settings Terminal and user parameters User ID: USERID
1 View Display source data or listings Date: 24/01/03
2 Edit Create or change source data Time: 14:57
3 Utilities Perform utility functions
4 Foreground Interactive language processing
5 Batch Submit job for language processing
6 Command Enter TSO or Workstation commands
7 Dialog Test Perform dialog testing
9 IBM Products IBM program development products
10 SCLM SW Configuration Library Manager
11 Workplace ISPF Object/Action Workplace
12 z/OS System z/OS system programmer applications
13 z/OS User z/OS user applications

Enter X to Terminate using Log/List defaults

Option ==>
F1=Help F2=Split F3=Exit F7=Backward F8=Forward F9=Swap
F10=Actions F12=Cancel
```

Figure 11. ISPF Primary Option Menu status area – user status view

User point and shoot

The User Point-and-Shoot view, shown in Figure 12 on page 13, displays the point-and-shoot function you have defined in the Status Area panel.

Status area on the Primary Option Menu

Note: If you are running in GUI mode, this function will be displayed as a push button.

```

  Menu  Utilities  Compilers  Options  Status  Help
-----
                    ISPF Primary Option Menu

0 Settings      Terminal and user parameters          Dialog Test
1 View          Display source data or listings        Edit
2 Edit          Create or change source data          Edit Recovery Table
3 Utilities     Perform utility functions
4 Foreground    Interactive language processing
5 Batch         Submit job for language processing
6 Command       Enter TSO or Workstation commands
7 Dialog Test   Perform dialog testing
9 IBM Products  IBM program development products
10 SCLM         SW Configuration Library Manager
11 Workplace    ISPF Object/Action Workplace
12 z/OS System  z/OS system programmer applications
13 z/OS User    z/OS user applications

      Enter X to Terminate using Log/List defaults

Option ==>>
F1=Help      F2=Split    F3=Exit     F7=Backward F8=Forward  F9=Swap
F10=Actions  F12=Cancel

```

Figure 12. ISPF Primary Option Menu status area – user point-and-shoot view

None

If you select None from the Status pull-down, nothing will be displayed in the status area.

Defining the status area

When you select Status Area from the Menu pull-down, ISPF displays the ISPF Status pop-up window (shown in Figure 13 on page 14), with an independent view of the status area. This panel is used to define the contents of the status area choices. You can change the choice displayed in this window by using the Status pull-down on the action bar.

Note: Changing the status area viewed in this panel will *not* affect the choice selected on the ISPF Primary Option Menu panel.

Status area on the Primary Option Menu

```

Menu Utilities Compilers Options Status Help
-----
  Status Options
-----
0      ISPF Status
1
2
3      <  Calendar  >
4      January 2003
5      Su Mo Tu We Th Fr Sa
6              1 2 3 4
7      5 6 7 8 9 10 11
9      12 13 14 15 16 17 18
1      19 20 21 22 23 24 25
1      26 27 28 29 30 31

Time . . . . : 11:10
Day of year. : 024

Command ===>
F1=Help      F2=Split
F3=Exit

0

F10=Actions F12=Cancel

F Primary Option Menu
user parameters      User ID . . : USERID
e data or listings  Time. . . : 11:10
nge source data     Terminal. : 3278
ty functions        Screen. . : 1
anguage processing  Language. : ENGLISH
r language processing Appl ID . : ISR
Workstation commands TSO logon : ISPF
g testing           TSO prefix: USERID
evelopment products System ID : ISD1
ion Library Manager MVS acct. : IBMGSA
ction Workplace     Release . : ISPF 5.5

g Log/List defaults

Exit      F7=Backward F8=Forward F9=Swap

```

Figure 13. ISPF status pop-up (ISPSAMMN)

Status The Status pull-down, shown in Figure 14 on page 15, offers these choices:

- 1 Session
- 2 Function keys
- 3 Calendar
- 4 User status
- 5 User point and shoot
- 6 None

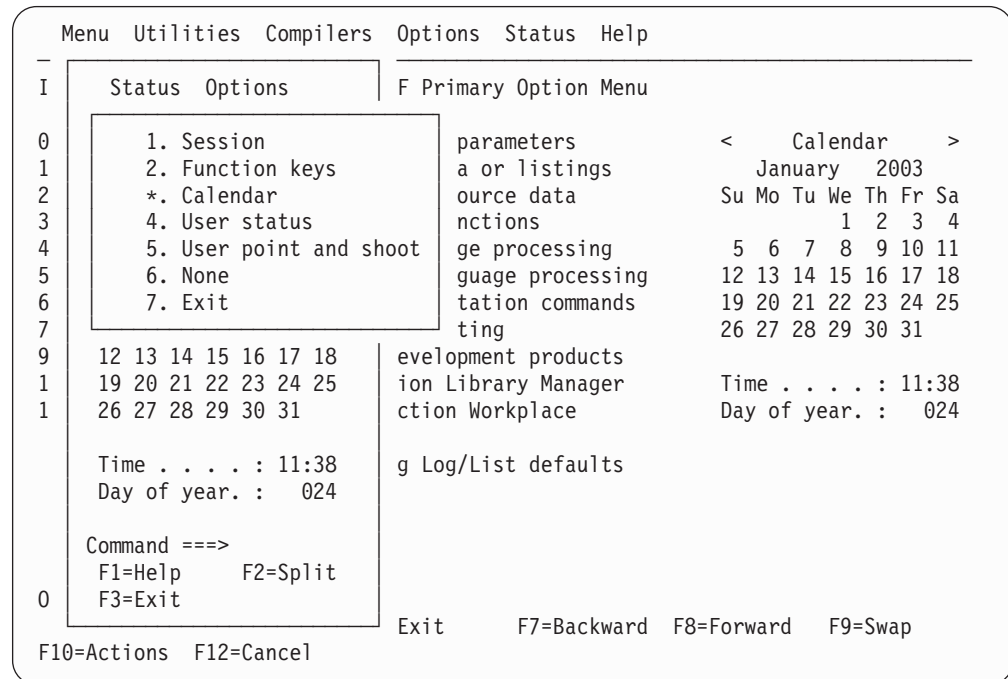

Figure 14. Status pull-down in ISPF status pop-up

Options

The Options pull-down, shown in Figure 15 on page 16, offers these choices:

- 1 **Calendar start day** Displays the Calendar Start Day pop-up, where you can specify Saturday, Sunday, or Monday as the start day for the calendar.
- 2 **Calendar colors** Displays the Calendar Colors pop-up, where you can change the colors on the calendar.
- 3 **User status customization** Displays the User View Customization pop-up, where you can define what you want displayed in the status area.
- 4 **User point and shoot customization** Displays the User Point and Shoot Customization pop-up, where you can define point-and-shoot fields to be displayed in the status area.

Status area on the Primary Option Menu

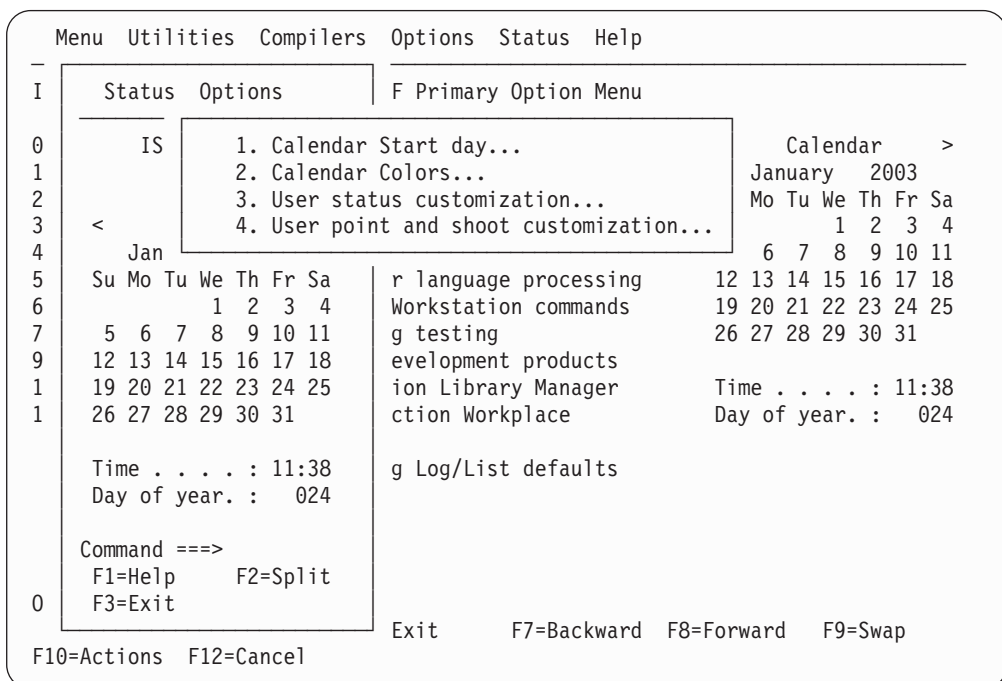

Figure 15. Options pull-down in ISPF status pop-up

Customizing the calendar

You can customize the calendar to show a different month, year or starting day. You can set the time display to a 12 or 24 hour clock. You can also customize the colors used to display the calendar.

Note:

- Changes to the month or year display will last for the current session only. Changes to the starting day and time format will be saved between sessions.
- You can use the point-and-shoot fields on the calendar displayed on the Primary Option Menu panel or in the Status Area pop-up. Changes made in either location will affect the display in both locations.

Changing the month display: You can change the month that displays in the calendar in a number of ways:

- Click the < or > symbols to display the previous or next month.
- Click the Calendar point-and-shoot field to display the current month.
- Set the month display to a particular month by selecting the month name point-and-shoot field and entering a number in the Calendar Month pop-up window:

```

Menu Utilities Compilers Options Status Help
----- Calendar Month -----
0  Month . . . 01  1. January
1                               2. February
2                               3. March
3                               4. April
4                               5. May
5                               6. June
6                               7. July
7                               8. August
9                               9. September
1                               10. October
1                               11. November
                               12. December

Select a choice and press ENTER
F1=Help      F2=Split
F3=Exit      F7=Backward

Option ==>
F1=Help      F2=Split      F3=Exit      F7=Backward  F8=Forward  F9=Swap
F10=Actions  F12=Cancel
    
```

Figure 16. Calendar month pop-up window

Changing the year display: You can change the year that displays in the calendar by selecting the year point-and-shoot field and entering the required year (between 1801 and 2099) in the Calendar Year pop-up window.

```

Menu Utilities Compilers Options Status Help
----- Calendar Year -----
0  Year . . .
1
2  Enter the year to display between 1801 and 2099
3
4  F1=Help      F2=Split      F3=Exit
5  F7=Backward  F8=Forward    F9=Swap
6
7  Dialog Test  Perform dialog testing
9  IBM Products IBM program development products
10 SCLM        SW Configuration Library Manager
11 Workplace   ISPF Object/Action Workplace
12 z/OS System z/OS system programmer applications
13 z/OS User   z/OS user applications

Enter X to Terminate using Log/List defaults

Option ==>
F1=Help      F2=Split      F3=Exit      F7=Backward  F8=Forward  F9=Swap
F10=Actions  F12=Cancel
    
```

Figure 17. Calendar year pop-up window

Changing the starting day: You can change the calendar display so that the weeks begin on a Saturday, Sunday, or Monday.

- To display the Calendar Start Day pop-up window, use either of these methods:
 - Select any day name point-and-shoot field (e.g. Mo or Tu).

Changing the calendar colors: To change the colors on the calendar:

1. From the ISPF Status action bar, select Options and then 2. Calendar colors. The Calendar Colors pop-up, Figure 20, is displayed.
2. Type a valid color number in the field next to each calendar element to be changed and press Enter. The color will change immediately in the Sample area.

To restore a default color, clear the element field and press Enter.

3. Press EXIT (F3) or END to exit and save the changes. Press CANCEL (F12) to exit without saving the changes.

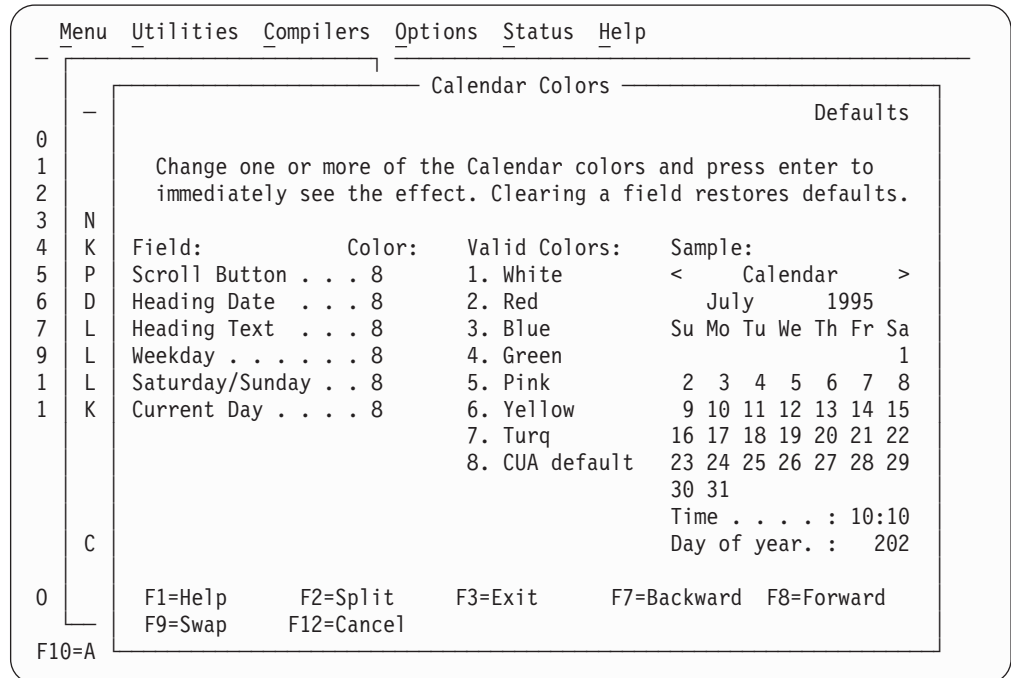

Figure 20. Calendar colors panel (ISPCALGC)

Customizing the user status area

To define the contents of this area:

1. From the ISPF Status action bar, select Options and then 3. User status customization. The User View Customization panel, Figure 21 on page 20, is displayed.

Status area on the Primary Option Menu

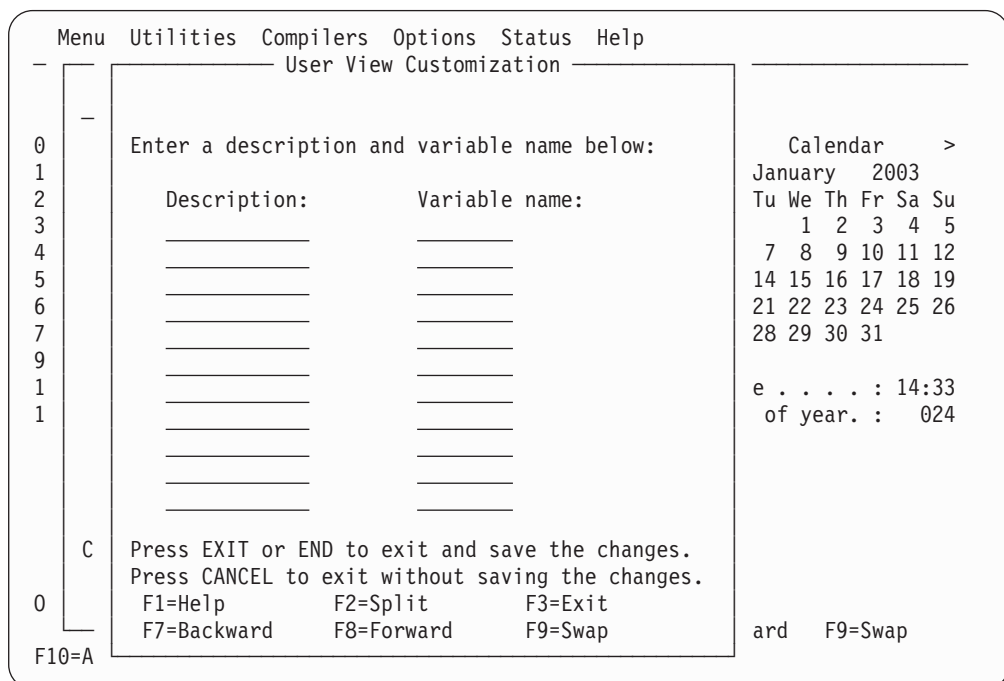

Figure 21. User view customization panel (ISPSAMUS)

2. Enter a heading in the Description field and the name of a System variable or site-defined variable in the Variable name field. See the *z/OS ISPF Dialog Developer's Guide and Reference* for a list of System Variable names.
3. Press EXIT (F3) or END to exit and save the changes. Press CANCEL (F12) to exit without saving the changes.

For example, entering:

```
Description:      Variable name:
User ID:         ZUSER
Date:           ZDATE
Time:           ZTIME
```

would result in the display shown in Figure 11 on page 12.

Customizing the user point-and-shoot status area

You can define up to nine point-and-shoot fields, which you can set to any SELECT service parameter. To do this:

1. From the ISPF Status action bar, select Options and then 4. User point and shoot customization. The User Point-and-Shoot panel, Figure 22 on page 21, is displayed.

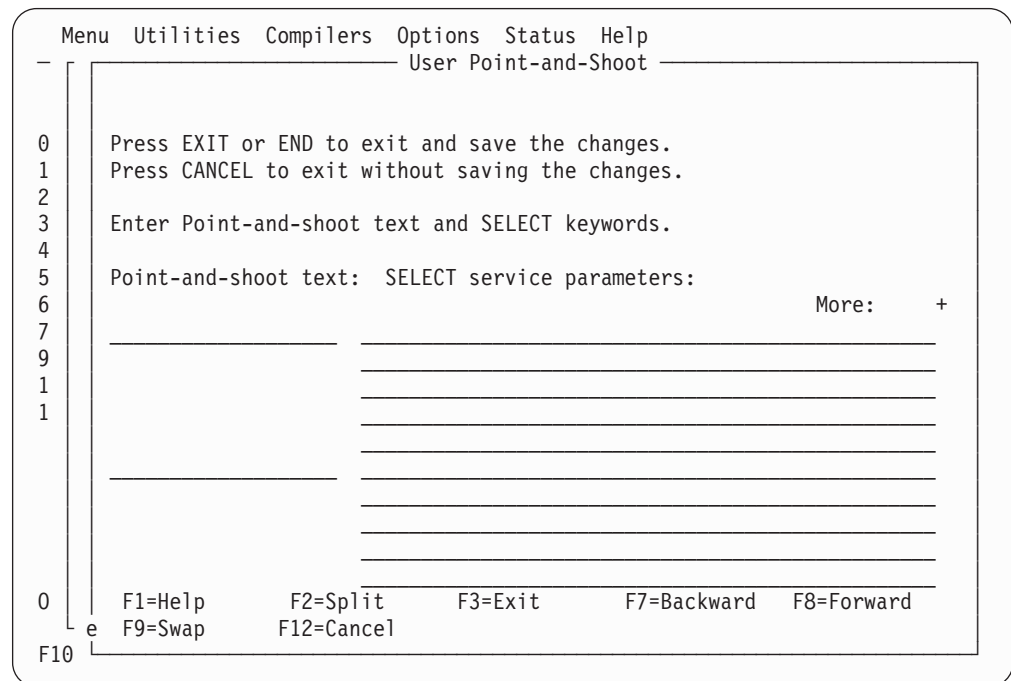

Figure 22. User point-and-shoot panel (ISPSAMUP)

2. Enter the text to appear in the status area, in the field on the left of the panel.
3. Enter the Service parameters to be invoked in the lines on the right of the panel. See *z/OS ISPF Services Guide* for information about these parameters.
4. Press EXIT (F3) or END to exit and save the changes. Press CANCEL (F12) to exit without saving the changes.

Status area on the Primary Option Menu

Chapter 2. Settings (option 0)

The Settings option allows you to display and change a variety of ISPF parameters at any time during the ISPF session. Changes remain in effect until you change the parameter again, and ISPF saves them from session to session. This topic explains how to use the fields on the ISPF Settings panel and the action bar choices.

If you select option 0 on the ISPF Primary Option Menu, this panel is displayed.

```

Log/List  Function keys  Colors  Environ  Workstation  Identifier  Help
-----
                          ISPF Settings

Options
Enter "/" to select option
/ Command line at bottom
[ Panel display CUA mode
- Long message in pop-up
- Tab to action bar choices
- Tab to point-and-shoot fields
[ Restore TEST/TRACE options
[ Session Manager mode
[ Jump from leader dots
- Edit PRINTDS Command
[ Always show split line
- Enable EURO sign
[ Scroll member list
- Allow empty member list
- Allow empty member list (nomatch)
[ Empty member list for edit only

Print Graphics
Family printer type 2
Device name . . . . _____
Aspect ratio . . . 0

General
Input field pad . . B
Command delimiter . ;

Terminal Characteristics
Screen format  2  1. Data    2. Std    3. Max    4. Part

Terminal Type  3  1. 3277    2. 3277A    3. 3278    4. 3278A
                5. 3290A    6. 3278T    7. 3278CF    8. 3277KN
                9. 3278KN   10. 3278AR   11. 3278CY   12. 3278HN
                13. 3278H0  14. 3278IS   15. 3278L2   16. BE163
                17. BE190   18. 3278TH   19. 3278CU   20. DEU78
                21. DEU78A  22. DEU78T   23. DEU90A   24. SW116
                25. SW131   26. SW500    27. 3278GR   28. 3278L1
                29. OTHER

Command ==>
F1=HELP      F2=SPLIT    F3=END      F4=RETURN   F5=RFIND    F6=RCHANGE
F7=UP        F8=DOWN     F9=SWAP     F10=LEFT    F11=RIGHT   F12=RETRIEVE

```

Figure 23. ISPF Settings panel (ISPISMMN)

This facility can also be started from any command line with the `SETTINGS` command, or from the Settings choice on the Menu pull-down on any action bar where it is available. Typically, the Settings facility should be included as an option on an application's primary option menu or as a choice on a pull-down on an application's primary option menu.

Some of the things you can specify are:

- Terminal characteristics
- Default options for processing the ISPF list and log data sets
- Function key assignments

Settings (option 0)

- Placement of command lines
- List data set characteristics
- GDDM graphic print parameters
- Keylist modifications
- Dialog Test option
- Default colors
- Values of CUA panel elements
- Point-and-shoot color and highlight changes
- ENVIRON command options.

ISPF Settings panel fields

Figure 23 on page 23 shows the initial default ISPF Settings. The display or the field-level help indicates the allowable alternatives for these defaults. The values shown in Figure 23 on page 23 are for an ISPF session in the English language. The corresponding panel displayed for a non-English session is similar, but the accepted terminal types can be different.

Select options

Each option is described in this topic. Use a slash to select an option. Blank out the slash to deselect the option.

Command line at bottom

Specifies that the command line is to appear at the bottom of each logical screen. If you have specified that the panel should be displayed in CUA mode, the command line placement defaults to the bottom.

Note:

1. The default is to have the command line placement at the bottom. However, if your current application profile table specifies ASIS, the default does not override it.
2. If you deselect this field, the command line appears as specified in the panel definition statements. Unless indicated in the panel definition, it appears at the top of the panel.

When you select the Command line at bottom option, these changes take place:

- The command line moves to the last line of the logical screen or the line above the function keys depending on the CUA mode setting (see Table 1 on page 25).
- Each line that follows the command line shifts up one line.
- The long message overlays the line above the new command line location.

If the command line for a table display panel has been moved to the bottom and if no alternate placement has been specified for the long message line, the line directly above the repositioned command line is reserved (left blank) for the display of long messages. Otherwise, if you enter erroneous data on that line, a long message could overlay that data.

- In general, the display location of the function key definitions depends on several variables.
 - If the panel display mode CUA option is not selected, and the KEYLIST option is set to OFF, the function key definitions display on the lines immediately above the long message line.

- If the panel display mode CUA option is on, and the KEYLIST option is set to OFF, the function key definitions display below the long message line.
- If the KEYLIST option is set to ON, and the panel definition does not contain a)PANEL statement, the positioning of the function keys depends on the CUA mode setting.
- If the KEYLIST option is set to ON, and the panel definition contains a)PANEL statement, the positioning of the function keys is below the long message line.

If the Panel display CUA mode option is not selected, an exception to this situation occurs when an alternate placement for the long message line has been specified using the LMSG keyword on the)BODY header statement. Under these circumstances, the function key definitions display immediately above the command line.

If a conflict occurs between the placement of the function key definition lines and those that are to display long messages, short messages, and commands, the function keys will not overlay the command line, the line containing the long or short message field, or any line above one of these fields. Because of this condition, function key definition lines cannot appear at all on some screens.

When using the GDDM interface to display panels, the position of a graphics field does not change if the command line moves to the bottom of the screen.

In split-screen mode, if the top screen specifies the Command line at bottom option, the command line is moved to the line directly above the split line, and the long message line overlays the line above the command line. Because the placement setting is stored in the application profile pool, the setting for each logical screen is the same unless a user is running different applications in each screen.

Panel display CUA mode

Specifies that panels be displayed in CUA mode. This selection affects how the long message line, command line, and function keys are displayed, as described in Table 1.

The table summarizes how the command, long message, and function key area appear on the panel depending on whether you select the Panel display in CUA mode option. Note that the table uses the system default to position the long message field. An alternate long message field is not defined using the LMSG keyword on the)BODY header statement.

Table 1. CUA mode effect on panel display

Panel Characteristic	CUA mode selected	CUA mode not selected
Command line at bottom	Long message line Command line Fn=name	PF n=name Long message line Command line
Command line at bottom deselected	Title/short message Command line Long message line : Fn=name	Title/short message Command line Long message line : PF n=name

Table 2 on page 26 summarizes the effect of CUA mode on the top-row-displayed indicator.

Settings (option 0)

Table 2. CUA mode effect on top-row-displayed indicator

CUA Mode	Rows	Top-Row-Displayed Message	Message ID
YES	ALL	Row x to z of y	ISPZZ102
YES	SCAN	Row x From y	ISPZZ103
NO	ALL	Row x of y	ISPZZ100
NO	SCAN	Row x of y	ISPZZ100

Long message in pop-up

Specifies that long messages will be displayed in a pop-up window, regardless of the .WINDOW setting in the message source.

Tab to action bar choices

Specifies that you want to use the Tab key to move the cursor among the action bar choices.

Note: You cannot use the Tab key for this purpose if you are running in GUI mode.

Tab to point-and-shoot fields

Specifies that you want to use the Tab key to move the cursor through the point-and-shoot fields on a panel.

Note: You cannot use the Tab key for this purpose if you are running in GUI mode.

Restore TEST/TRACE options

When you select Dialog Test facility (option 7), certain TEST and TRACE options are established that can be different than those specified during ISPF start up. If you select Restore TEST/TRACE options, the TEST or TRACE values are restored to the ISPF call values when you exit dialog test. If you deselect the field, the TEST or TRACE values are not restored when you exit dialog test.

For more information about dialog test, see Chapter 9, "Dialog test (option 7)," on page 373.

Session Manager mode

Enter a slash to indicate that the Session Manager should handle any line mode output from the processing program.

Jump from leader dots

Enter a slash to enable the ISPF jump function from field prompts that have leader dots (. . or ...). Field prompts that have the ==> will always have the jump function enabled.

If the application developer defines the NOJUMP(ON) attribute keyword on a specific input field, this disables the "Jump from leader dots" and takes precedence over the selected Settings "Jump from leader dots" or the configuration table setting of "YES" for "Jump from leader dots".

Edit PRINTDS Command

Enter a slash to intercept the local print request to allow you to modify the statement before the PRINTDS command begins. For more information on editing the PRINTDS command, see the Libraries and Data Sets topic in *z/OS ISPF User's Guide Vol I*.

Always show split line

Specifies that the split line in split screen mode, as seen on a 3270 display,

should always be shown. The default for this option is that the option is selected. By deselecting this option, the split line does not display when the screen is split at the top or the bottom of the screen.

Enable EURO Sign

Enter a slash to enable the EURO sign (currency symbol). Your terminal or emulator must support the EURO sign for this option to work.

Scroll member list

Enter a slash to specify that ISPF should scroll to the first member selected in the member list after processing. If the Option field is deselected, automatic member list scrolling is disabled and the cursor is placed in front of the last member selected.

Allow empty member list

Specifies whether an empty member list will be displayed for a PDS that contains no members.

Allow empty member list (nomatch)

If the 'Allow empty member list' option is set, this field specifies whether an empty list that results from a nonmatching pattern will be displayed.

Empty member list for edit only

Specifies whether empty member list options apply to non-edit functions such as View and Browse.

Terminal characteristics

The Terminal Characteristics portion of the ISPF Settings panel allows you to specify values for the screen format and terminal type. Each of these characteristics is described here.

Screen format

Specification of screen format applies only to 327x and 3290 terminals (or a terminal emulator set to a mode that emulates a 327x or 3290 terminal). ISPF ignores screen format for other types of terminal.

Data Format is based on data width.
Std Format is always the primary screen size.
Max Format is always the alternate screen size.
Part Format uses hardware partitions (3279 only)

Note:

1. Primary and alternate screen dimensions are determined by the VTAM[®] logmode and the capabilities of the terminal or terminal emulator. These values can be displayed by the ISPF ENVIRON settings panel and issuing the QUERY request.
2. ISPF supports a minimum screen size of 24 rows and 80 columns. The maximum screen width is 160 columns.
3. If you are in an Edit session or you are using the Edit service, ISPF does not allow you to change the screen format.

Terminal type

Specify a valid terminal type. If you are using a terminal emulator, select the type of terminal that is being emulated (usually a 3278 or 3278x).

You can select one of the standard terminal types from the list on the ISPF Settings panel (see Figure 23 on page 23). If the selected terminal type seems to be incompatible with the current ISPF language setting, a 'Terminal Type Warning' Message will be displayed, but the terminal type will be accepted nevertheless.

Settings (option 0)

If you want to use a custom terminal translation table that has been created for your site, select OTHER to specify the name of the translation table. If the load of the new translation tables fails, ISPF reverts to the previous terminal type setting.

You can also select a terminal type by using the ISPTTDEF program, as described in *z/OS ISPF Dialog Developer's Guide and Reference*.

Specification of a terminal type allows ISPF to recognize valid (displayable) characters. Keep in mind that the terminal type value that you specify to ISPF might not be the actual terminal type. For example, if your terminal is a 3279, you specify 3278 because a 3279 terminal has the same character set as a 3278. The keyboard character sets for the specified terminal and the actual terminal are always compatible.

The terminal type designations in the text of this document are often the value to be specified to ISPF rather than the actual terminal type.

This panel can also include one or more installation-dependent options for terminal type, for example:

3277KN

3277 Katakana terminals

3278CF

3278 Canadian French terminals

3278KN

3278 Katakana terminals

A 5550-3270 Kanji emulation Version 3 terminal has the same character set as a 3278 Katakana terminal, so you should specify 3278KN as the terminal type. Also, because the 5550 running with the Japanese 3270PC/G Version 3 or 3270 PC Version 5 has the same character set as a 3278 Katakana terminal, in either case you should specify 3278KN as the terminal type.

The 5550 is run with the Japanese 3270PC V5 or 3270PC/G V3 emulation program. The terminal type, set by the ISPF Settings panel, is set to 3278KN.

Print graphics parms

The Print Graphics Params portion of the ISPF Settings panel allows you to specify to GDDM the family printer type, device name, and aspect ratio. These parameters are described here:

Family printer type

This parameter has a default value of 2, which cannot be changed.

Device name

VTAM node name of the physical printer to which graphic display output is to be routed. This name is supplied by your system programmer.

Aspect ratio

How the graphics aspect ratio (relationship to displayed screen image) is to appear on the printed output. Aspect ratio can be either of these:

- 0** Preserves the aspect ratio of the graphic area as displayed (Figure 24 on page 29). In other words, the ratio of the graphic area width to its height is the same on the printed document (Figure 25 on page 29) as in the displayed view. Zero is the default value. Figure 25 on page 29 shows how the graphic in Figure 24 on page 29 would appear if the PRINTG command were issued with an aspect ratio of 0.

- 1 Preserves the positional relationship between the graphic and the alphanumeric characters outside the graphics area. In other words, the printed graphic (Figure 26 on page 30) aligns horizontally with characters outside the graphics area the same as it (the printed graphic) aligns in the displayed image.

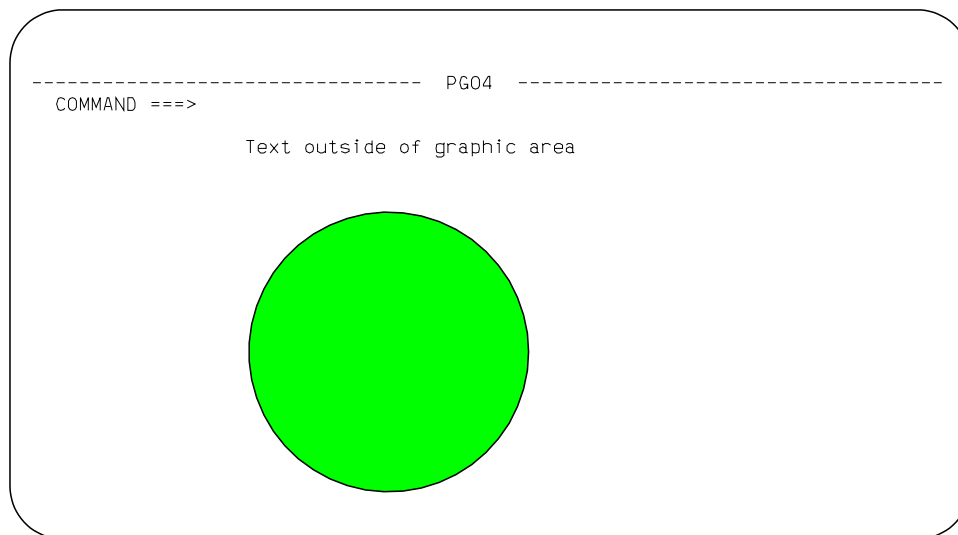

Figure 24. Screen containing graphics to be printed using *PRINTG*

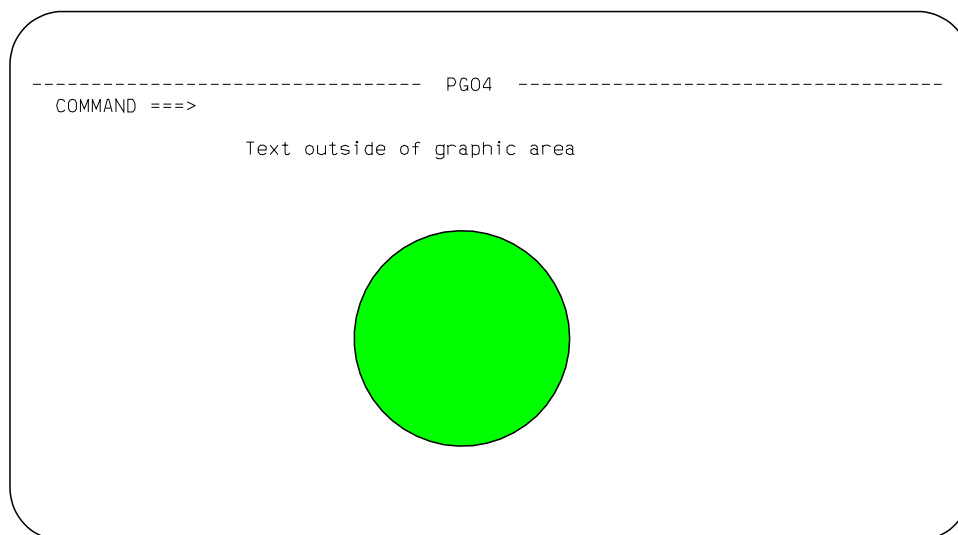

Figure 25. Example of using aspect ratio parameter 0

Figure 26 on page 30 shows how the graphic in Figure 24 would appear if the *PRINTG* command were issued with an aspect ratio of 1.

Settings (option 0)

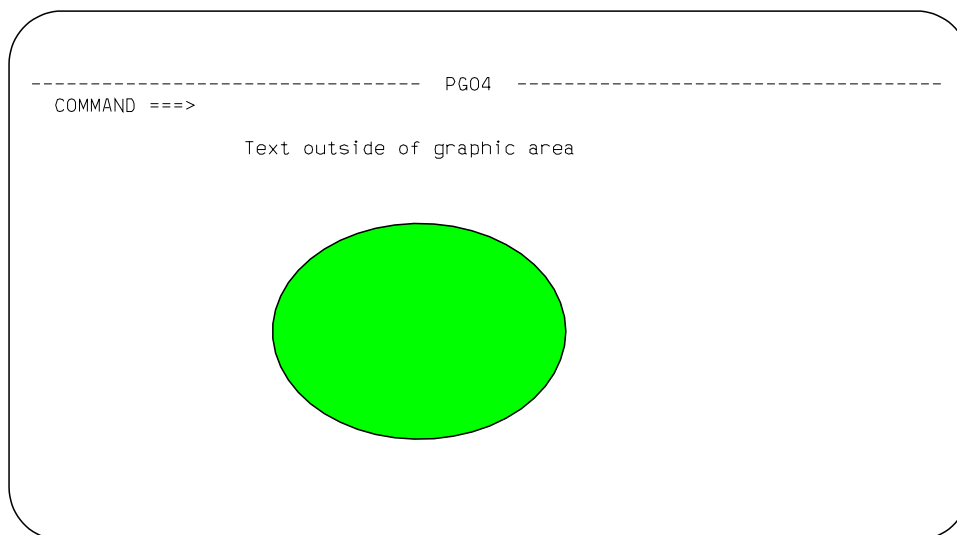

Figure 26. Example of using aspect ratio parameter 1

General

The General portion of the ISPF Settings panel allows you to specify values for the input field pad and command delimiter.

Input field pad

Specifies a pad character that controls the initial padding of blank (unfilled) panel input fields, including the selection panels, but not the data portion, of an Edit display. Within Edit, you control null or blank padding with Edit commands.

The pad character specified can be a B (blank), N (nulls), or any special (non-alphanumeric) character.

Note: When you are running in GUI mode, blank pad characters will be displayed as nulls in order to avoid the need to delete blank characters when replace mode is not available.

Command delimiter

You can stack commands on the command line by separating them with a delimiter. The default delimiter, the semicolon, can be changed using this option. Alphanumeric characters, the period (.), and the equal sign (=) are not valid command delimiters. Stacking allows you to enter, for example:

```
===> FIND DEPT;HEX ON
```

which finds the characters DEPT and then displays the file at that point in hexadecimal mode.

The system variable for the delimiter is ZDEL. For more information about ZDEL, refer to the *z/OS ISPF Dialog Developer's Guide and Reference*.

ISPF Settings panel action bar

The ISPF Settings panel action bar choices function as follows:

Log/List

The Log/List pull-down offers these choices:

- 1 **Log Data set defaults.** See "Log data set defaults" on page 32.

- 2 **List Data set defaults.** See “List data set defaults” on page 34.
- 3 **List Data set characteristics.** See “List data set characteristics” on page 35.
- 4 **JCL.** See “JCL” on page 37.

Function keys

The Function keys pull-down offers you these choices (see “Working with function keys and keylists (the Function Keys action bar choice)” on page 37 for more information):

- 1 **Non-Keylist PF Key settings.** Displays the PF Key Definitions and Labels panel.
- 2 **Keylist settings** Displays the Keylist Utility for ISP pop-up.
- 3 **Tailor function key display.** Displays the Tailor Function Key Definition Display panel.
- 4 **Show all function keys.** Changes the function key display. This will be an unavailable choice if you are currently showing all function keys.
- 5 **Show partial function keys.** Changes the function key display. This will be an unavailable choice if you are currently showing a partial list of function keys.
- 6 **Remove function key display.** Removes function keys from your screen. This will be an unavailable choice if you are currently not showing function keys.
- 7 **Use private and shared.** Equivalent to using the KEYLIST PRIVATE command.
- 8 **Use only shared.** Equivalent to using the KEYLIST SHARED command.
- 9 **Disable keylists.** Disables keylists. This choice is not available if you are currently running with keylists disabled.
- 10 **Enable keylists.** Enables keylists. This choice is not available if you are currently running with keylists enabled.

Colors The Colors pull-down offers you these choices (see “Changing default colors (the Colors action bar choice)” on page 51 for more information):

- 1 **Global colors** Displays the Global Color Change Utility panel.
- 2 **CUA Attributes** Displays the CUA Attribute Change Utility panel.
- 3 **Point-and-Shoot** Displays the CUA Attribute Change Utility panel, positioned on the Point-and-Shoot panel element.

Environ

The Environ pull-down offers you these choices (see “Specifying ISPF ENVIRON settings (the Environ action bar choice)” on page 57 for more information):

- 1 **Environ settings** Displays the ISPF ENVIRON Command Settings panel.

Workstation

The Workstation pull-down offers you these choices (see “Specifying workstation parameters (the Workstation action bar choice)” on page 59 for more information):

Settings (option 0)

- 1 **Workstation connection** Displays the Initiate GUI Session panel.
- 2 **GUI panel settings** Displays the GUI Settings panel.
- 3 **Workstation Tool Integration** Displays the tool integration panel.
- 4 **Download ISPF C/S Component** Displays the download panel.
- 5 **Disconnect from the Workstation** Disconnects from the workstation.

Identifier

The Identifier pull-down offers you these choices (see “Displaying message, system, user, panel, and screen IDs” on page 72 for more information):

- 1 **Message identifier** Displays the Message Identifier pop-up.
- 2 **Panel identifier** Displays the Panel Identifier pop-up.
- 3 **Screen Name** Displays the Screen Name pop-up.

Help The Help pull-down provides general information about the options available in the Settings panel and action bar.

Specifying log and list defaults and characteristics (the Log/List action bar choice)

The Log/List pull-down on the ISPF Settings panel action bar allows you to specify the log and list data set defaults that are used when you terminate ISPF by issuing the RETURN or END command or by entering an X on the ISPF Primary Option Menu.

The defaults can also be used when you issue the LOG or LIST command. You may specify the characteristics of the records to be contained in the list data set when it is defined.

Log data set defaults

When you select “Log Data set defaults” from the Log/List pull-down on the ISPF Settings panel action bar, the panel shown in Figure 27 on page 33 is displayed.

```

Log/List  Function keys  Colors  Environ  Workstation  Identifier  Help
-----
                ISPF Settings
                Log Data Set Defaults
                More:      +      +
0  Process option . . . . 1. Print data set and delete
                               2. Delete data set (without printing)
                               3. Keep data set (append subsequent
                               information to same data set)
                               4. Keep data set and allocate new data set

Batch SYSOUT class . . _____
Local printer ID or
writer-name . . . . . _____
Local SYSOUT class . . _____
Lines per page . . . . 60
Primary pages . . . . 10
Secondary pages . . . . 10
Log Message ID . . . . (/ = Yes)
F1=Help      F2=Split      F3=Exit      F7=Backward  F8=Forward
T  F9=Swap      F12=Cancel

Command ==> LOGDSD
F1=Help      F2=Split      F3=Exit      F7=Backward  F8=Forward  F9=Swap
F10=Actions  F12=Cancel

```

Figure 27. Log Data Set Defaults panel (ISPIFML1)

Local printer ID or writer name

Enter the name that your installation has assigned to an IBM 328x type of printer or the name of the external writer program. The default is blank. If you enter a name in this field, be sure to leave the Batch SYSOUT class field empty.

Lines per page

ISPF uses this value to determine when to cause a page eject if the eject control is not provided by the dialog; for example, when the dialog issues a LIST service request without the CC keyword specified.

Lines per page can range from 1 to 999. The initial default is 60. Normal values for lines per page are:

- 60 When printing 6 lines per inch
- 80 When printing 8 lines per inch.

Primary/Secondary pages

Primary/secondary allocation parameters are specified in terms of the anticipated number of pages of printout. These values are automatically converted by ISPF to the appropriate number of blocks before allocating space for the log data set. The initial default setting is 100 for both Primary pages and Secondary pages.

Specify a primary allocation of zero to prevent allocation and generation of the log.

If you modify the primary/secondary allocation parameters after the data set has been allocated, the new values take effect the next time you start ISPF. The log data set is allocated the first time you perform some action that results in a log message, such as saving edited data or submitting a batch job.

Log Message ID

If you select the Log Message ID option, the message ID is automatically added to the long message text written in the LOG data set.

Settings (option 0)

If you request default processing options for the log data set, these rules apply:

- If you specify Print data set and delete (1), you must also specify a Batch SYSOUT class and job statement information. If you specify Print data set and delete for both log and list, you can specify different Batch SYSOUT classes, but only one job is submitted for printing both data sets.
- If you specify routing to a local printer, you must specify a Local printer ID or writer name, and Batch SYSOUT must be blank. You can also enter a Local SYSOUT class if one is defined.

If you do not follow these rules or do not specify default processing options, primary option X or the RETURN command causes the final termination panel to be displayed.

List data set defaults

When you select “List Data set defaults” from the Log/List pull-down on the ISPF Settings panel action bar, the pop-up shown in Figure 28 is displayed.

```
Log/List  Function keys  Colors  Environ  Workstation  Identifier  Help
-----  -
ISPF Settings
List Data Set Defaults
0  Process option . . . . 1. Print data set and delete
                               2. Delete data set (without printing)
                               3. Keep data set (append subsequent
                               information to same data set)
                               4. Keep data set and allocate new data set
Batch SYSOUT class . . . . .
Local printer ID or
writer-name . . . . .
Local SYSOUT class . . . . .
Lines per page . . . . 60
Primary pages . . . . 100
Secondary pages . . . . 200
T  F1=Help      F2=Split     F3=Exit      F7=Backward  F8=Forward
    F9=Swap      F12=Cancel

Command ==> LISTDSD
F1=Help      F2=Split     F3=Exit      F7=Backward  F8=Forward  F9=Swap
F10=Actions  F12=Cancel
```

Figure 28. List Data Set Defaults panel (ISPISML2)

Local printer ID

Enter the name that your installation has assigned to an IBM 328x type of printer or the name of the external writer program. The default is blank. If you enter a name in this field, be sure to leave the Batch SYSOUT class field empty.

Lines per page

ISPF uses this value to determine when to cause a page eject if the eject control is not provided by the dialog; for example, when the dialog issues a LIST service request without the CC keyword specified.

Lines per page can range from 1 to 999. The initial default is 60. Normal values for lines per page are:

- 60 When printing 6 lines per inch
- 80 When printing 8 lines per inch.

Primary/Secondary pages

Primary/secondary allocation parameters are specified in terms of the anticipated number of pages of printout. These values are automatically converted by ISPF to the appropriate number of blocks before allocating space for the list data set. The initial default settings are 100 for Primary pages and 200 for Secondary pages.

If you modify the primary/secondary allocation parameters after the data set has been allocated, the new values take effect the next time you enter ISPF. The list data set is allocated the first time you request a print function or a dialog issues a LIST service request.

If you request default processing options for the list data set, these rules apply:

- If you specify Print data set and delete (1), you must also specify a Batch SYSOUT class and job statement information. If you specify Print data set and delete for both log and list, you can specify different Batch SYSOUT classes, but only one job is submitted for printing both data sets.
- If you specify routing to a local printer, you must specify a Local printer ID or writer name, and Batch SYSOUT must be blank.

If you do not follow these rules or do not specify default processing options, primary option X or the RETURN command causes the final termination panel to be displayed.

After reviewing or changing the parameters on this panel, enter the END command to return to the previous menu.

List data set characteristics

When you select “List Data set characteristics” from the Log/List pull-down on the ISPF Settings panel action bar, the panel shown in Figure 29 on page 36 is displayed to allow you to specify the characteristics of the records to be contained in the list data set when it is defined. You can specify the record format, the logical record length, and the line length to be printed. When the characteristics are reset, their new values take effect at once unless the list data set has already been allocated. In that case, the new values are used for the next list data set allocation. These values are saved in your user profile, which ISPF automatically builds and maintains across sessions.

Specifications for logical record length and line length values can affect truncation of lines written to the list data set by a LIST service request. See the description of the LIST service in *z/OS ISPF Services Guide* for more information.

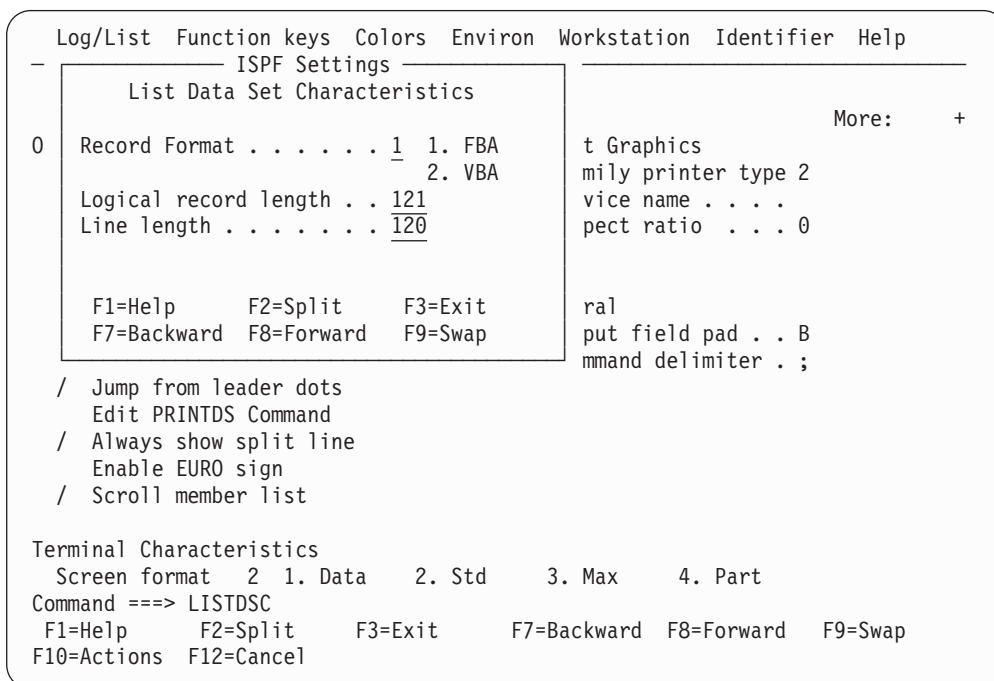

Figure 29. List Data Set Characteristics panel (ISPISML3)

The fields on this panel are described here:

Record Format

The record format specifies the format and characteristics of the records in the list data set. The allowable record formats are:

- FBA** Fixed-length records that contain ANSI-defined printer control characters
- VBA** Variable-length records that contain ANSI-defined printer control characters.

The default setting is FBA.

Logical Record Length

The logical record length specifies the length, in bytes, of fixed-length records or the maximum length allowed for variable-length records. The default value is 121. This value represents one ANSI-defined control character and 120 bytes of data to be printed.

Line Length

The line length specifies the length of the logical line to be printed. If the specified line length is greater than the logical record length of the list data set, data is truncated. The range of allowable lengths is from 80 bytes to 160 bytes. The default value is 120.

The information supplied by the parameters allows for the printing of panels whose line lengths would not otherwise be supported by the available printing facilities.

For example:

- If a panel to be printed is 160 bytes wide but printing capabilities allow only 132 bytes, you should specify:

```

RECFM
      FBA or VBA
Line Length
      130
            
```

LRECL

132 (allows for two ANSI-defined control characters).

The first page of output would contain the first 130 bytes of the panel. The second page would contain the last 30 bytes. This technique is referred to as the *cut and paste* method of printing.

- If a panel to be printed is 132 bytes wide and the printer supports this line length, you should specify:

RECFM

FBA or VBA

Line Length

132

LRECL

133 (allows for one ANSI-defined control character).

The entire panel would be printed on one page of output.

- If a panel to be printed is 80 bytes wide, ISPF uses the default values for the LIST parameters. The entire panel would be printed on one page of output.

JCL

When you select JCL from the Log/List pull-down on the ISPF Settings panel action bar, the pop-up shown in Figure 30 is displayed. You can specify up to four default job statements to be used when printing a log or list data set.

```

Log/List  Function keys  Colors  Environ  Workstation  Identifier  Help
          ISPF Settings
          Log and List JCL

Job statement information:      (Required for system printer)
_____  

_____  

_____  

_____

F1=Help   F2=Split   F3=Exit   F9=Swap   F12=Cancel

Session Manager mode           Command delimiter . ;
:

```

Figure 30. Log and List JCL panel (ISPISMLJ)

Working with function keys and keylists (the Function Keys action bar choice)

The Function keys pull-down on the ISPF Settings panel action bar (see Figure 31 on page 39) allows you to define function keys and to create, edit, delete, and view keylists.

Nearly all panels in ISPF have associated keylists, although specific keylists typically serve numerous panels. There are several keylists used in the ISPF product panels. These keylists all start with the characters ISR. In addition, ISPF contains some keylists that start with the characters ISP. They are not used in any ISPF product panels, but can be used by an application if needed. Keylists are used when an application panel contains a)PANEL statement.

Settings (option 0)

To accommodate both users who require CUA-compliant keylists and those who prefer to use the traditional ISPF function key assignments, F1-F12 are assigned CUA-compliant values, and F13-F24 are assigned traditional ISPF values. Therefore, the user who runs in default mode (ZPRIKEYS set to UPP; also see “Tailor function key definition display” on page 48) can retain the traditional key settings.

Note: Function keys in Edit are documented in *z/OS ISPF Edit and Edit Macros*. They are not CUA-compliant.

The KEYS and KEYLIST commands have been modified to benefit the user as well. When KEYS is issued from a panel that is not using a keylist, the PF Key Definitions and Labels panel is displayed, which allows you to change the ZPF variable settings, as in previous versions of ISPF. However, if the keys command is issued from a panel with an *active* keylist, the associated Keylist Utility panel Change panel is displayed.

The user can also control the use of keylists associated with panels using the KEYLIST command. Specifying KEYLIST OFF causes ISPF to ignore the keylist in all logical screens running under the application ID from which the KEYLIST OFF command was issued, and to use the ZPF variables for controlling function keys. The KEYLIST ON command (the default) causes ISPF to recognize the preeminence of keylists again. KEYLIST ON and OFF are equivalent to the Enable and Disable keylist choices on the Function keys pull-downs discussed in “Keylist settings” on page 42.

ISPF default keylist

ISPKYLST is the ISPF default keylist. If you do not specify a keylist to be associated with a panel using the KEYLIST attribute on the PANEL tag (DTL) or using the)PANEL statement, ISPF uses the keys defined for ISPKYLST to display in the function area of the panel when it is displayed. The key settings and forms for ISPKYLST are as shown in Table 3.

Table 3. ISPKYLST key settings

Key	Command	Form
F1	HELP	Short
F2	SPLIT	Long
F3	EXIT	Short
F9	SWAP	Long
F12	CANCEL	Short
F13	HELP	Short
F14	SPLIT	Long
F15	EXIT	Short
F21	SWAP	Long
F24	CANCEL	Short

ISPF default keylist for help panels

You can specify a keylist to be associated with a help panel by using the keylist attribute on the HELP tag (DTL) or by using a)PANEL statement in your panel definition. If you do not specify a keylist, ISPF uses the keys defined for ISPHELP to display in the function area of the help panel when it is displayed. The key settings and forms for ISPHELP are shown in Table 4 on page 39.

Table 4. ISPHELP key settings

Key	Command	Form
F1	HELP	Short
F2	SPLIT	Long
F3	EXIT	Short
F5	EXHELP	Short
F6	KEYSHELP	Short
F7	UP	Long
F8	DOWN	Long
F9	SWAP	Long
F10	LEFT	Long
F11	RIGHT	Long
F12	CANCEL	Short

Figure 31 shows the Function keys pull-down on the ISPF Settings panel action bar. Each pull-down choice is described following the panel.

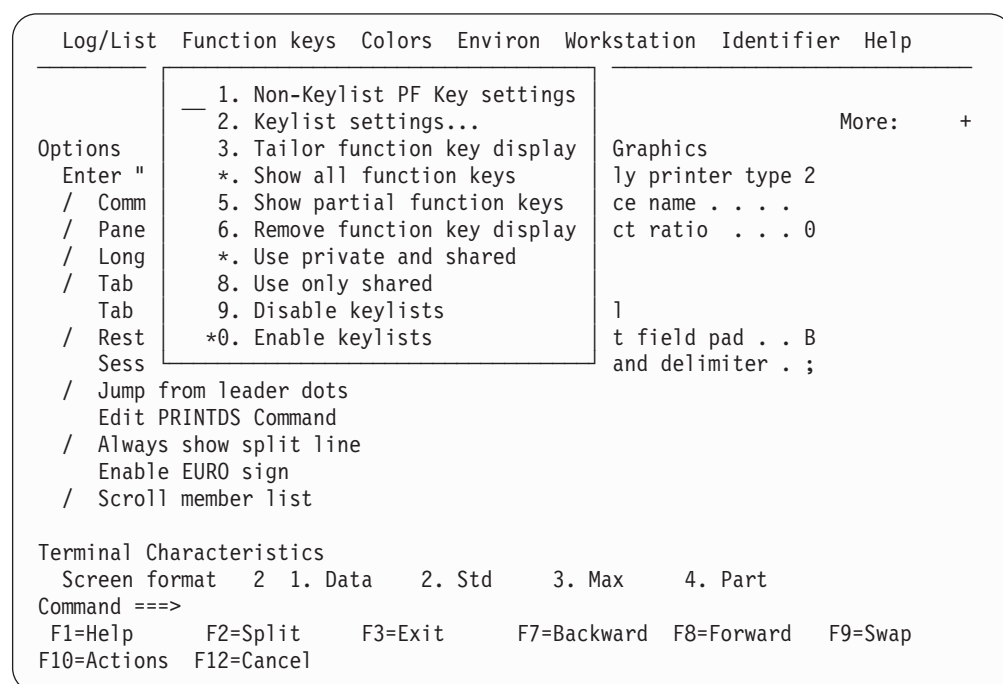

Figure 31. Function keys pull-down on the ISPF settings panel action bar (ISPISMMN)

Non-keylist PF key settings

When you select Non-Keylist PF key settings from the Function keys pull-down on the ISPF Settings panel action bar, the PF Key Definitions and Labels panel shown in Figure 32 on page 40 is displayed. If you enter the KEYS command on the command line of any panel, the system displays one of two panels:

- If you are not using keylists (that is, keylists are disabled) or if there is no keylist associated with the panel from which you enter the KEYS command, the PF Key Definitions and Labels panel shown in Figure 32 on page 40 is displayed.
- If you are using keylists (that is, keylists are enabled) and there is a keylist associated with the panel from which you enter the KEYS command, the Keylist Change panel shown in Figure 37 on page 46 is displayed.

Settings (option 0)

If you define your application panels using panel definition statements, use the PF Key Definitions and Labels - Primary Keys panel to assign function keys and associated labels to ISPF commands.

Note: See “Keylist settings” on page 42 to find out how to assign function keys that are associated with a keylist.

```

                                PF Key Definitions and Labels
                                More:      +
Number of PF Keys . . . 12           Terminal type . : 3278

PF1 . . . HELP
PF2 . . . SPLIT
PF3 . . . END
PF4 . . . RETURN
PF5 . . . RFIND
PF6 . . . RCHANGE
PF7 . . . UP
PF8 . . . DOWN
PF9 . . . SWAP
PF10 . . LEFT
PF11 . . RIGHT
PF12 . . RETRIEVE

PF1 label . . _____ PF2 label . . _____ PF3 label . . _____
PF4 label . . _____ PF5 label . . _____ PF6 label . . _____
PF7 label . . _____ PF8 label . . _____ PF9 label . . _____
PF10 label . . _____ PF11 label . . _____ PF12 label . . _____

Press ENTER key to display alternate keys. Enter END command to exit.
Command ==>>
  F1=Help   F2=Split   F3=Exit   F7=Backward F8=Forward F9=Swap
  F12=Cancel
```

Figure 32. PF Key Definitions and Labels panel (ISPOPT3D)

Note: The panel in Figure 32 is displayed for terminals with 12 function keys. For terminals with 24 function keys, the first panel displayed shows the *primary* keys (F1-F12). When you press the Enter key, ISPF displays a panel showing the *alternate* keys (F13-F24). To alternate between the two panels, press the Enter key.

You can assign function keys to system commands, such as HELP or END, to commands that are meaningful within a particular function or environment, such as the Edit FIND and CHANGE commands, and to line commands, such as the Edit or dialog test I or D commands.

Before changing function key assignments, verify the terminal type selected on the ISPF Settings panel and the number of function keys (12 or 24). For a list of valid terminal types refer to Figure 23 on page 23.

You can define or change a function key function simply by equating the key to a command. For example:

```
PF9 . . . CHANGE ALL ABC XYZ
PF12 . . PRINT
```

In the example, F9 has been equated to an Edit command, and F12 has been equated to the system-defined PRINT command.

If you enter a blank for any function key definition, the key is restored to its ISPF default.

A function key definition beginning with a colon (:) is treated as a special case. The colon is stripped off, and the command to which the key is equated is inserted in the first input field on the line at which the cursor is currently positioned.

A function key definition beginning with a greater-than sign (>) is another special case. It causes the command to be passed to the dialog, regardless of whether the command appears in the command tables. When an ISPF function is executing, do not press the RESET key and then attempt to enter information or use a function key, because the results are unpredictable.

The label fields shown in Figure 32 on page 40 allow you to specify user-defined labels for the displayed representations of function key definitions. This provides for displaying meaningful words of eight characters or fewer, rather than the first eight, possibly meaningless, characters of a lengthy function key definition.

If a label is not assigned, the definitions displayed for that function key consist of the first eight characters of the function key definition.

If the label value is BLANK, the function key number and the equal sign display, but the value portion of that function key definition displays as actual blanks. This label might be used if, for example, a function key is not defined or if it is meaningless to the user, but the dialog developer wants each function key number to appear sequentially in the function key definition lines.

No function key information, not even the number, appears if the label value for that key is NOSHOW.

Figure 33 on page 42 shows how the function key panel can be used to assign definitions and labels. In this example, F4 has been equated to a TSO data management command, while F12 has been equated to a command that requests job submission. Labels for several function keys are defined as well.

Settings (option 0)

```

                                PF Key Definitions and Labels
                                More:      +
Number of PF Keys . . . 24                Terminal type . : 3278

PF1 . . . HELP
PF2 . . . SPLIT
PF3 . . . END
PF4 . . . TSO LISTALC ST
PF5 . . . RFIND
PF6 . . . RCHANGE
PF7 . . . UP
PF8 . . . DOWN
PF9 . . . SWAP
PF10 . . LEFT
PF11 . . RIGHT
PF12 . . TSO SUBMIT NOTIFY

PF1 label . . _____ PF2 label . . BLANK      PF3 label . . _____
PF4 label . . DATASETS    PF5 label . . FIND      PF6 label . . CHANGE
PF7 label . . NOSHOW      PF8 label . . NOSHOW    PF9 label . . _____
PF10 label . . _____ PF11 label . . _____ PF12 label . . SUBMIT

Press ENTER key to display alternate keys. Enter END command to exit.
Command ==>
  F1=Help   F2=Split   F3=Exit   F7=Backward F8=Forward F9=Swap
  F12=Cancel
```

Figure 33. Using the PF Key Definitions and Labels panel (ISPOPT3E)

This figure shows the function key settings that are displayed on a panel when defined using the key definitions and labels in Figure 33.

```

----- EMPLOYEE SERIAL ----- DUPLICATE NUMBER
COMMAND ==>

ENTER EMPLOYEE SERIAL BELOW:

      EMPLOYEE SERIAL ==> 598304      (MUST BE 6 NUMERIC DIGITS)

PRESS ENTER TO DISPLAY NEXT SCREEN FOR ENTRY OF EMPLOYEE DATA.
PRESS END KEY (PF3) TO END THIS SESSION.

F1=HELP    F2=      F3=END    F4=DATASETS  F5=FIND    F6=CHANGE
F9=SWAP    F10=LEFT  F11=RIGHT F12=SUBMIT
```

Figure 34. Example screen with function key definition lines

Keylist settings

To create or change a keylist associated with your panels, or to refer to or delete a keylist help panel from your keylist, select the “Keylist settings” choice from the Function keys pull-down on the ISPF Settings panel action bar, or enter the

KEYLIST command. The first panel displayed is similar to Figure 35. If you Enter the KEYS command from a panel that uses a keylist, the keylist change panel for the keylist active on the original panel is displayed.

```

-   File View   Keylist Utility   -
-   -----   -----
0   Keylist Utility for ISR   Row 1 to 11 of 16   +
    Actions:  N=New E=Edit V=View D=Delete /=None
    Keylist  Type
    -   ISRHELP  SHARED
    -   ISRHLP2  SHARED
    -   ISRNAB   SHARED
    -   ISRNSAB  SHARED
    -   ISRREFL  SHARED
    -   ISRREFO  SHARED
    -   ISRSAB   SHARED   *** Currently active keylist ***
    -   ISRSCRVT SHARED
    -   ISRSLAPP SHARED
    -   ISRSNAB  SHARED
    T   -   ISRSPBC  SHARED
    Command ==>>>   Scroll ==>> PAGE
    C   F1=Help   F2=Split   F3=Exit   F7=Backward   F8=Forward
        F9=Swap   F10=Actions  F12=Cancel
    F

```

Figure 35. Keylist Utility panel (ISPKLUP)

In Figure 35, ISPHelp, ISPHLP2, ISPNAB, ISPSAB, ISPSNAB, ISPTST, ISRHELP, ISRNAB, and ISRNSAB have already been created for application ISR. ISPSAB, the currently active keylist, and ISPSNAB are keylists for the keylist utility panels. ISPKYLST is the ISPF default keylist for any DTL application panel or any panel defined with a)PANEL section that does not have a keylist defined. ISPHelp is the ISPF keylist for help panels created using DTL or using a)PANEL section.

The application ID is shown on the title line of the panel (ISR in Figure 35) and defaults to the application ID of the keys table in which the keylist was found when the KEYLIST command was entered. You can specify the keylist application ID on the)PANEL statement, or, if using DTL, it can be specified when you call the ISPF conversion utility using the KEYLAPPL option on the ISPD TLC command. If the panel does not specify an application ID, ISPF searches the currently executing application's keys table for a keylist that has the same name as the name specified on the PANEL tag. If the keylist is not found, and the current application ID is not ISP, ISPF searches the ISP application.

The column marked Type indicates whether a keylist is shared or is a private copy. For information about the KEYLIST SHARED and KEYLIST PRIVATE system commands, see the topic about Using Commands, Function Keys, and Light Pen or Cursor Selection in the *z/OS ISPF User's Guide Vol 1*. Shared keylists are created by the ISPF DTL Conversion Utility. They cannot be deleted by the keylist utility. If a shared keylist is modified by the keylist utility, it is saved as a private keylist copy in a table named xxxxPROF, where xxxx is the application ID. The keylist utility now shows the keylist as a private copy. If you have issued the KEYLIST SHARED command, you can still modify a keylist, but you cannot see the changes reflected in the function keys until the KEYLIST PRIVATE command is issued.

Settings (option 0)

Note: The keylist utility is meant for users to modify function keys for their own use. To define function keys for all users of an application or for site-wide use, the definitions in the Dialog Tag Language should be modified and a new xxxxKEYS table should be generated.

The Keylist Utility panel action bar choices function as follows:

File Allows you to create a new keylist, to edit, view, or delete existing keylists, or to exit the keylist utility.

View Enables you to display another set of keylists. These options are described in "View pull-down" on page 48.

File pull-down: To create, edit, view, or delete a keylist, use either of these methods:

- Use a slash in the Select column to select a keylist from those displayed, then select the appropriate choice from the File pull-down.
- Select a keylist from those displayed using one of these actions: N(New), E(Edit), V(View), or D(Delete). If you use N(New), you are prompted for the name of the keylist you are about to create.

The choices on the File pull-down function as follows:

New To create a keylist, enter the keylist name when prompted. You are prompted after selecting New from the File pull-down, or after typing N next to any displayed keylist and pressing Enter. The screen shown in Figure 36 is displayed.

The screenshot shows the 'Keylist Utility' panel with the 'File' pull-down menu open. The menu options are: File, Defaults, ISR Keylist SAMPLE1 Create, and Row 1 to 9 of 24. Below the menu, there is a prompt: 'Make changes and then select File action bar choice.' and 'Keylist Help Panel Name . . . _____'. A table for defining function keys is shown with columns for Key, Definition, Format, and Label. The keys F1 through F9 are listed, each with a blank line for the definition and blank lines for format and label. At the bottom, there is a command bar with the following options: F1=Help, F2=Split, F3=Exit, F7=Backward, F8=Forward, F9=Swap, F10=Actions, and F12=Cancel. The command bar also includes 'Command ==>' and 'Scroll ==> PAGE'.

Figure 36. Keylist Create panel (ISPKLUCR)

The Keylist Create panel action bar choices function as follows:

File The File pull-down offers these choices:

- 1 **Cancel.** Cancels the creation of this keylist and returns to the Keylist Utility panel.

- 2 **Save and Exit.** Saves the keylist and returns to the Keylist Utility panel.

Defaults

The Defaults pull-down offers you the choice of the five default function key settings described in Table 5.

Table 5. Default key settings

Condition	Function key settings
No defaults	No values are filled in.
Non-scrollable, no action bar	F1 HELP F2 SPLIT F3 EXIT F9 SWAP F12 CANCEL
Scrollable, no action bar	F1 HELP F2 SPLIT F3 EXIT F7 BACKWARD F8 FORWARD F9 SWAP F12 CANCEL
Non-scrollable, with action bar	F1 HELP F2 SPLIT F3 EXIT F9 SWAP F10 ACTIONS F12 CANCEL
Scrollable, with action bar	F1 HELP F2 SPLIT F3 EXIT F7 BACKWARD F8 FORWARD F9 SWAP F10 ACTIONS F12 CANCEL

If you are creating a keylist on a terminal defined to have 24 keys, the 13-24 keys are set the same as the 1-12 keys. For example, F13 is automatically set the same as F1. HELP, EXIT, ACTIONS, and CANCEL all have display format SHORT. SPLIT, UP, DOWN, and SWAP have display format LONG.

Edit To edit the key definitions, display formats, and labels for a keylist, enter the keylist name when prompted. Select a keylist with a slash and select Edit from the File pull-down, or type E next to a keylist name and press Enter. The screen shown in Figure 37 on page 46 is displayed, showing the existing values.

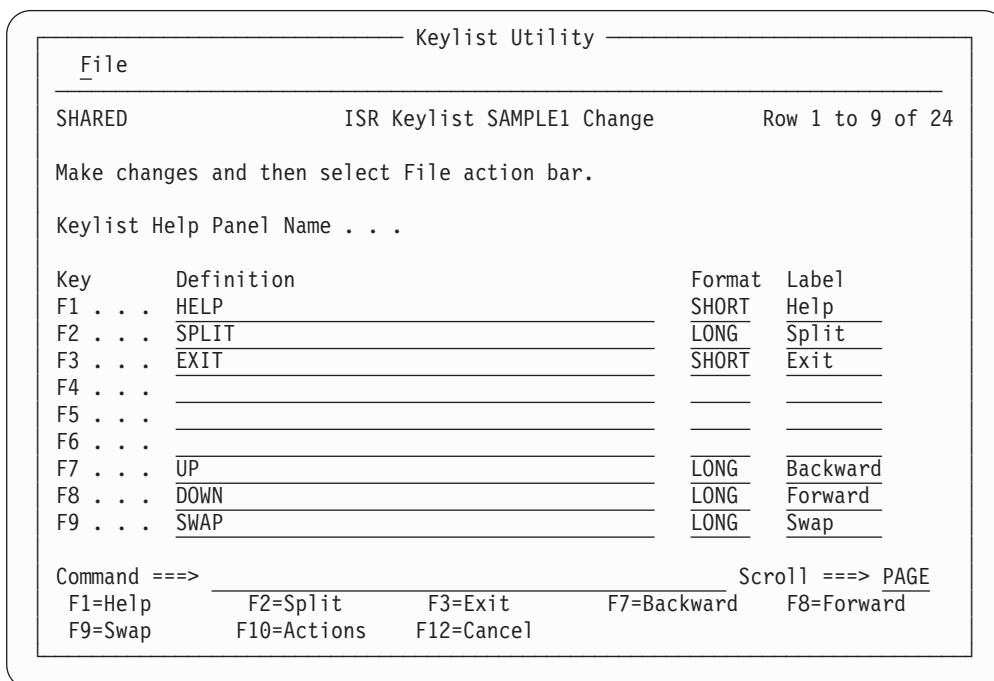

Figure 37. Keylist Change panel (ISPKLUCH)

The Keylist Change panel action bar choice functions as follows:

- File** The File pull-down offers these choices:
- 1 **Cancel.** Cancels the changes to this keylist and returns to the Keylist Utility panel.
 - 2 **Save and Exit.** Saves the changes to this keylist and returns to the Keylist Utility panel or the panel from which you issued the KEYS command.

These fields appear on the Keylist Utility Change panel:

Row x to x of xx

Indicates that you must scroll the panel to access the remaining label definitions.

Keylist Help Panel Name

To refer to a help panel from this keylist, enter the help panel name in this field in this format:

- Must be 1-8 characters
- First, or only, character must be A-Z or a-z
- Remaining characters, if any, must be A-Z, a-z, 0-9

To remove a help panel name from a keylist, replace the help panel name with blanks.

Definition

If a display format or a label is specified, a definition must also be specified. Any definition is valid.

Format

The only valid display formats are:

LONG

The default. Indicates that the key label should be displayed in the function key area when the FKA command is toggled to the first cycle after OFF.

SHORT

Indicates that the key label should be displayed in the function key area when the FKA command is toggled to the first or second cycle after OFF. A key will display more often in the function key area if it is given the SHORT display format.

NO

Indicates that the key label should never be displayed in the function key area, regardless of the FKA command toggle cycle.

Label Any label is valid. If the Label field is left blank, it will default to the definition. This will happen only if the field is blank. If the Label field is not blank and the definition is changed, the Label field will not change automatically.

View To view a keylist, but not modify it, enter the keylist name when prompted. Select the keylist with a slash, then select View from the File pull-down, or type V next to the keylist name displayed and press Enter. The screen shown in Figure 38 is displayed.

```

Keylist Utility
-----
SHARED          ISR Keylist SAMPLE1 View          Row 1 to 11 of 24

The definition of the SAMPLE1 keylist is below.

Keylist Help Panel Name . . : ISPSAB

Key      Definition                                Format  Label
F1 . . . HELP                                     SHORT  Help
F2 . . . SPLIT                                    LONG   Split
F3 . . . EXIT                                     SHORT  Exit
F4 . . .
F5 . . .
F6 . . .
F7 . . . UP                                       LONG   Backward
F8 . . . DOWN                                    LONG   Forward
F9 . . . SWAP                                    LONG   Swap
F10 . .
F11 . .

Command ==>>                                     Scroll ==>> PAGE
F1=Help      F2=Split    F3=Exit      F7=Backward  F8=Forward
F9=Swap      F12=Cancel

```

Figure 38. Keylist utility view panel (ISPCLUB)

If you select View, the help panel name, key definitions, display formats, and labels are displayed but cannot be changed.

Delete To delete a private copy of a keylist, enter the keylist name when prompted. Select the keylist with a slash, then select Delete from the File pull-down, or type D next to the keylist name displayed and press Enter. The Delete Keylist Confirmation pop-up shown in Figure 39 on page 48 is displayed.

Note: Shared keylists can only be deleted using the Dialog Tag Language.

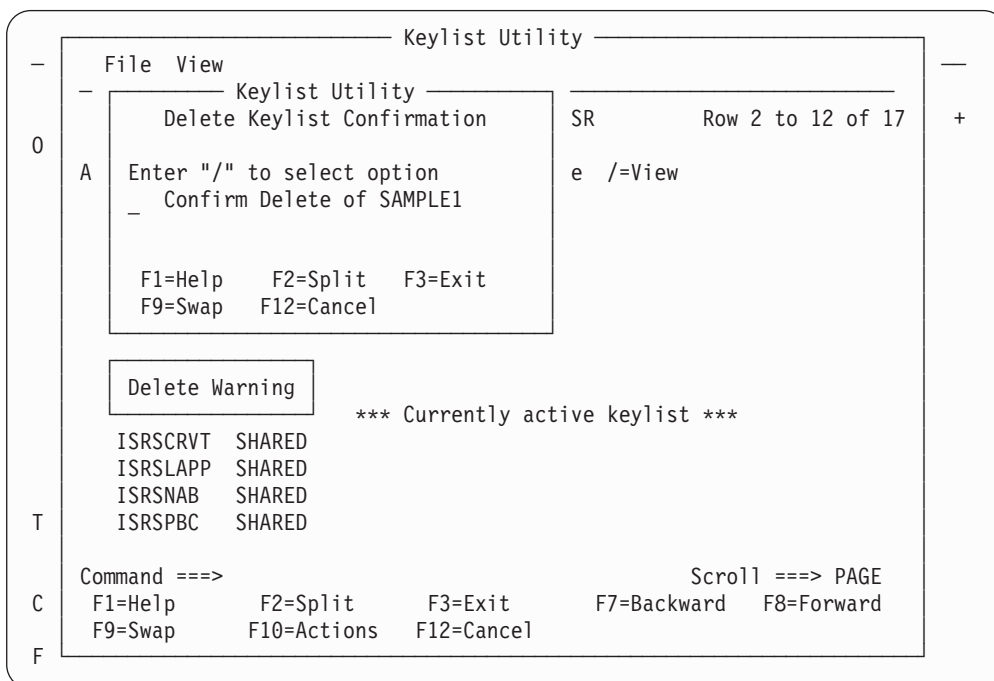

Figure 39. Keylist utility with delete keylist confirmation pop-up (ISPKLUP)

Use caution when deleting a keylist from an application that is currently running. If you delete a keylist that is required by a panel in the application, an error message appears and the panel does not display.

Exit Select Exit from the File pull-down to exit the keylist utility.

View pull-down: To display another set of keys on the Keylist Utility panel, select View on the action bar.

The View pull-down choices function as follows:

By current panel keylist

Displays the list of keys related to the current panel.

By current dialog keylist

Displays the list of keys related to the dialog that is currently running.

Specify a keylist application ID

Displays the list of keys for another application.

Tailor function key definition display

The Tailor Function Key Definition Display panel (shown in Figure 40 on page 49) allows you to change the format of the function key definition lines that are displayed at the bottom of the screen. To display this panel, perform one of these actions:

- Select the “Tailor function key display” choice from the Function keys pull-down.
- Issue the PFSHOW TAILOR command from any command line.

```

-      ISPF Settings
  Tailor Function Key Definition Display

For all terminals:
0  Number of keys . . 2  1. 12
                               2. 24

    Keys per line . . . 1  1. Six
                               2. Maximum possible

    Primary range . . . 1  1. Lower - 1 to 12
                               2. Upper - 13 to 24

For terminals with 24 PF keys:
    Display set . . . . 1  1. Primary - display keys 1 to 12
                               2. Alternate - display keys 13 to 24
                               3. All - display all keys

T  Press ENTER key to save changes.  Enter END to save changes and exit.

Command ==>
C  F1=Help      F2=Split      F3=Exit      F7=Backward  F8=Forward
   F9=Swap      F12=Cancel
F

```

Figure 40. Tailor Function Key Definition Display panel (ISPOPFA)

From the Tailor Function Key Definition Display panel you can set these function key parameters:

Number of keys

The number of function keys you specify controls the particular set of function key definitions currently in use.

ISPF automatically determines the terminal type, screen size, and number of function keys:

- If the screen size is greater than 24 lines, but the terminal type specified implies a maximum of 24 screen lines, ISPF sets the terminal type to 3278.
- If you press a function key higher than 12, but the value specified for the number of function keys on your terminal is 12, ISPF sets the terminal type to 3278 and the number of function keys to 24.

ISPF cannot determine the terminal type or number of function keys in these cases:

- If you switched between a 3277 and 3278 Model 2, both of which are 24-line terminals
- If you switched from a terminal with 24 function keys to a terminal with 12 function keys.

In these cases, you must inform ISPF of the terminal type and number of function keys you are using. Otherwise, ISPF uses an incorrect character set and invalid function key definitions.

ISPF automatically sets, or changes, the number of function keys in these cases:

- If you specify 3277, ISPF initializes the number of keys to 12.
- If you specify 3278, ISPF initializes the number of keys to whatever was stored from the user's last ISPF session. If no number is stored from a prior session, the number of keys is initialized to 12.

Settings (option 0)

- If you press a function key higher than 12, ISPF sets the number of keys to 24. ISPF cannot set the number of keys to 24 for the 3278T terminal.

Keys per line

You can specify the number of keys per line to be displayed on the function key definition lines. Six or Maximum possible can be specified, indicating either six keys or the maximum possible keys. Six ensures consistency across all panels. Maximum possible can save space on crowded panels. The Maximum possible option is forced when you select the Panel display CUA mode option on the ISPF Settings panel.

Primary range

You can specify that the primary key range be:

Lower Primary keys are F1-F12.

Upper Primary Keys are F13-F24.

The default value is lower.

Display set

For terminals with 24 function keys, you can choose to display only the primary set of function keys (F1-F12, the default range), the alternate set of function keys (F13-24), or all 24 keys. Your display choices depend on which range you specify for the Primary range option. For terminals with 12 function keys, this setting is ignored.

The Function keys pull-down

The Function keys pull-down provides choices that enable you to display the function keys in various forms.

Choices for changing PF key definitions

You can change the PF Keys that you have defined by using one of the first three choices on the Function Keys pull-down. Choosing “Non-keylist PF Key settings” calls the PF Key Definitions and Labels panel, where you can assign PF keys to ISPF commands, and label them. This choice is like using the KEYS command.

Choosing “Keylist settings” from the pull-down is like using the KEYLIST command, and the “Tailor Function Key Display” choice calls up the Tailor Function Key Definition Display panel.

Choices for showing PF keys on the display screen

By selecting “Show all function keys”, “Show partial function keys”, or “Remove function key display”, you can specify that ISPF use the long form of function key display, the short form of function key display, or no function keys, respectively.

Each of these pull-down choices has an equivalent PFSHOW and FKA command associated with it. The commands operate as toggles; the pull-down choices become unavailable if they are the current setting.

This table explains the relationship between the pull-down choices and their related command combinations.

Table 6. Displaying forms of the function keys

Pull-down Choice	Command Equivalent	Result
Show all function keys	PFSHOW PFSHOW ON FKA FKA ON	Long setting; all available function keys displayed. This is the default setting.

Table 6. Displaying forms of the function keys (continued)

Pull-down Choice	Command Equivalent	Result
Show partial function keys	PFSHOW (second time issued) FKA (second time issued) FKA SHORT*	Short setting; a partial listing of the function keys displayed.
Remove function key display	PFSHOW (third time issued) PFSHOW OFF FKA (third time issued) FKA OFF	No function keys displayed. If PFSHOW or FKA is issued for a fourth time, the display returns to the long, or ON, setting.
Note: * The FKA SHORT command can be issued at any time to invoke the short setting.		

Choices for determining who can use your PF keylist

The Function keys pull-down has two choices that are equivalent to the KEYLIST PRIVATE and KEYLIST SHARED commands:

Use private and shared

Causes ISPF to use the keylist defined as private (equivalent to the KEYLIST PRIVATE command). Private is the default. It is unavailable if it is the current setting.

Use only shared

Causes ISPF to use the keylist defined as shared (equivalent to KEYLIST SHARED). It is unavailable if it is the current setting.

Choices for enabling keylists

The Function keys pull-down has two choices that are equivalent to the KEYLIST ON and KEYLIST OFF commands:

Enable keylists

Causes ISPF to use the keylist defined with the panel (equivalent to the KEYLIST ON command). Enable keylists is the default. It is unavailable if it is the current setting.

Disable keylists

Causes ISPF to ignore the keylist defined with the panel (equivalent to KEYLIST OFF). It is unavailable if it is the current setting.

Changing default colors (the Colors action bar choice)

The Colors pull-down on the ISPF Settings action bar provides access to the Global Color Change Utility, the ISPF CUA Attribute Change Utility, and the Point-and-shoot Color Change panel. In GUI mode, the choice starts the Global GUI Color Change Utility.

Global colors

For ISPF-supported seven-color terminals, ISPF provides the Global Color Change Utility (on the host) and the Global GUI Color Change Utility (on the workstation) to allow you to globally change the current colors ISPF uses for display.

To invoke the utility appropriate for your environment, perform one of these actions:

- Select the Global colors... choice from the Colors pull-down.
- Issue the ISPF system command COLOR from any ISPF command line.

Settings (option 0)

ISPF displays the Global Color Change Utility panel shown in Figure 41 if you are running in host mode; it displays the Global GUI Color Change Utility panel shown in Figure 42 on page 53 if you are running in GUI mode.

Global color change utility: From the panel shown in Figure 41, you can change the ISPF-defined default colors.

```

-      ISPF Settings
  Global Color Change Utility
  Help
  More:  +
0  Globally change one or more of the ISPF default colors and
   press ENTER to immediately see the effect. Clearing a color
   field and pressing ENTER restores the default color or
   selecting the Defaults point-and-shoot field restores all
   default colors.
   Enter the EXIT command to save changes or enter the CANCEL
   command to exit without saving.
   ISPF Default Color
   Blue . . . . . _____
   Red . . . . . _____
   Pink . . . . . _____
   Green . . . . . _____
   Turquoise . . _____
   T Yellow . . . _____
   White . . . . . _____
   Command ==> _____ Defaults
   C F1=Help      F2=Split      F3=Exit      F7=Backward
   F8=Forward    F9=Swap      F12=Cancel
   F
   9=Swap

```

Figure 41. Global Color Change Utility panel (ISPOPT10)

Enter a new value in the color field beside the ISPF-defined default color to be changed. The valid color choices are RED, PINK, GREEN, YELLOW, BLUE, TURQ, and WHITE.

Color changes are reflected on the panel display immediately after you press Enter. For example, if you type BLUE in the field next to RED and press Enter, any panel element attributes defined as red change to blue.

You can restore an ISPF-defined color to its default value by setting its field to blank and pressing Enter. To restore all the ISPF-defined colors to their default values, select the Defaults point-and-shoot field at the end of the command line.

The EXIT command ends the Global Color Change Utility function and saves global color changes in the ISPSPROF system profile table. The CANCEL command ends the Global Color Change Utility function and restores the global color definitions as they were before the utility was invoked.

Changes to the globally defined colors affect all logical screens whether they are displayed directly by ISPF or whether ISPF has requested that GDDM perform the display. Line mode output, fields, and graphics that the dialog has placed on the screen using direct calls to GDDM are not affected by global color changes.

Global GUI color change utility: If you have set up the GUI interface, you can change its colors. From the Global GUI Color Change Utility panel shown in Figure 42, you can map each of the seven host colors to one of 16 workstation colors:

Host Colors	Workstation Colors
Red	Black
Pink	Dark blue
Green	Dark green
Yellow	Dark cyan
Blue	Dark red
Turq (turquoise)	Dark magenta
White	Brown
	Light gray
	Dark gray
	Light blue
	Light green
	Light cyan
	Light red
	Light magenta
	Yellow
	White

Choose colors that contrast with the panel background so that the text can be read easily.

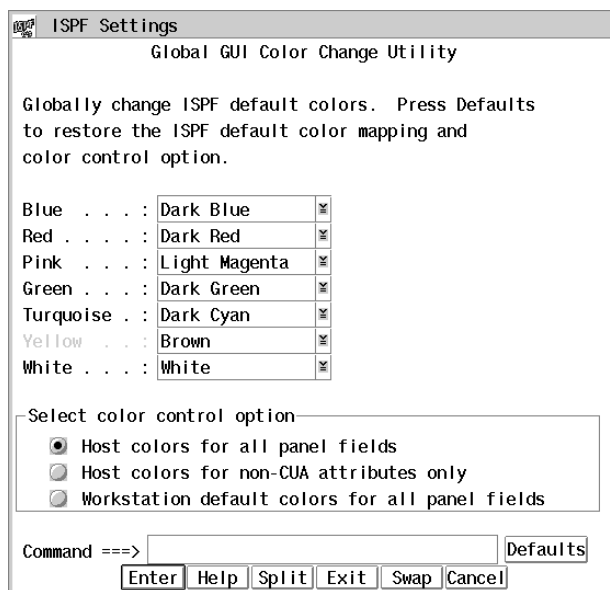

Figure 42. Global GUI color change utility panel (ISPOPTG1)

This panel provides three options for mapping host colors:

- 1 Host colors for all panel fields.** Any colors that you remap affect all panel fields.
- 2 Host colors for non-CUA attributes only.** Any colors that you remap affect only panel fields with non-CUA attributes.

Settings (option 0)

- 3 **Workstation default colors for all panel fields.** Remapping colors will have no effect.

The display will reflect any color changes made immediately when you press Enter.

Note: If a field uses a non-CUA attribute without a color specified, ISPF does not specify a color for the field and the field defaults to the 3270 default color on the host. That same field defaults to the workstation default color when it is displayed on the workstation, even if "Host colors for all panel fields" is selected.

Remapping host colors: From the Global GUI Color Change Utility panel, select a drop-down list button corresponding to one of the seven host colors, and ISPF displays the drop-down list on the panel, as shown in Figure 43.

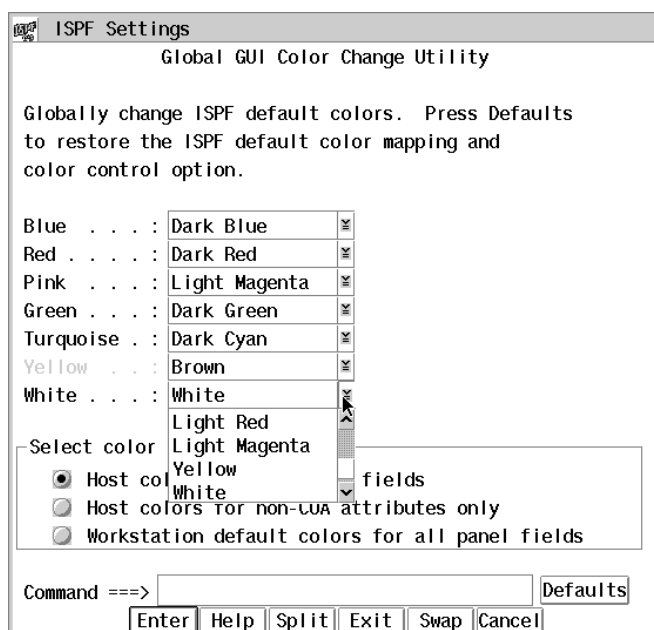

Figure 43. Color change panel with drop-down list

From the drop-down list, select one of the 16 workstation colors to map to the host color you selected. For example, if you select the workstation color light magenta to map to the host color red, any panel element attributes defined as red change to light magenta on the next display.

The EXIT command terminates the Global GUI Color Change Utility and saves any global color changes in the ISPSPROF system profile table. The CANCEL command terminates the Global GUI Color Change Utility and restores the global color definitions to the values that were in effect before the utility was invoked.

Changes to the globally defined colors affect all logical screens. Background panels and split screen panels are not immediately affected; the color change does not occur until the panels are redisplayed.

CUA attributes

ISPF provides the CUA Attribute Change Utility to allow you to change the default values of panel colors, intensities, and highlights for panel element attributes. See the *z/OS ISPF Dialog Developer's Guide and Reference* for a description of TYPE values for CUA panel element attributes.

To invoke the ISPF CUA Attribute Change Utility, perform one of these actions:

- Select the CUA attributes... choice from the Colors pull-down.
- Issue the ISPF system command CUAATTR from any ISPF command line.

The CUA Attribute Change Utility panel shown in Figure 44 is displayed. This is a scrollable panel that contains the current values for CUA panel element attribute colors, intensities, and highlights.

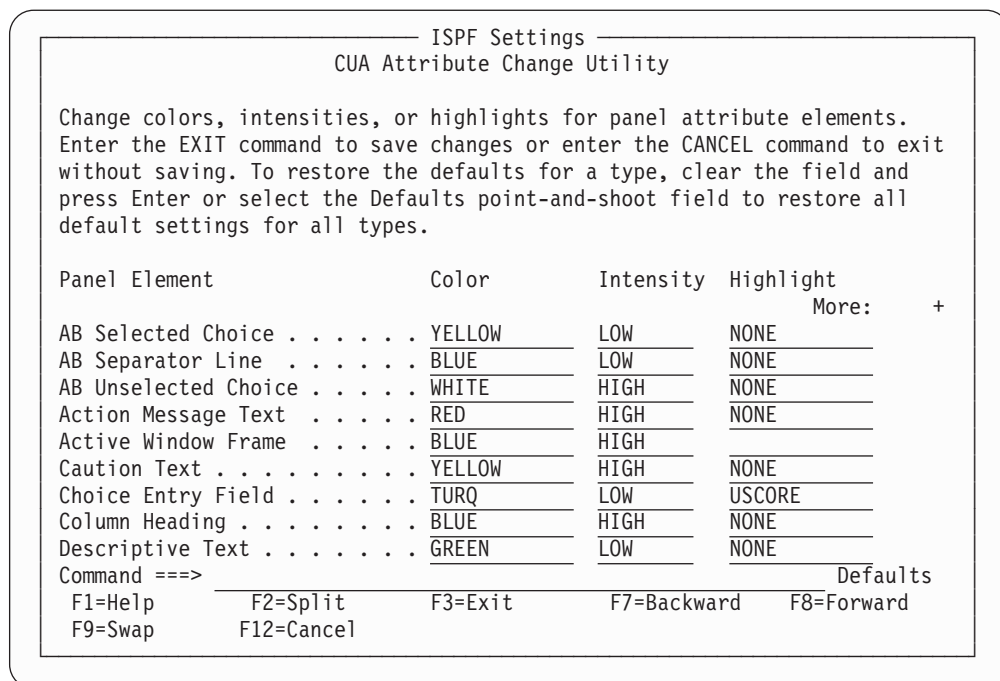

Figure 44. CUA Attribute Change Utility panel (ISPOPT11)

You can change the default values by typing over the existing values in the table with new values. Table 7 shows valid change values:

You can restore an attribute to its default value by setting its field to blank and pressing Enter. To restore all the attributes to their default values, select the Defaults point-and-shoot field at the end of the command line.

Table 7. Valid CUA attribute change values

Color Choices	Intensity Choices	Highlight Choices
RED	HIGH	NONE
PINK	LOW	BLINK
GREEN		REVERSE
YELLOW		USCORE
BLUE		
TURQ		
WHITE		

Settings (option 0)

In the CUA Attribute Change Utility table, if a field is left blank and Enter is pressed, the field defaults to the ISPF provided CUA-defined default value. Changes made to AB Selected Choice, AB Unselected Choice, Action Message Text, Function Keys, Informational Message Text, and Warning Message Text take effect immediately. Changes to other panel elements are reflected in the next panel display. The values of the panel colors, intensities, and highlights are saved across ISPF invocations in your ISPF system profile table, ISPSPROF. The changes to the panel element values affect all logical screens.

The CUA Attribute Change Utility affects only ISPF's CUA-defined attribute keywords. For example, the CUA Attribute Change Utility does not override this panel element attribute:

```
% TYPE(OUTPUT) COLOR(RED)
```

Color changes made using the ISPF Global Color Change Utility override changes made using the ISPF CUA Attribute Change Utility. For example, you can use the Global Color Change Utility and change red to blue. You might then use the CUA Attribute Change Utility and change normal text to red. Normal text will display as blue.

The ISPF-supported CUA-defined default values for the panel element attributes are listed in *z/OS ISPF Dialog Developer's Guide and Reference*.

Point-and-shoot

The Point-and-Shoot panel element on the CUA Attribute Change Utility panel (shown in Figure 45 on page 57) allows you to adjust the color, intensity and highlighting of point-and-shoot fields.

See the ISPF User Interface topic in the *z/OS ISPF User's Guide Vol I* for information on the point-and-shoot feature.

To display this panel, positioned on the Point-and-Shoot panel element, perform one of these actions:

- Select the Point-and-Shoot... choice from the Colors pull-down.
- Issue the ISPF system command PSCOLOR from any ISPF command line.

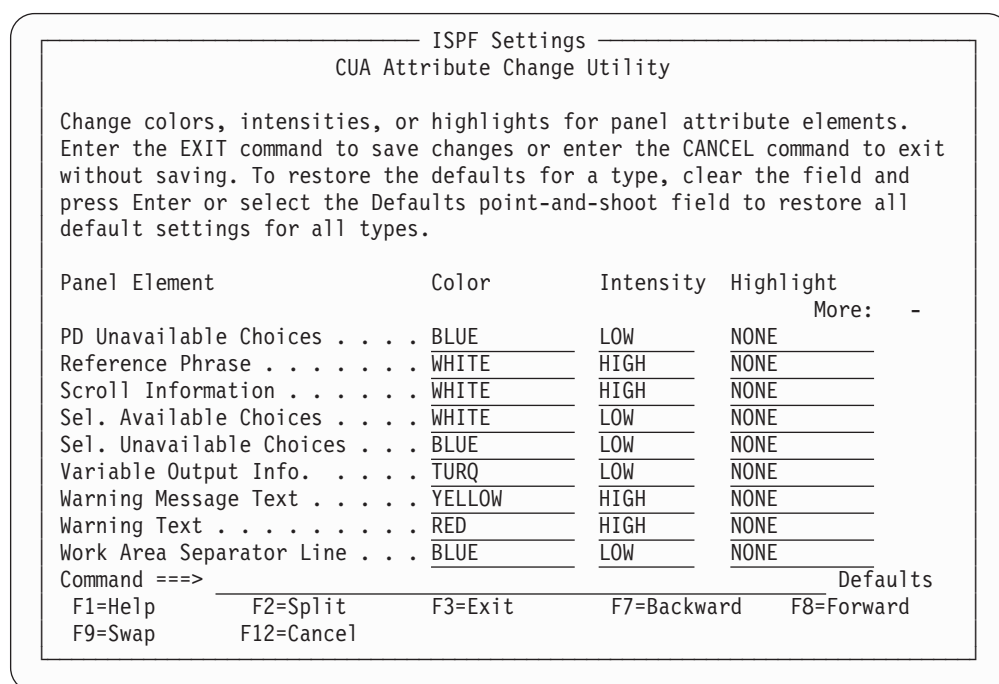

Figure 45. CUA Attribute Change Utility panel positioned on the point-and-shoot panel element (ISPOPT1X)

To change any of the three attributes, type over the existing values. The changes are reflected on the next panel displayed after you exit this panel. Table 8 shows valid change values:

Table 8. Valid point-and-shoot change values

Color Choices	Intensity Choices	Highlight Choices
RED	HIGH	NONE
PINK	LOW	BLINK
GREEN		REVERSE
YELLOW		USCORE
BLUE		
TURQ		
WHITE		

Specifying ISPF ENVIRON settings (the Environ action bar choice)

Figure 46 on page 58 shows the ISPF ENVIRON Command Settings panel from which you can choose parameter options for the ENVIRON command. To display this panel, perform one of these actions:

- Select the Environ choice on the ISPF Settings panel action bar, then select option 1, "Environ settings..."
- Issue the ISPF system command ENVIRON from any ISPF command line.

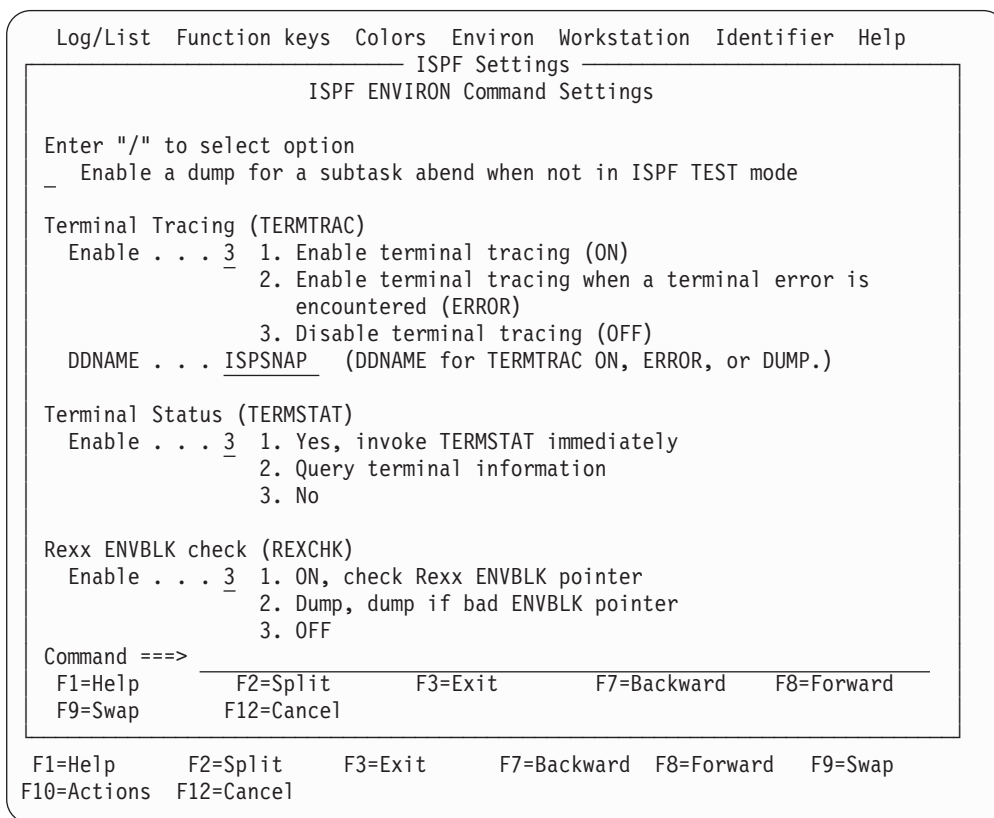

Figure 46. ISPF ENVIRON Settings panel (ISPENVA)

The panel text provides an overview of the command and its parameters. For a complete description of the ENVIRON command and its parameters, see *z/OS ISPF Dialog Developer's Guide and Reference*.

Specifying shared profile settings (the Environ action bar choice)

Figure 47 on page 59 shows the Multi-Logon Profile Sharing Settings panel from which you can choose parameter options for the SHRPROF command. To display this panel, perform one of these actions:

- Select the Environ choice on the ISPF Settings panel action bar, then select option 2, "Shared Profile settings...".
- Issue the ISPF system command SHRPROF from any ISPF command line.

```

Log/List  Function keys  Colors  Environ  Workstation  Identifier  Help
-----
ISPF Settings
e ISPISSA          Multi-Logon Profile Sharing Settings          e
e Command ==> _____ e
e
e Profile Enqueue settings e
e   Enter "/" to select option      ENQ Lock Wait . . . . . 1000 e
e   / Prompt for Profile ENQ Lockout  ENQ Lock Retry Count . . 1 e
e
e Profile conflicts e
e   System Profile conflicts          Reference List conflicts e
e   1 1. Keep                          1 1. Keep e
e   2 2. Discard                       2 2. Discard e
e   3 3. Prompt                         3 3. Prompt e
e
e   ISPF Profile conflicts            Edit Profile conflicts e
e   1 1. Keep                          1 1. Keep e
e   2 2. Discard                       2 2. Discard e
e   3 3. Prompt                         3 3. Prompt e
e
e   Application Profile conflicts     Batch Profile conflicts e
e   1 1. Keep                          1 1. Keep e
e   2 2. Discard                       2 2. Discard e
e   3 3. Prompt e
e
e   Other Profile conflicts e
e   1 1. Keep e
e   2 2. Discard e
e   3 3. Prompt e
e F1=Help      F2=Split      F3=Exit      F7=Backward  F8=Forward e
e F9=Swap      F12=Cancel e
e
F1=Help      F2=Split      F3=Exit      F7=Backward  F8=Forward  F9=Swap
F10=Actions  F12=Cancel

```

Figure 47. Multi-Logon Profile Sharing Settings (ISPISSA)

The panel text provides an overview of the command and its parameters. For a complete description of the SHRPROF command and its parameters, see *z/OS ISPF Dialog Developer's Guide and Reference*.

Specifying workstation parameters (the Workstation action bar choice)

Figure 48 on page 60 shows the Workstation pull-down menu on the ISPF Settings panel action bar.

Settings (option 0)

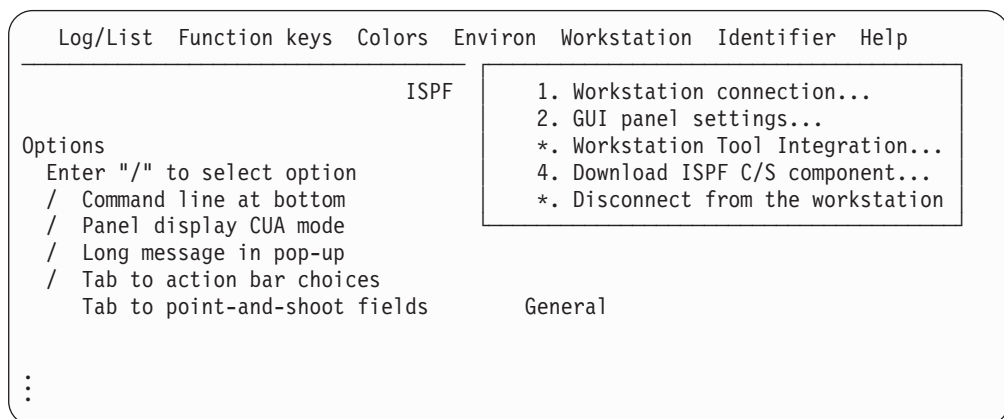

Figure 48. Workstation pull-down on the ISPF settings panel action bar (ISPISMMN)

From this pull-down you can start a workstation session, specify GUI panel settings, configure the Workstation Tool Integration dialog, download the ISPF C/S component, and disconnect from the workstation.

Before you can perform these tasks, you must have completed these tasks:

- Successful installation and initialization of TCP/IP or APPC.
'Appendix B: Configuring Communications for the ISPF Client/Server', in the *z/OS ISPF User's Guide Vol I*, contains procedures to help you to test whether you have satisfied this requirement.
- Successful installation of the ISPF Workstation Agent component.
See 'Appendix A: Installing the Client/Server component', in the *z/OS ISPF User's Guide Vol I* for additional information.
- Initialization of the ISPF WSA component.

To initialize the WSA:

- If you have created a shortcut on your desktop that automatically launches the WSA, double-click the icon.

If you do not have a shortcut icon:

1. Go to a command line in your operating system (Windows or UNIX).
2. Change to the directory that contains your WSA executable file.
3. Enter WSA.

The Workstation Agent window is displayed on your workstation.

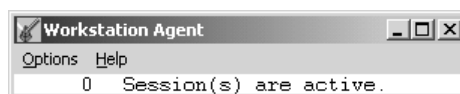

Figure 49. The Workstation Agent window

This window represents the executing ISPF C/S workstation program. For more information about this window, see 'Appendix A: Installing the Client/Server component', in the *z/OS ISPF User's Guide Vol I*. You can minimize this window but you cannot close it while ISPF is running in GUI mode.

Note: If you do not close the WSA window after you end an ISPF C/S session, you will not have to repeat this step to start another ISPF C/S session; that is, as long as the ISPF C/S component has been started, you can start a workstation session.

Note: You can specify the GUI panel settings without having established a workstation connection and without running in GUI mode. However, your changes will not be seen until you next run GUI mode.

Workstation connection

When you select “Workstation connection” from the Workstation pull-down, one of two events can occur. Either the Initiate Workstation Session panel is displayed, or ISPF tells you that a newer version of the Workstation Agent code is available (if your system programmer has not disabled this feature).

Initiate the workstation connection: If you select “Workstation connection” and your Workstation Agent code matches the latest level available, the Initiate Workstation Connection panel appears, as shown in Figure 50.

```

-          ISPF Settings          -
-          Initiate Workstation Connection          -
-
/  Save values in system profile?  (/=Yes)          +
0
Workstation Connection          GUI Network Protocol
1  1. With GUI display          1  1. TCP/IP
  2. Without GUI display        2. APPC
                                3. Use ISPDTPRF file

GUI Title
-----
TCP/IP Address
-----
APPC Address
-----

T  Host Codepage . . . ____   Host Character Set . . . ____

GUI Window Frame          Default Window Background Color
1  1. Standard (STD)      1  1. Dialog (DLG)
  2. Fixed (FIX)          2. Standard (STD)
  3. Dialog (DLG)

T  Press ENTER to initiate a session. Press EXIT or CANCEL to return
    without initiating a session.
Command ==>
C  F1=Help      F2=Split      F3=Exit      F7=Backward  F8=Forward
   F9=Swap      F12=Cancel
F

```

Figure 50. Initiate Workstation Connection panel (ISPISMG1)

Note: If your WSA is not running, this panel will appear but you will not be able to establish a connection.

The Initiate Workstation Session panel allows you to specify that you want to start a GUI session. Starting a GUI session from this panel if you are in split screen mode or 3290 partition mode is not supported. If you select Workstation connection, you must specify the information in these fields, as appropriate:

Settings (option 0)

Save values in system profile?

The default for this setting is YES. Any changes to this field are saved in the user's system profile.

Workstation connection

Allows you to specify one of these types of connections for your workstation session:

With GUI display

A GUI interface is provided for this session.

Without GUI display

A standard ISPF type of interface is provided for this session.

GUI Network Protocol

The type of network you use to connect the workstation to the host: TCP/IP or APPC.

You can also select the third option "Use ISPDTPRF file", to specify that ISPF get your network address from the file allocated to DD ISPDTPRF. The file can be sequential or a member of a PDS, and it can be fixed blocked (FB) or variable blocked (VB). Each line of the file should be formatted as follows: `userid WORKSTAT protocol_id:network_address`, where:

userid

user's TSO userid

protocol_id

network protocol identifier, either **ip** for TCP/IP or **lu** for APPC.

network_address

workstation address

For example, KEENE WORKSTAT ip:9.45.202.69.

GUI Title

The title you want displayed in the window frame of your GUI session. This value will be used if dialog variable ZWINTTL or ZAPPTTL is not found.

TCP/IP Address

The workstation's IP address. Required if you specified TCP/IP in the GUI Network Protocol field. The TCP/IP Address prompt is point-and-shoot text. If selected, a pop-up window is displayed containing the last five addresses saved in the system profile.

A TCP/IP address can be in dotted decimal format or in domain name format. Dotted decimal format is a sequence of decimal numbers separated by periods, for example, **9.87.654.321**.

A TCP/IP address in domain name format consists of one or more domain qualifiers separated by periods. The minimum specification for addresses within the same domain is a TCP/IP host name, for example, **jsmith**. The fully-qualified domain name for *jsmith* is formed by appending the appropriate subdomain name and root domain name to *jsmith*, such as **jsmith.raleigh.ibm.com**. To use domain naming, a domain name server must be active and providing domain name resolution for domain names within your TCP/IP network. The domain name server address is determined by the value of the **NSINTERADDR** statement in the TCP/IP configuration data set. ISPF must be able to locate the TCP/IP

configuration data set as described in the section on configuring TCP/IP connections in the *z/OS ISPF User's Guide Vol I*.

If an asterisk (*) is specified, the TCP/IP address is obtained automatically from the value of the system variable ZIPADDR.

APPC Address

The workstation's APPC network name. Required if you specified APPC in the GUI Network Protocol field. The APPC Address prompt is point-and-shoot text. If selected, a pop-up window is displayed containing the last five addresses saved in the system profile.

An APPC address can be in fully-qualified LU name format or in symbolic destination name format. A fully-qualified LU name format consists of a network identifier and an LU name, separated by a period. For example, **USIBMNR.NRI98X00** is a fully-qualified LU name.

An APPC address in symbolic destination name format consists of a 1- to 8-character name such as **JSMITH**. The symbolic destination name must be defined as a *DESTNAME* and the corresponding fully-qualified LU name must be defined as the associated *PARTNER_LU* in the APPC/MVS side information.

Host Codepage

The host code page value used in translating data from the host to the workstation. This value **must** be specified with a Host Character Set value if it is to be used. If only one, or neither, of these values is specified, the values from the terminal query are used. If your terminal or emulator does not support code pages, the CODEPAGE and CHARSET parameter values on the ISPSTART command are used. If the ISPSTART values are not specified, the default code page and character set is ENGLISH.

Host Character Set

The host character set value used in translating data from the host to the workstation. This value **must** be specified with a Host Codepage value if it is to be used. If only one, or neither, of these values is specified, the values from the terminal query are used. If your terminal or emulator does not support code pages, the CODEPAGE and CHARSET parameter values on the ISPSTART command are used. If the ISPSTART values are not specified, the default code page and character set is ENGLISH.

GUI Window Frame

Allows you to specify one of these types of window frames for your GUI session:

- 1 **Standard (STD)**. A GUI window frame that can be resized and that has max/min buttons.
- 2 **Fixed (FIX)**. A GUI window frame that has a min button but cannot be resized.
- 3 **Dialog (DLG)**. A GUI window frame that cannot be resized and that does not have max/min buttons.

Note: Pop-up panels will always be displayed in dialog window frames.

Default window background color

Select the background color:

Dialog (DLG)

Standard (STD)

Settings (option 0)

When you complete the fields shown in Figure 50 on page 61 and press Enter, the WSA connection panel is displayed in a separate window (unless your system has been set up to bypass it - see the topic about the System Register panel in “Installing the Client/Server component”, in the *z/OS ISPF User's Guide Vol I* for details).

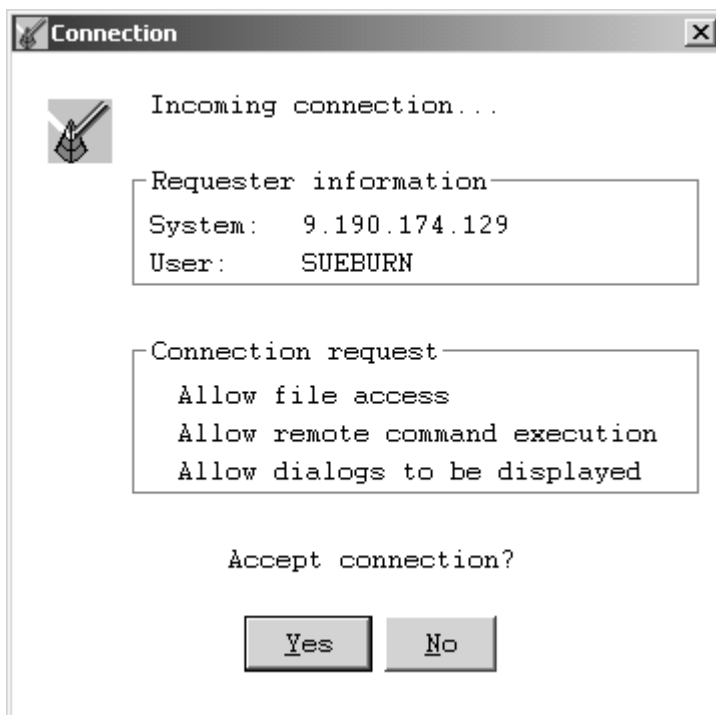

Figure 51. WSA connection panel

This panel indicates the requestor and the type of connection requested. Click on **Yes** to accept the connection as described, or **No** to reject the connection.

If you accept the connection, the ISPF Settings panel is displayed. This will be in standard or GUI mode, depending on the option selected in the With GUI display field.

Client/server component update: If you select “Workstation connection” but the WSA code does not match the latest level available, the Client/Server Component Update panel is displayed, as shown in Figure 52 on page 65.

Note: If you have not started the WSA, the Initiate Workstation Connection panel displays, but you will not be able to establish a connection.

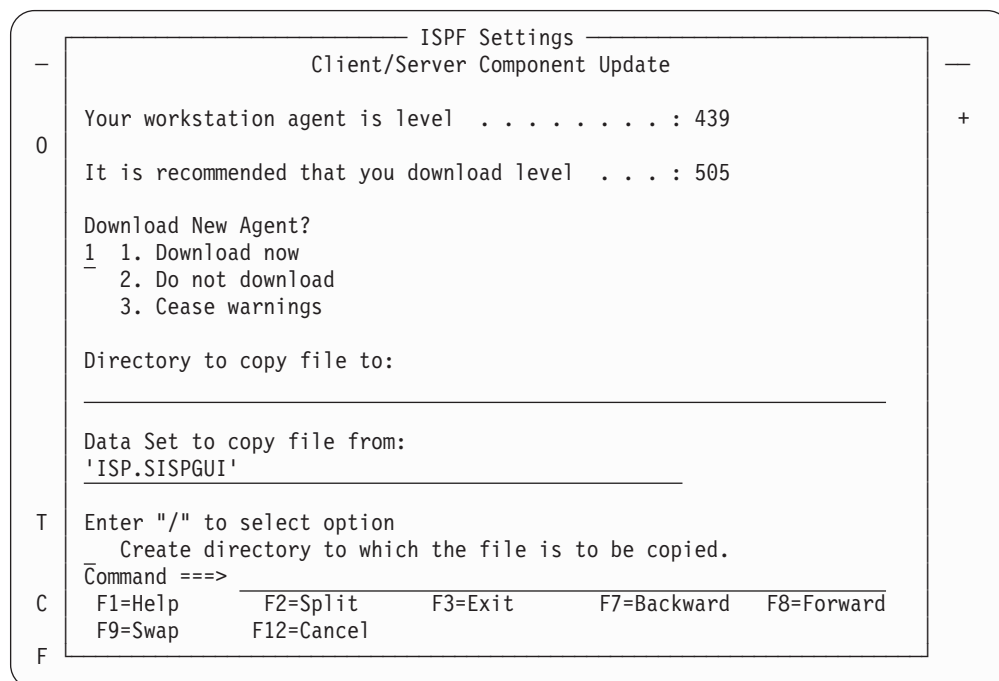

Figure 52. Client/Server Component Update panel (ISPDTVD1)

From this panel, you can download the latest WSA or continue to use your current WSA, and even tell ISPF not to notify you again if your WSA does not match the latest available. In the Download New Agent? field, you can specify one of three choices:

Download now

The download copies an installation program for the latest level of the WSA. You must specify the target directory in the “Directory to copy file to:” field. To create a new directory (one that does not already exist on your workstation) for the file, enter a slash mark (/) in the “Create directory to which the file is to be copied” field. The “Data Set to copy file from:” field should already be initialized by your system programmer. If it is not, you must specify the host data set that holds the latest WSA installation program. For example, 'SYS1.ISP.SISPGUI'.

After downloading the installation program for the WSA, end your ISPF/GUI connection, terminate your old Workstation Agent, and run the installation program to install the new one.

Do not download

You might want to download the new WSA later. If so, select “Do not download”. ISPF does not download the new installation program at this time, but will prompt you again the next time you start a GUI session. Of course, you can always download the agent yourself with the Client/Server Component download function of the ISPF Utilities panel at any time. See “Download data set to workstation utility (option 3.7)” on page 189 for more information.

Cease warnings

ISPF does not download the agent installation program *and* you will not be notified again that your current WSA does not match the latest available on the host until an even higher level is available. That is, if you currently run level 433 and you have asked to Cease warnings at level 440, ISPF will not notify you again until at least level 441 is available.

Settings (option 0)

Upon successful download of the new agent, the panel in Figure 53 appears. This panel gives you the option to end your GUI session and begin the installation immediately (by choosing option 1), or continuing your present session and installing the new Workstation Agent at a later time. See “Download data set to workstation utility (option 3.7)” on page 189 for more information.

```

-      ISPF Settings      -
-      ISPF Client/Server Component Install Program      -
0  The ISPF Client/Server Component workstation install program has been copied to your workstation in the current working directory of your current workstation agent.
+
  End your workstation connection and resume the installation by running the install program ISPFINST on your workstation in the working directory of your active workstation agent. The program is a self extracting executable that will result in additional files being generated on your workstation.
  Do you wish to end your workstation connection now?
  - 1. Yes, end workstation connection now
  - 2. No, do not end workstation connection now
T
C  Command ==>
F  F1=Help      F2=Split      F3=Exit      F7=Backward      F8=Forward
  F9=Swap      F12=Cancel

```

Figure 53. Client/Server Component Install Program panel (ISPWSD0A)

GUI panel settings

When you select “GUI panel settings” from the Workstation pull-down, the GUI Settings pop-up window is displayed, as shown in Figure 54 on page 67.

Note: You do not need to have a Workstation connection running, or to be in GUI mode, to change these settings.

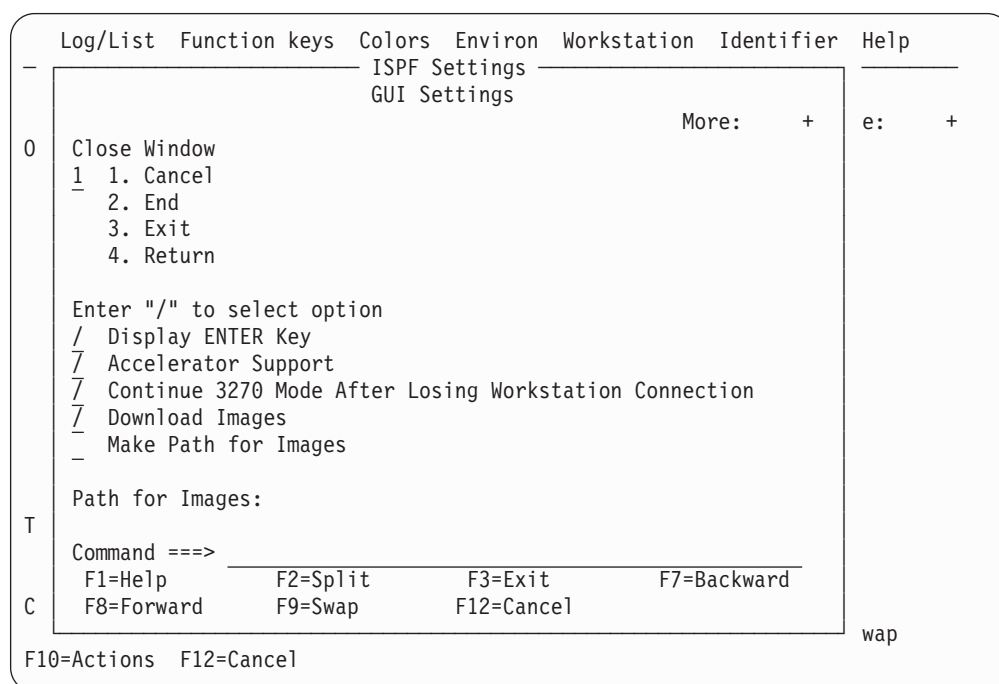

Figure 54. GUI settings pop-up window (ISPI SMGS)

The GUI Settings pop-up window allows you to specify these GUI parameters:

Close Window

Allows you to specify that one of these commands be processed when you close a GUI window:

- CANCEL
- END
- EXIT
- RETURN.

Display Enter Key

Select this field to display an Enter push button at the bottom of all GUI panels.

Accelerator Support

Select this field to use accelerator keys in this session.

3270 mode after losing workstation connection

Select this field if you want the ISPF session to continue in the 3270 emulator session rather than abend with code 989 when the workstation connection is lost while running in GUI mode.

Download Images

Select this field to download images *from* the host library defined to ddname ISPILIB, *to* the workstation image path. If you are not running ISPF in GUI mode, this setting is ignored.

Make Path for Images

Select this field to have ISPF create the image path you specify, when the image path you specify does not already exist on the workstation.

Path for images

In GUI mode, this field enables you to specify a workstation path for images. The image path can be 244 characters long with no embedded blanks. The image path you specify must follow the accepted path notation

Settings (option 0)

for whichever operating system you are using. If you do not specify an image path, ISPF puts the image requested into the workstation's working directory.

Workstation tool integration

ISPF enables you to edit host data on the workstation, and workstation data on the host. ISPF calls this function *distributed editing*.

The ISPF Workstation Tool Integration dialog, or tool integrator, is a workstation customization tool that enables any workstation application to use data from an MVS host system. After setting up the tool integrator, your workstation-installed applications can interact with the ISPF View and Edit functions and services. Data flow goes both ways with the tool integrator connection. You can work with workstation files on the host or with host files on the workstation.

Overall, the tool integrator enables MVS-based users to use workstation applications and then share data through MVS. MVS, its file system, and RACF®, provide data integrity, security, and distribution capabilities beyond the workstation. Sharing data this way can reduce your installation's dependence on complex LANs, off-load CPU cycles to your workstation, and take advantage of workstation tools.

Starting the tool integration dialog: Before you can use the tool integrator, the Workstation Agent must have been installed and configured. See “Workstation connection” on page 61 for details on these prerequisite tasks.

You can run the tool integrator in either GUI mode or the standard ISPF mode. For information about running ISPF in GUI mode, see the topic about the ISPF user interface in the *z/OS ISPF User's Guide Vol I*.

Note: You cannot issue a WSDISCON command or service call while running the workstation tool integration dialog.

You can display the Workstation Tool Integration Configuration panel, shown in Figure 55 on page 69, using any of these methods:

- Select Workstation Tool Integration from the Workstation pull-down.
- Select the Workstation choice on the action bars found on the Edit or View panels, then choose Workstation Tool Integration.
- Type INT on any ISPF command or action line and press Enter.

```

Log/List  Function keys  Colors  Environ  Workstation  Identifier  Help

  File  Map  Help
-----
                    Workstation Tool Integration Configuration

Press EXIT to save tool configuration to connected workstation hard drive.
Press CANCEL to temporarily update tool configuration for this session.

Action: E=Edit V=View

  Description  Code  Data   Mode   Command
  View         V    TEXT  MODELESS  e
  Edit         E    TEXT  MODAL     e
  **End**

Command ==> _____ Scroll ==> PAGE
F1=Help      F2=Split   F3=Exit    F7=Backward  F8=Forward
F9=Swap      F10=Actions F12=Cancel

Screen format  2  1. Data  2. Std  3. Max  4. Part
Command ==>
F1=Help      F2=Split   F3=Exit    F7=Backward  F8=Forward  F9=Swap
F10=Actions  F12=Cancel

```

Figure 55. ISPF Workstation Tool Integration panel

The information contained on this panel is defined as follows:

(Line command field)

Enter v (view) or e (edit) to display the Tool Configuration panel in View or Edit mode.

Description

Text explaining the ISPF action.

Code The ISPF action code assigned to this workstation application.

Data The format used for the object file during download and upload to the host.

Mode The processing mode for this action.

Command

The workstation invocation command string or name.

You use this panel to begin to define how the ISPF actions interact with the workstation applications, or just to look at the actions you have already defined.

The Tool Integrator action bar choices: These action bar choices are available on the Workstation Tool Integration panel:

File

Edit Calls the edit function to update the parameters of a workstation action.

View Displays the parameters of a particular action.

Cancel changes

Exit edit without updating the workstation action.

Exit and Save

Exit edit and save changes made to the workstation action parameters.

Settings (option 0)

Map

Extension

Starts the Extension Mapping dialog. See "Extension mapping" on page 71 for more information.

Updating an action: To update the configuration of an action, use either of these methods:

- Type e (edit) in the line command field next to View or Edit, and press Enter.
- Type / in the line command field next to View or Edit, then choose File > Edit from the action bars in the panel

After you choose to edit an action, the screen shown in Figure 56 is displayed.

Modify Tool Configuration				ier	Help
Description . . : View		Code . . : V		More: +	
Options					More: +
Data . . <u>1</u>	1. Text	Invocation <u>2</u>	1. Modal	2	
	2. Binary		2. Modeless	1	
Workstation command					
<u>e</u>					B
Additional parameters					;

Working directory					

F1=Help	F2=Split	F3=Exit	F7=Backward		
F8=Forward	F9=Swap	F12=Cancel		F9=Swap	

Figure 56. Modify Tool Configuration window

The fields found on this panel are as follows:

Description

Text explaining the ISPF action.

Code The ISPF action code assigned to this workstation application.

Data The format used for the object file during download and upload to the host. Use Binary for data that you want to leave unchanged on the host, for example, image files such as bitmaps.

Invocation

The processing mode for this action. Use Modal to ensure that an action is completed before your application moves on to another task. For example, if you want to upload and replace an object on the host, specify Modal. Modeless means that the action can continue while your application performs other tasks, effectively running in parallel with the application.

Workstation Command

The workstation invocation command string or name. This can be the actual command name of the workstation application, or a workstation path and command name.

Additional Parameters

Additional parameters that are recognized by the workstation command.

Working Directory

The directory on the workstation in which files used by Workstation Edit are stored. These include saved copies of workstation files and temporary copies of host files that are being processed by Edit or View on the workstation.

If you do not specify a location, a default directory is used. On Windows, the default is the directory where the ISPF WSA was started. On UNIX systems, the default is the user's home directory.

Extension mapping: The Map choice on the tool integrator action bar enables you to associate a workstation file extension of up to 3 characters with a host data set type. The host data set type is the last qualifier of the data set. These are frequently longer than 3 characters, while most workstation file extensions are 3 or less. The Extension Mapping dialog panel, shown in Figure 57, shows how certain host data set types map to their workstation file extension counterparts.

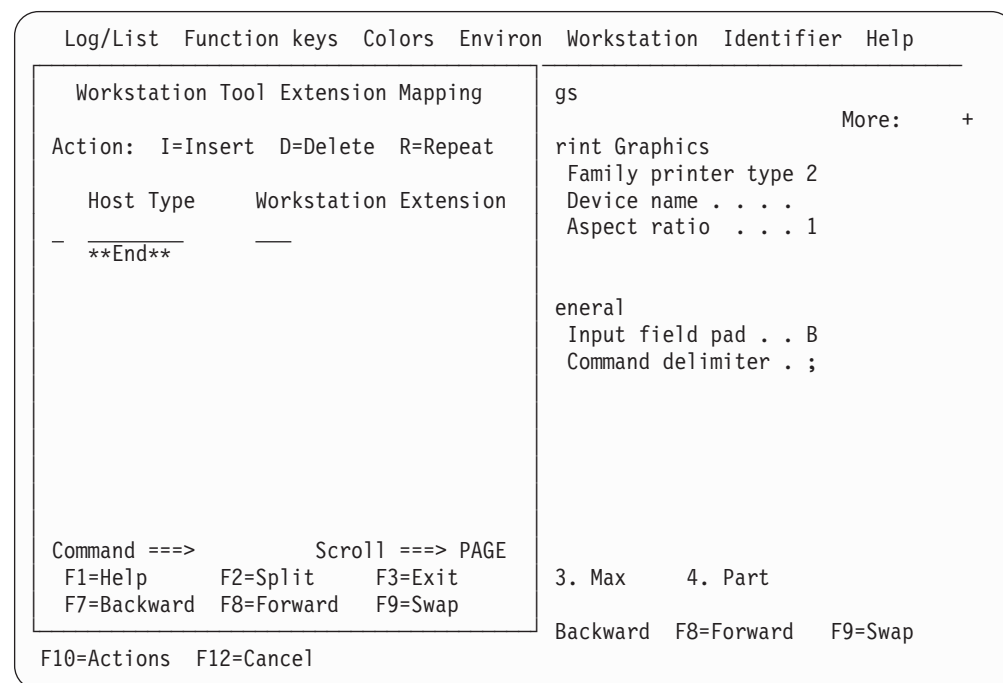

Figure 57. Extension Mapping Dialog window

To map a host to workstation pair, perform one of these actions:

1. In the Action field, type R to repeat a previous mapping, I to insert a new mapping, or D to delete a current mapping.
2. In the Host Type field, type the last qualifier of the host data set to be mapped.
3. In the Workstation Extension field, type the extension name to be used for the temporary workstation file created.
4. Press Enter.

Settings (option 0)

If you attempt to use a host data set on a workstation and you have not mapped the data set type to one on your workstation, the first 3 characters of the data set type are used by default.

Download ISPF C/S component

When you select "Download ISPF C/S Component" from the Workstation pull-down, the Client/Server component dialog starts. See "Download data set to workstation utility (option 3.7)" on page 189 for more information.

Disconnect from the workstation

When you select "Disconnect from the workstation" from the Workstation pull-down, the Workstation Disconnect Confirmation dialog starts. From the dialog you have the choice of YES to disconnect, or NO which cancels the disconnect request.

Displaying message, system, user, panel, and screen IDs

The Identifier action bar choice allows you to display message IDs with the message text, and to display system, user, panel, and screen identifiers at the start of the Title line.

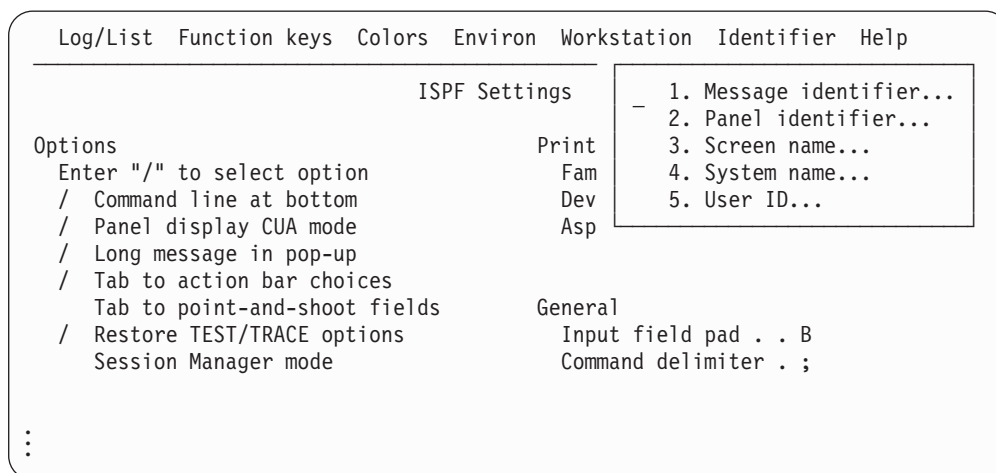

Figure 58. Identifier pull-down on the ispf settings panel action bar (ISPISMMN)

Message identifier

You can specify that you want to display message identifiers in either of two ways:

- Select the "Message identifier" choice from the Identifier pull-down on the ISPF Settings panel action bar, as shown in Figure 58.
- Issue the ISPF system command MSGID ON.

When you select "Message identifier" from the Identifier pull-down, the Message Identifier panel is displayed.

If you select the "Display message identifier" option, the message identifier is set to On. The identifier will now display within the message text whenever a long message option is accessed (that is, when you enter the HELP command). Deselect this choice (or issue the MSGID OFF command) to set the message identifier to Off.

This setting only applies to the current ISPF session. To retain the setting across ISPF sessions, select "Default setting for message identifier".

Figure 59 shows an error message on the ISPF Settings panel displayed with the message identifier set to on.

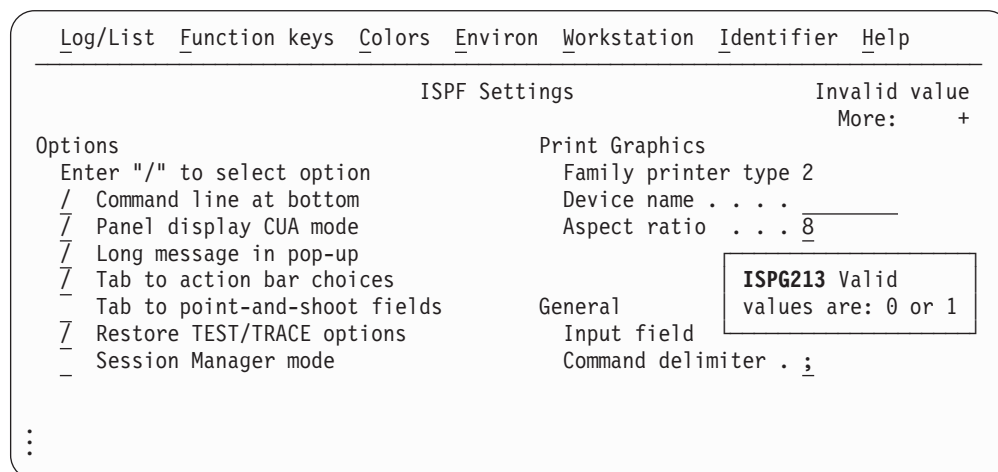

Figure 59. Panel displayed with the message identifier set to on

System name

You can specify that you want to display the system name in either of two ways:

- Select the “System name” choice from the Identifier pull-down on the ISPF Settings panel action bar.
- Issue the ISPF system command SYSNAME ON.

When you select “System name” from the Identifier pull-down, the System Name Identifier panel is displayed.

If you select the “Display system name identifier” option, the system name identifier is set to On. The identifier will now display in the panelid area. Deselect this choice (or issue the SYSNAME OFF command) to set the system name identifier to Off.

This setting only applies to the current ISPF session. To retain the setting across ISPF sessions, select “Default setting for system name”.

This figure shows the top portion of the ISPF Settings panel displayed with the screen identifier set to On.

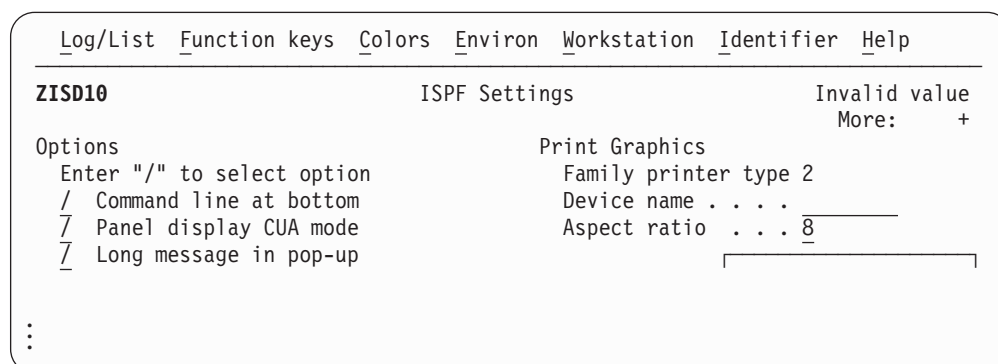

Figure 60. Panel displayed with the system name set to on

Settings (option 0)

Note: The commands SYSNAME, USERID, PANELID, and SCRNAME share the same 17-character area at the start of the Title line. If more than one of these commands are specified, ISPF displays as many as will fit, in this order of priority: SYSNAME, if specified, is always displayed. Then, as long as there is enough room, USERID is displayed, then PANELID, then SCRNAME.

User ID

You can specify that you want to display the user ID in either of two ways:

- Select the “User ID” choice from the Identifier pull-down on the ISPF Settings panel action bar.
- Issue the ISPF system command USERID ON.

When you select “User ID” from the Identifier pull-down, the User Identifier panel is displayed.

If you select the “Display user identifier” option, the user identifier is set to On. The identifier will now display in the panelid area. Deselect this choice (or issue the USERID OFF command) to set the user identifier to Off.

This setting only applies to the current ISPF session. To retain the setting across ISPF sessions, select “Default setting for user identifier”.

This figure shows the top portion of the ISPF Settings panel displayed with the user identifier (and the system name) set to On.

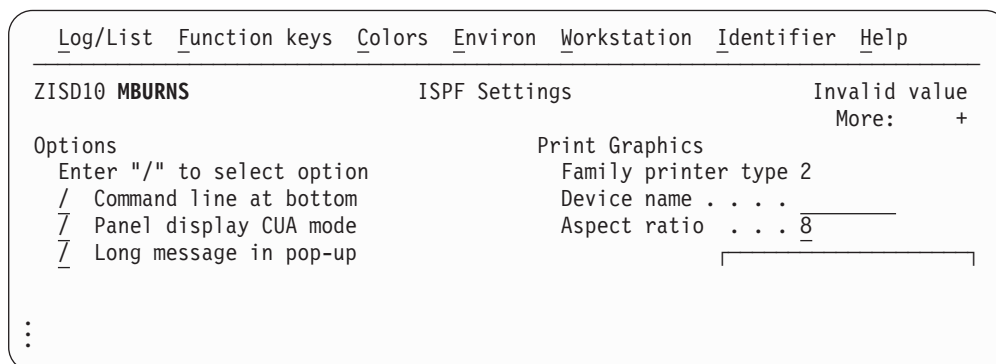

Figure 61. Panel displayed with the user ID set to on

Note: The commands SYSNAME, USERID, PANELID, and SCRNAME share the same 17-character area at the start of the Title line. If more than one of these commands are specified, ISPF displays as many as will fit, in this order of priority: SYSNAME, if specified, is always displayed. Then, as long as there is enough room, USERID is displayed, then PANELID, then SCRNAME.

Panel identifier

You can specify that you want to display panel identifiers in either of two ways:

- Select the “Panel identifier” choice from the Identifier pull-down on the ISPF Settings panel action bar, as shown in Figure 58 on page 72.
- Issue the ISPF system command PANELID ON.

When you select “Panel identifier” from the Identifier pull-down, the Panel Identifier panel is displayed.

If you select the “Display panel identifier” option, the panel identifier is set to On. The identifier will now display in the panelid area. Deselect this choice (or issue the PANELID OFF command) to set the panel identifier to Off.

This setting only applies to the current ISPF session. To retain the setting across ISPF sessions, select “Default setting for panel identifier”.

This figure shows the top portion of the ISPF Settings panel displayed with the panel identifier set to On.

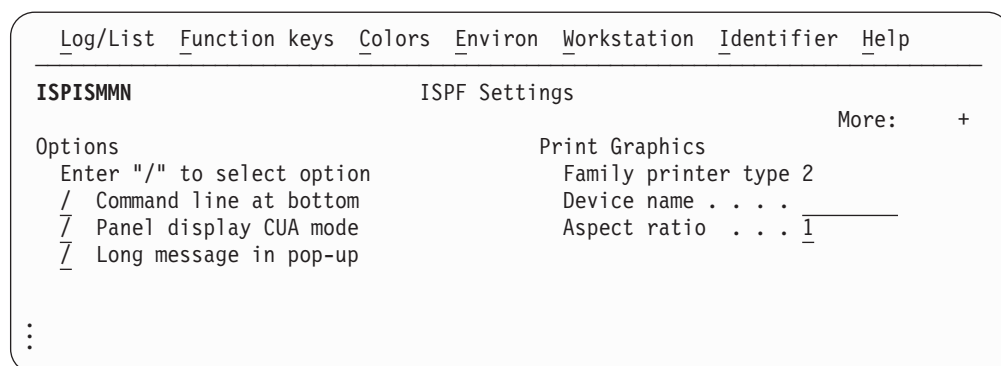

Figure 62. Panel displayed with the panel identifier set to on

Note: The commands SYSNAME, USERID, PANELID, and SCRNAME share the same 17-character area at the start of the Title line. If more than one of these commands are specified, ISPF displays as many as will fit, in this order of priority: SYSNAME, if specified, is always displayed. Then, as long as there is enough room, USERID is displayed, then PANELID, then SCRNAME.

Screen name

You can specify that you want to display the screen name in either of two ways:

- Select the “Screen name” choice from the Identifier pull-down on the ISPF Settings panel action bar.
- Issue the ISPF system command SCRNAME ON.

When you select “Screen name” from the Identifier pull-down, the Screen Name Identifier panel is displayed.

If you select the “Display screen identifier” option, the screen identifier is set to On. The identifier will now display in the panelid area. Deselect this choice (or issue the SCRNAME OFF command) to set the screen identifier to Off.

This setting only applies to the current ISPF session. To retain the setting across ISPF sessions, select “Default setting for screen identifier”.

This figure shows the top portion of the ISPF Settings panel displayed with the screen identifier set to On.

Settings (option 0)

```
  _Log/List  _Function keys  _Colors  _Environ  _Workstation  _Identifier  _Help
-----
SETTINGS                                ISPF Settings                                Invalid value
                                           More:      +
Options
Enter "/" to select option
 / Command line at bottom
 / Panel display CUA mode
 / Long message in pop-up
:
Print Graphics
Family printer type 2
Device name . . . .
Aspect ratio . . . 8
```

Figure 63. Panel displayed with the screen identifier set to on

Note: The commands SYSNAME, USERID, PANELID, and SCRNAME share the same 17-character area at the start of the Title line. If more than one of these commands are specified, ISPF displays as many as will fit, in this order of priority: SYSNAME, if specified, is always displayed. Then, as long as there is enough room, USERID is displayed, then PANELID, then SCRNAME.

Chapter 3. View (option 1)

The View option (1) displays the View Entry Panel shown in Figure 64.

```
Menu  RefList  RefMode  Utilities  Workstation  Help
-----
View Entry Panel
More:  +

ISPF Library:
Project . . . MYPROJ
Group . . . DEV . . . . .
Type . . . SOURCE
Member . . . (Blank or pattern for member selection list)

Other Partitioned, Sequential or VSAM Data Set, or z/OS UNIX file:
Data Set Name . . .
Volume Serial . . . (If not cataloged)

Workstation File:
File Name . . . . .

Options
Initial Macro . . . Confirm Cancel/Move/Replace
Profile Name . . . Browse Mode
Format Name . . . View on Workstation
Data Set Password . . Warn on First Data Change
Record Length . . . Mixed Mode
Line Command Table . .

Data Encoding (View mode only)
1. ASCII
2. UTF-8

Command ==>
F1=Help F2=Split F3=Exit F7=Backward F8=Forward F9=Swap
F10=Actions F12=Cancel
```

Figure 64. View Entry panel (ISRBR001)

This option enables you to view or browse source data and listings stored in ISPF libraries, other partitioned or single-volume or multivolume sequential data sets, or z/OS UNIX files.

View Allows you to use all Edit line commands, primary commands, and macros to manipulate the data. View functions exactly like Edit, with the exception of these primary commands:

SAVE When you enter the SAVE command, ISPF issues a message that you must use the CREATE command to save any data you have changed.

END When you enter the END command, ISPF terminates the View function; no data changes are saved.

Browse

Allows you to use the Browse primary commands described in “Browse primary commands” on page 81 to manipulate data.

View is enabled by default. You can disable View, thus allowing only Browse, by modifying the ISPF Configuration Table. You must set the keyword

View (option 1)

IS_VIEW_SUPPORTED to NO. For more information, see the topic about the ISPF Configuration Table in *z/OS ISPF Planning and Customizing*.

You can view or browse data that has these characteristics:

- Record Format (RECFM):
 - Fixed, variable (non-spanned), or undefined
- **Note:** If you try to view a data set with RECFM=U, the Browse function is substituted.
 - Blocked or unblocked
 - With or without printer control characters
- Logical Record Length (LRECL):
 - For fixed-length records, up to 32 760 characters. For view only, the minimum record length is 1 character.
 - For variable-length records, up to 32 756 characters. For view only, the minimum record length is 5 characters.
- VSAM data
 - VSAM data can be browsed if the ISPF Configuration table has been customized to enable VSAM support (that is, VSAM_BROWSE_ENABLED or VSAM_VIEW_ENABLED is set to "YES").
- **Note:** When VSAM support is enabled, the default value for VSAM_BROWSE_COMMAND and VSAM_VIEW_COMMAND is "FMNMAIN DSB /". If the command is not available, IKJ56500I COMMAND FMNMAIN NOT FOUND, is issued as a TSO message.
- z/OS UNIX files.

View Entry Panel action bar

The View Entry Panel action bar choices function as follows:

Menu See the details about the Action Bar Choice in the ISPF User Interface topic of the *z/OS ISPF User's Guide Vol I* for information about the Menu pull-down.

RefList

See the Using Personal Data Set Lists and Library Lists topic in the *z/OS ISPF User's Guide Vol I* for information about referral lists.

RefMode

See the information about Personal List Modes in the Using Personal Data Set Lists and Library Lists topic in the *z/OS ISPF User's Guide Vol I* for information about referral list modes.

Utilities

For more information, see the details about the Utilities Action Bar Choice in the ISPF User Interface topic in the *z/OS ISPF User's Guide Vol I*.

Workstation

The Workstation pull-down offers you one choice:

1. Workstation Tool Integration

See the information about the ISPF Workstation Tool Integration Program in the ISPF User Interface topic in the *z/OS ISPF User's Guide Vol I* for more information.

Help The Help pull-down provides general information about the options and commands available in View, as well as information about each available choice on the View Entry Panel.

View Entry Panel fields

The “ISPF Libraries and Data Sets” chapter of the *z/OS ISPF User’s Guide Vol I* contains information about all the fields on the View Entry Panel except these:

Initial Macro

You can specify an Edit macro to be processed before you begin viewing your sequential data set or any member of a partitioned data set. This initial macro enables you to set up a particular environment for the View session you are beginning.

If you leave the Initial Macro field blank and your Edit profile includes an initial macro specification, the initial macro from your Edit profile is processed.

If you want to suppress the processing of an initial macro in your Edit profile, enter NONE in the Initial Macro field.

Profile Name

You can specify a profile name to override the default Edit profile.

Format Name

Contains the name of a format definition, which is used to view or browse a formatted data set.

Browse Mode

Specifies that you want to browse the data set using the Browse function. This function is useful for large data sets and data sets that are formatted RECFM=U.

Confirm Cancel/Move/Replace

Specifies that you want ISPF to display a confirmation panel whenever you issue a Cancel, Move, or Replace command.

Mixed Mode

Specifies that you want to view or browse unformatted data that contains both EBCDIC and DBCS characters.

View on Workstation

Specifies that you want to view the data on your workstation. This option requires a workstation connection to be used.

Warn on First Data Change

Specifies that you want ISPF to warn you that changes cannot be saved in View. The warning is displayed when the first data change is made.

Record Length

Can be used when browsing a z/OS UNIX file. The numeric value entered in this field is used by ISPF to display the data in the file as fixed-length records, rather than using the newline character to delimit each record. This is useful for browsing files which would otherwise have very large records if the newline character is used as the record delimiter.

Data Encoding

You can use this option to select whether to view data as ASCII (CCSID 819) or UTF-8 (CCSID 1208). You can also specify this option when creating a new file, data set, or member containing ASCII or UTF-8 data. When you select a value for this option, the editor uses the selected CCSID in converting the data to the CCSID for the terminal.

For ASCII or UTF-8 z/OS UNIX files, the editor breaks up data into records using the ASCII linefeed character (X'0A') and the ASCII carriage

View (option 1)

return character (X'0D') as the record delimiter. The linefeed and carriage return characters are removed from the data loaded into the editor, but written back to the file when the data is saved.

It is not necessary to use the Data Encoding option when the z/OS UNIX file is tagged with a CCSID of 819 or 1208. If ISPF detects the file is tagged with CCSID 819 or 1208, it converts the data from ASCII or UTF-8 to the CCSID of the terminal. When the file is saved, ISPF ensures the file is tagged with a CCSID of 819 or 1208.

Browsing a data set

If you select Browse Mode on the View Entry Panel, ISPF displays either a member selection list or a Browse data display. For information about displaying a member list, see the topic about Using Member Selection Lists in the “ISPF Libraries and Data Sets” chapter of the *z/OS ISPF User's Guide Vol I*.

Note: If you specify a volume serial on the View Entry Panel, you can browse a single volume of a non-SMS multivolume data set.

A Browse data display is shown in Figure 65.

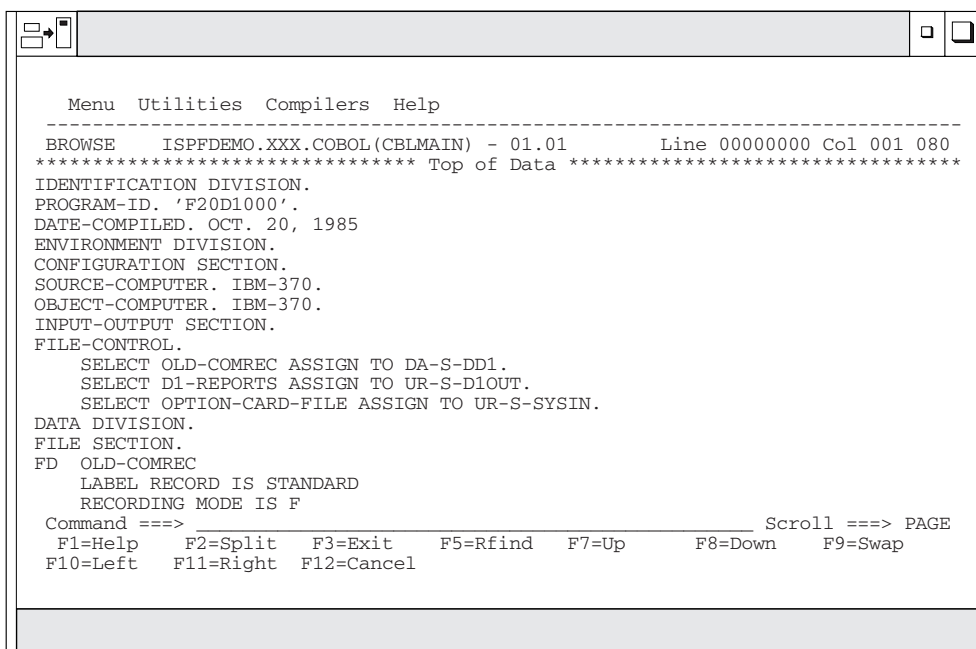

```
Menu Utilities Compilers Help
-----
BROWSE  ISPFDEMO.XXX.COBOL(CBLMAIN) - 01.01      Line 00000000 Col 001 080
***** Top of Data *****
IDENTIFICATION DIVISION.
PROGRAM-ID. 'F20D1000'.
DATE-COMPILED. OCT. 20, 1985
ENVIRONMENT DIVISION.
CONFIGURATION SECTION.
SOURCE-COMPUTER. IBM-370.
OBJECT-COMPUTER. IBM-370.
INPUT-OUTPUT SECTION.
FILE-CONTROL.
    SELECT OLD-COMREC ASSIGN TO DA-S-DD1.
    SELECT D1-REPORTS ASSIGN TO UR-S-D1OUT.
    SELECT OPTION-CARD-FILE ASSIGN TO UR-S-SYSIN.
DATA DIVISION.
FILE SECTION.
FD  OLD-COMREC
   LABEL RECORD IS STANDARD
   RECORDING MODE IS F
Command ==>
F1=Help  F2=Split  F3=Exit  F5=Rfind  F7=Up      F8=Down  F9=Swap
F10=Left F11=Right F12=Cancel
```

Figure 65. Browse - data display (ISRBRBOA)

Each character in the data that cannot be displayed is changed on the display to either a period or a character that you have specified. Using the DISPLAY command, you can specify whether printer carriage-control characters are to be treated as part of the data, and thus displayed.

You can browse data that is stored in a Unicode format. MVS Conversion Services must first be set up for the appropriate conversions. See *z/OS ISPF Planning and Customizing*.

During Browse, four-way scrolling is available through the scroll commands. You can also use the FIND and LOCATE commands to scroll to a particular character string, line number, or symbolic label.

Whenever you enter a command, such as FIND or one of the scroll commands, that puts the cursor under a character string in the data set, ISPF highlights that character string. This highlighting occurs whether you type the command on the command line and press Enter or press a function key that the command is assigned to.

Ending browse

To end a Browse data display, use the END command. This returns you to the previous panel, which is either a member list display or the View Entry panel. If a member list is displayed, the name of the member you just browsed is at the top of the list. You can select another member from the list or enter the END command again to return to the View Entry Panel.

When the View Entry Panel is displayed again, you can select another data set or member, or you can use the END command to return to the ISPF Primary Option menu.

Browse primary commands

You can prefix any BROWSE command with an ampersand to keep the command displayed on the command line after the command has been processed. This technique allows you to repeat similar commands without reentering the data. For example, if you enter:

```
Command ==>> &FIND ABCD
```

the command is displayed after the string has been found, which allows you to then change the operand and issue another FIND command.

Browse provides the functions described in these topics, each of which is controlled by a command that you can type on the command line:

- “BROWSE—browse recursively”
- “COLUMNS—identify columns” on page 82
- “DISPLAY—control the display” on page 83
- “EDIT—edit a member” on page 85
- “FIND—find character strings” on page 85
- “HEX—display data in hexadecimal format” on page 90
- “LOCATE—locate lines” on page 92
- “RESET—remove the column-identification line” on page 92
- “SUBMIT—submit a job stream for background execution” on page 92
- “VIEW—view a member” on page 93

BROWSE—browse recursively

The BROWSE command allows you to browse another member of the same data set. It also allows you to browse any other data set or a z/OS UNIX file without ending your current Browse session.

The BROWSE command has this syntax:

Browsing a data set

►► BROWSE ◀◀

where:

member

An optional member of the ISPF library or other partitioned data set that you are currently browsing. You may enter a member pattern to generate a member list.

For example, if you were browsing a member of library ISPFDEMO.XXX.COBOL, you could enter this command to display the panel shown in Figure 65 on page 80:

```
BROWSE CBLMAIN
```

If you do not specify a member name, the Browse Command - Entry Panel is displayed.

You end a nested Browse session the same way you would a normal one. When you end the nested Browse session, the current Browse session resumes.

COLUMNS—identify columns

You can use the COLUMNS command to provide a temporary indication of where columns occur on the panel. This command displays a column-identification line on the first line of the data area. The command has this syntax:

►► COLUMNS ON OFF ◀◀

where:

ON The default. Displays the column-identification line.

OFF

Removes the column-identification line from the display.

Note: You can also remove the column-identification line by entering the RESET command.

An example of the column-identification line is shown in Figure 66 on page 83. The digits on the identification line show the tens positions: 1 shows column 10, 2 shows column 20, and so forth. The plus signs (+) show the fives positions (columns 5, 15, 25, and so forth.)

```

  _Menu  _Utilities  _Compilers  _Help
  -----
BROWSE   SBURNF.CALL.TRACE                               Line 00000017 Col 001 080
Command ==>                                           Scroll ==> CSR
-----+-----1-----+-----2-----+-----3-----+-----4-----+-----5-----+-----6-----+-----7-----+-----8
  ISPVCALL Command: ISPVCALL
  ISPF Invocation  ISPF
  =====< Cached Panels >=====
  ISR@PRIM
  =====< Active Command Tables >=====
  USERCMDS  SITECMDS  ISPCMDS
  =====< Entries in Open Command Tables >=====
  :

```

Figure 66. Browse - column-identification line (ISRBROBA)

DISPLAY—control the display

The DISPLAY command allows you to view data that would not normally be displayed, such as carriage control characters and Unicode data. For other nondisplayable data you can specify a character to represent each character that cannot be displayed.

The DISPLAY command has two formats. The first is used to display carriage-control characters and other nondisplay characters. The second allows data stored using a Unicode CCSID (Coded Character Set Identifier) to be displayed using the CCSID of the terminal.

Carriage-control characters and other nondisplay characters

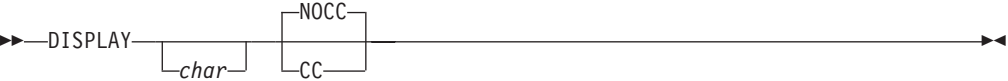

You must enter at least one operand, but you can enter them in any order. If you enter only one operand, the other operand retains its current value.

where:

char

The character you want to use to represent characters that cannot be displayed on the screen. It can be a single character, or a single character enclosed in apostrophes (') or quotation marks ("). If you specify a blank as the character, you must enclose it in apostrophes or quotation marks.

CC Shows that carriage control characters are to be displayed and are to be considered part of the data.

NOCC

Shows that carriage control characters are not to be displayed and are not to be considered part of the data.

Both operands are stored in your user profile and are in effect whenever you are using Browse. You need to reenter the DISPLAY command only if you want to change one of the operands.

Browsing a data set

The first settings for display mode are period (.) and NOCC, but the carriage control character status has no effect if the data that you are browsing has no carriage control characters.

Unicode data

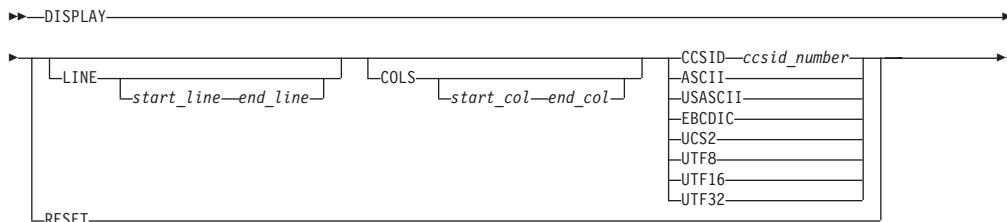

where:

LINE *start_line end_line*

Specifies the number of the first and last lines within which Unicode data is displayed. If the LINE keyword is not specified, the DISPLAY command applies to the all lines in the data. If only one value is specified, the DISPLAY command only applies to that line.

COLS *start_col end_col*

Specifies the number of the first and last column within which Unicode data is displayed. If the COLS keyword is not specified, the DISPLAY command applies to the full range of columns in the data. If only one value is specified, the DISPLAY command only applies to that column.

CCSID *ccsid_number* | **ASCII** | **USASCII** | **EBCDIC** | **UCS2** | **UTF8** | **UTF16** | **UTF32**

Specifies the CCSID of the data. The CCSID represents a code page and character set combination.

RESET

This format of the command resets all definitions made with the DISPLAY command. All data is displayed as though it had been stored using the terminal CCSID.

LINE and COLS are optional. LINE, COLS, and CCSID can be specified in any order.

You can issue multiple DISPLAY commands, in which case the specifications are merged. If a range of data is specified more than once, later specifications take precedence over earlier specifications. For example, if you specify one CCSID that applies to rows 3 to 10, then specify another CCSID that applies to columns 30 to 60, the second CCSID takes effect in the area where the DISPLAY commands overlap—that is, columns 30 to 60 in rows 3 to 10.

When you exit the current Browse session, all definitions are reset (as though you had entered DISPLAY RESET).

Examples:

- To use blanks to represent characters that cannot be displayed, enter:
DISPLAY " "
- To use a vertical bar (|) to represent characters that cannot be displayed, enter:
DISPLAY |

- To suppress the display of carriage control characters, enter:
DISPLAY NOCC
- To display columns 20 through 30 of lines 5 through 15 as though the data had been stored using a CCSID of UTF16:
DISPLAY LINE 5 15 COLS 20 30 CCSID 1200
- To display lines 4 through 18 as though the data had been stored using a CCSID of UTF16, except for column 72 in lines 12 through 18, which should be displayed as though the data had been stored using a CCSID of ASCII:
DISPLAY LINE 4 18 UTF16
DISPLAY LINE 12 18 COLS 72 ASCII
- To revert to displaying the data as though it had been stored using the CCSID of the terminal:
DISPLAY RESET

EDIT—edit a member

The EDIT command allows you to edit another member of the same data set. It also allows you to edit any other data set or z/OS UNIX file without ending your current Browse session.

The EDIT command has this syntax:

```

▶▶ EDIT _____
      |_____|
      member
  
```

where:

member

An optional member of the ISPF library or other partitioned data set that you are currently browsing. You may enter a member pattern to generate a member list.

For example, if you were browsing a member of library ISPFDEMO.XXX.COBOLE, you could enter this command to display the panel shown in Figure 65 on page 80:

```
EDIT CBLMAIN
```

If you do not specify a member name, the Edit Command - Entry Panel is displayed.

You end a nested Edit session the same way you would a normal one. When you end the nested Edit session, the current Browse session resumes.

FIND—find character strings

The FIND command allows you to find a specified character string. The syntax of the FIND command is:

```

▶▶ FIND string _____
      |_____| |_____| |_____| |_____|
      UTF8     | NEXT   | CHARS  | left_col-right_col
      ASCII    | ALL    | PREFIX|
      USASCII  | FIRST  | SUFFIX|
              | LAST   | WORD  |
              | PREV   |
  
```

Browsing a data set

Note: FIND as a Browse command, shown here, has the same syntax as FIND as an Edit command, except the optional X/NX/EX and line range operands are not included.

where:

string

Required operand. The character string you want to find.

NEXT | ALL | FIRST | LAST | PREV

Optional operands that define the starting point, direction, and extent of the search. NEXT is the default.

CHARS | PREFIX | SUFFIX | WORD

Optional operand. Operands that set the conditions for a character string match. CHARS is the default.

UTF8 | ASCII | USASCII

Optional operand which specifies that the FIND string is either a UTF8, ASCII, or USASCII character string. This form of the FIND command is only available for the character FIND command, and only for UTF8, ASCII, or USASCII strings.

left_col and right_col

Optional operands. Numbers that identify the columns the FIND command is to search.

You can separate the operands with blanks or commas and you can type them in any order, but *right_col*, if typed, must follow *left_col*.

Specifying find strings: The string operand specifies the characters to be found. For examples of different string formats, refer to the description of the FIND command in *z/OS ISPF Edit and Edit Macros*.

The default is not to differentiate between uppercase and lowercase characters when searching. Except for the character (C) string, differences between uppercase and lowercase strings are ignored. For example, this command:

```
FIND ALL 'CONDITION NO. 1'
```

successfully finds any of these:

```
CONDITION NO. 1  
Condition No. 1  
condition No. 1  
condition no. 1
```

Omitting string delimiters:

Generally, you enter the strings without delimiters. For example, to find all occurrences of ABC, enter:

```
FIND ALL ABC
```

Using string delimiters: You must use delimiters if a string contains embedded blanks or commas, or if a string is the same as a command keyword. You delimit strings with either apostrophes (') or quotation marks ("). For example, to find the next occurrence of every one, enter:

```
FIND 'every one'
```

The FIND command does not find the apostrophe or quotation mark string delimiters.

Note: The Browse FIND command does not work with a search argument that contains the command delimiter, even if string delimiters are used. You can specify a hexadecimal search string or use ISPF Option 0 to change the command delimiter to a different character.

Starting point, direction, and extent of search: You can control the starting point, direction, and extent of the search by using one of these operands:

- NEXT** The scan starts at the first position after the current cursor location and searches ahead to find the next occurrence of the string. NEXT is the default.
- ALL** The scan starts at the top of the data and searches ahead to find all occurrences of the string. A message in the upper-right corner of the screen shows the number of occurrences found. The second-level message that is displayed when you enter the HELP command shows which columns were searched.
- FIRST** The scan starts at the top of the data and searches ahead to find the first occurrence of the string.
- LAST** The scan starts at the bottom of the data and searches backward to find the last occurrence of the string.
- PREV** The scan starts at the first position before the current cursor location and searches backward to find the previous occurrence of the string.

If you specify FIRST, ALL, or NEXT, the direction of the search is forward; pressing the RFINd function key (F5/17) finds the next occurrence of the designated string. If you specify LAST or PREV, the direction of the search is backward; pressing the RFINd function key finds the previous occurrence of the string. The other optional operands remain in effect, as specified in the last FIND command. These operands include CHARS, WORD, PREFIX, SUFFIX, and *left_col*, *right_col*.

The search proceeds until one or all occurrences of the string are found, or until the end of data is found. If the string is not found, one of these actions takes place:

- If the FIND command was entered on the Command line, a NO *string* FOUND message is displayed in the upper-right corner of the screen.
- If the FIND command was repeated using the RFINd command, either a BOTTOM OF DATA REACHED message or a TOP OF DATA REACHED message is displayed, depending on the direction of the search. When these messages appear, you can press the RFINd function key again to continue the search by wrapping to the top or bottom of the data. If the string is still not found anywhere in the data, a NO *string* FOUND message is displayed.

Conditions for character string matches: The operands CHARS, PREFIX, SUFFIX, and WORD control the conditions for a successful match with the string based on whether the data string begins and/or ends with a non-alphanumeric character; that is, a special character or a blank. You can abbreviate PREFIX, SUFFIX, and CHARS to PRE, SUF, and CHAR, respectively.

In this example, the highlighted strings would be found and the strings that are not highlighted would be ignored:

Browsing a data set

```
CHARS 'DO' - DO DONE ADO ADOPT 'DO' +ADO (DONE) ADO-  
PREFIX 'DO' - DO DONE ADO ADOPT 'DO' +ADO (DONE) ADO-  
SUFFIX 'DO' - DO DONE ADO ADOPT 'DO' +ADO (DONE) ADO-  
WORD 'DO' - DO DONE ADO ADOPT 'DO' +ADO (DONE) ADO-
```

If you do not specify an operand, the default is CHARS.

Using text strings: Text strings are processed exactly the same as delimited strings. They are provided for compatibility with prior versions of the product.

Using character strings: A character string, which may be used as a string operand in a FIND command, requires that the search be satisfied by an exact character-by-character match. Lowercase alphabetic characters match only with lowercase alphabetic characters and uppercase alphabetic characters match only with uppercase.

If you specify a text string that contains any SO or SI characters, the string is considered a character string.

Specifying the keyword UTF8, ASCII, or USASCII with this form of the FIND command will find occurrences of 'string' within the data being browsed, where 'string' has been stored in the corresponding CCSID format.

Here are some examples:

To find the next occurrence of the characters XYZ only if they are in uppercase:
FIND C'XYZ'

To find the next occurrence of the characters xyz only if they are in lowercase:
FIND C'xyz'

To find the next occurrence of the UTF-8 string 'Found' (but not 'FOUND', 'found', or 'FoUnD'):
FIND C'Found' UTF8

Using picture strings: A picture string used as a string operand in a FIND command allows you to search for a particular type of character, without regard for the specific character involved. You can use special characters within the picture string to represent the type of character to be found, as follows:

String Meaning

P'=' Any character
P'~' Any nonblank character
P'.' Any nondisplayable (invalid) character
P'#' Any numeric character (0-9)
P'-' Any nonnumeric character
P'@' Any alphabetic character (uppercase or lowercase).

String Meaning

P'<' Any lowercase alphabetic character
P'>' Any uppercase alphabetic character
P'\$' Any special character (not alphabetic or numeric).

If an APL or TEXT keyboard is being used, this additional character can be used in a picture string:

P'␣ ' Any APL-specific or TEXT-specific character
 P'_' Any underscored alphabetic APL character and delta.

Only the special characters listed are valid within a picture string, but the string can include alphabetic or numeric characters that represent themselves.

A DBCS subfield cannot be specified as the subject of a picture string for the FIND command.

Examples of picture strings:

P'###'

A string of 3 numeric characters

P'␣ ␣'

Any 2 nonblank characters separated by a blank

P'.' Any nondisplayable character

P' #' A blank followed by a numeric character

P'#AB'

A numeric character followed by 'AB'.

Examples of FIND commands using picture strings:

FIND P'.'

Find next nondisplayable character

FIND P'␣' 72

Find next nonblank character in column 72

F P' ␣' 1

Find the next line with a blank in column 1 followed by a nonblank.

When you use the special characters '=' or '.' and a nondisplayable character is found, a hexadecimal representation is used in the confirmation message that appears in the upper-right corner of the screen. For example:

FIND P'..''

could result in the message CHARS X'0205' FOUND.

Column limitations: The *left_col* and *right_col* operands allow you to search only a portion of each line, rather than the complete line. These operands, which are integers separated by a comma or by at least one blank, show the starting and ending columns for the search. These rules apply:

- If you specify neither *left_col* nor *right_col*, the search continues across all columns within the current boundary columns.
- If you specify *left_col* without *right_col*, the string is found only if it starts in the specified column.
- If you specify both *left_col* and *right_col*, the complete string, not just part of it, must be within the specified columns.

Using RFIND: The RFIND command, which is usually assigned to the F5/17 key, allows you to repeat the previous FIND command without retyping it. Therefore, you can use this command to find successive occurrences of the string specified in the last FIND command. You can also use the RFIND command to return to the top of your data and continue searching when the BOTTOM OF DATA REACHED message appears. If you enter the RFIND command on the Command line instead of using a function key, you must position the cursor to the desired starting location before pressing Enter.

Browsing a data set

If you specify a 1-byte hexadecimal string as the FIND string and the string is found at the second byte of a double-byte character set (DBCS) character, hardware sets the cursor to the first byte of the character. If you then request RFIND, the same data is found again. To find the next occurrence of the string, you must move the cursor to the next character position before requesting RFIND again.

HEX—display data in hexadecimal format

The HEX command causes data to be displayed in hexadecimal format. The syntax of the command is:



You can specify the operands in any order:

where:

ON Turns hexadecimal mode on. This is the default.

OFF

Turns hexadecimal mode off.

VERT

Valid only when hexadecimal mode is ON. This is the default. Figure 67 on page 91 shows how VERT causes the hexadecimal representation to be displayed vertically, two rows per byte, under each character.

DATA

Valid only when hexadecimal mode is ON. Figure 68 on page 91 shows how DATA causes the hexadecimal representations to be displayed as a string of hexadecimal characters, two per byte. Because the hexadecimal string is twice the length of the data string, it occupies two rows. If you omit this operand, VERT is assumed.

When using browse and placing the cursor anywhere within the record, SCROLL UP positions the data where the cursor is located as the last complete line record on the display. A complete line record consists of the standard character form line, two hexadecimal character lines, and a separator line.

For example, this command would display the hexadecimal notation vertically:

```
HEX VERT
```

Three lines are displayed for each source line. The first line shows the data in standard character form. Figure 67 on page 91 shows the next two lines with the same data in vertical hexadecimal representation. A separator line is displayed between the two representations to make it easier for you to read the data.

```

Menu Utilities Compilers Help
-----
BROWSE -- USERID.PRIVATE.SCRIPT(BHEX) - 01.00 ----- Line 00000000 Col 001 076
***** Top of Data *****

-----
:H3 ID=BRHEX SUBJECT='BROWSE COMMANDS - HEX'.
7CF4CC7CDCC4EECDCE77CDDEEC4CDDDCDCE464CCE74
A83094E2985702421533ED296625036441542000857DB
-----
HEX - DISPLAYING DATA IN HEXADECIMAL FORMAT
CCE464CCEDDCECD4CCEC4CD4CCECCCCDCD4CDDDCDCE
8570004927318957041310950857145394130669413
-----
:P.THE DISPLAY OF DATA IN HEXADECIMAL NOTATION IS CONTROLLED BY THE HEX
7D4ECC4CCEDDCE4DC4CCEC4CD4CCECCCCDCD4DDECECD4CE4CDEDDDDCC4CE4ECC4CCE
A7B38504927318066041310950857145394130563139650920365396335402803850857
-----

Command ==> _____ Scroll ==> PAGE
F1=Help   F2=Split  F3=Exit   F5=Rfind  F7=Up     F8=Down   F9=Swap
F10=Left  F11=Right F12=Cancel

```

Figure 67. Browse hexadecimal display - vertical (ISRBROBA)

To display the hexadecimal notation horizontally, use this command:

HEX DATA

Figure 68 shows the next two lines with the same data in DATA hexadecimal representation.

```

Menu Utilities Compilers Help
-----
BROWSE -- USERID.PRIVATE.SCRIPT(BHEX) - 01.00 ----- Line 00000000 Col 001 076
***** Top of Data *****

-----
:H3 ID=BRHEX SUBJECT='BROWSE COMMANDS - HEX'.
7AC8F340C9C47EC2D9C8C5E740E2E4C2D1C5C3E37E7DC2D9D6E6E2C540C3D6D4D4C1D5C4E2406040
C8C5E77D4B
-----
HEX - DISPLAYING DATA IN HEXADECIMAL FORMAT
C8C5E7406040C4C9E2D7D3C1E8C9D5C740C4C1E3C140C9D540C8C5E7C1C4C5C3C9D4C1D340C6D6D9
D4C1E3
-----
:P.THE DISPLAY OF DATA IN HEXADECIMAL NOTATION IS CONTROLLED BY THE HEX
7AD74BE3C8C540C4C9E2D7D3C1E840D6C640C4C1E3C140C9D540C8C5E7C1C4C5C3C9D4C1D340D5D6
E3C1E3C9D6D540C9E240C3D6D5E3D9D6D3D3C5C440C2E840E3C8C540C8C5E7
-----

Command ==> _____ Scroll ==>
F1=Help   F2=Split  F3=Exit   F5=Rfind  F7=Up     F8=Down   F9=Swap
F10=Left  F11=Right F12=Cancel

```

Figure 68. Browse hexadecimal display - data (ISRBROBA)

You can use the FIND command to find invalid characters or any specific hexadecimal character regardless of the setting of hexadecimal mode. See the

Browsing a data set

syntax for picture strings and hexadecimal strings under the description of the FIND command in *z/OS ISPF Edit and Edit Macros*.

LOCATE—locate lines

Use the LOCATE command to bring a particular line to the top of the display. You can identify the line by either its relative line number or a previously defined label.

During Browse, the current position of the screen window is shown by the line/column numbers in the upper-right corner of the screen. The line number refers to the first line of data following the two header lines, and shows the relative position of that line in the data. The Top of Data message is treated as relative line zero. You must enter either a line number or a label as an operand.

```
▶▶—LOCATE—line-number————▶▶  
                  label
```

where:

line-number

A numeric value of up to 8 digits that shows the position of the line from the beginning of the data. The line number is displayed in the upper-right corner.

label

Defined by scrolling to the top of the screen the line with which you want to associate the label. You then type the label on the command line in the form:

```
.cccccc
```

For example, to find line 18463, you could enter this command:

```
LOCATE 18463
```

ISPF then moves line 18463 to the top of the screen. You can assign a label to it by entering:

```
.label
```

The label is a period followed by up to seven characters that can be displayed, except the comma and the space. It is treated as an internal symbol and is equated to the top line on the screen. You are required to specify the period when you define the label. The next time you want to find this line, you can enter:

```
LOCATE .label
```

The period is usually optional when you use it as an operand in a LOCATE command. However, if the first character in the label is a number, you must specify the period to distinguish the label from a line number.

The latest assignment of a label overrides any previous assignments. You can assign several labels to the same line. Labels are not retained when you leave the Browse option.

RESET—remove the column-identification line

The RESET command removes the column-identification line that you can display by using the COLUMNS command (see “COLUMNS—identify columns” on page 82). This command has no operands.

SUBMIT—submit a job stream for background execution

The SUBMIT command is used to submit a job stream that is being browsed. If the data set being browsed is modified and saved by another user or by the same user

on another screen, the SUBMIT command will submit the updated data set, not the copy being browsed. The TSO SUBMIT command is invoked directly to submit the job stream, so the data set has to be fixed-record format with a record length of 80.

Note: The Browse SUBMIT command is not supported if the underlying data is packed.

VIEW—view a member

The VIEW command allows you to view another member of the same data set. It also allows you to view any other data set or z/OS UNIX file without ending your current Browse session.

The VIEW command has this syntax:

```
▶—VIEW—┬──────────────────────────────────────────────────────────────────────────────────▶
          │
          └──member──┘
```

where:

member

An optional member of the ISPF library or other partitioned data set that you are currently browsing. You may enter a member pattern to generate a member list.

For example, if you were browsing a member of library ISPFDEMO.XXX.COBOL, you could enter this command to display the panel shown in Figure 65 on page 80:

```
VIEW CBLMAIN
```

If you do not specify a member name, the View Command - Entry Panel is displayed.

You end a nested View session the same way you would a normal one. When you end the nested View session, the current Browse session resumes.

Chapter 4. Edit (option 2)

The Edit option (2) allows you to create, display, and change data stored in ISPF libraries, other partitioned or single-volume or multivolume sequential data sets, or z/OS UNIX files with these characteristics:

- Record Format (RECFM):
 - Fixed or variable (non-spanned)
 - Blocked or unblocked
 - With or without printer control characters
- Logical Record Length (LRECL):
 - From 1 to 32 760, inclusive, for fixed-length records
 - From 5 to 32 756, inclusive, for variable-length records.
- VSAM data
 - VSAM data can be edited if the ISPF Configuration table has been customized to enable VSAM support (that is, VSAM_EDIT_ENABLED is set to "YES").

Note: When VSAM support is enabled, the default value for VSAM_EDIT_COMMAND is "FMNMAIN DSE /". If the command is not available, IKJ56500I COMMAND FMNMAIN NOT FOUND, is issued as a TSO message.

- z/OS UNIX files.

Editing a data set

When you select the Edit option, the Edit Entry Panel shown in Figure 69 on page 96 is displayed.

Edit (option 2)

```
Menu  RefList  RefMode  Utilities  Workstation  Help
-----
                                Edit Entry Panel

ISPF Library:
Project . . . MYPROJ
Group . . . . DEV . . . . . . . . . .
Type . . . . SOURCE
Member . . . _____ (Blank or pattern for member selection list)

Other Partitioned, Sequential or VSAM Data Set, or z/OS UNIX file:
Data Set Name . . . _____
Volume Serial . . . _____ (If not cataloged)

Workstation File:
File Name . . . . . _____

Initial Macro . . . . _____ Options
Profile Name . . . . _____ / Confirm Cancel/Move/Replace
Format Name . . . . _____ - Mixed Mode
Data Set Password . . _____ - Edit on Workstation
Record Length . . . . _____ - Preserve VB record length
Line Macro Table . . . _____ - Edit ASCII data
Command ==>>>
F1=Help    F2=Split    F3=Exit    F7=Backward  F8=Forward  F9=Swap
F10=Actions F12=Cancel
```

Figure 69. Edit Entry panel (ISREDM01)

Edit Entry Panel action bar

The Edit Entry Panel action bar choices function as follows:

Menu See the details about the Menu Action Bar Choice in the ISPF User Interface topic in the *z/OS ISPF User's Guide Vol I* for information about the Menu pull-down.

RefList See the Using Personal Data Set Lists and Library Lists topic in the *z/OS ISPF User's Guide Vol I* for information about referral lists.

RefMode See the details about Personal List Modes in the Using Personal Data Set Lists and Library Lists topic in the *z/OS ISPF User's Guide Vol I* for information about referral list modes.

Utilities For more information, see the details about the Utilities Action Bar Choice in the ISPF User Interface topic in the *z/OS ISPF User's Guide Vol I*.

Workstation Configure ISPF workstation tool integration.

Help The Help pull-down provides general information about the Edit environment as well as information about the main options and edit commands.

Edit Entry Panel fields

You can specify a concatenated sequence of up to four ISPF libraries, but the libraries must have been previously allocated to ISPF with the Data Set utility (3.2).

The fields on this panel are:

Project

The common identifier for all ISPF libraries belonging to the same programming project.

Group The identifier for the particular set of ISPF libraries; that is, the level of the libraries within the library hierarchy.

You can specify a concatenated sequence of up to four existing ISPF libraries.

The editor searches the ISPF libraries in the designated order to find the member and copies it into working storage. If the editor does not find the member in the library, it creates a new member with the specified name.

When you save the edited member, the editor places or replaces it in the first ISPF library in the concatenation sequence, regardless of which library it was copied from.

Type The identifier for the type of information in the ISPF library.

Member

The name of an ISPF library or other partitioned data set member. Leaving this field blank or entering a pattern causes PDF to display a member list. See *z/OS ISPF User's Guide Vol I* if you need information about entering patterns.

Name Any fully qualified data set name or z/OS UNIX file path name.

For more details about the Name field, see the "ISPF Libraries and Data Sets" chapter of the *z/OS ISPF User's Guide Vol I*.

Volume Serial

A real DASD volume or a virtual volume residing on an IBM 3850 Mass Storage System. To access 3850 virtual volumes, you must also have MOUNT authority, which is acquired through the TSO ACCOUNT command.

Workstation File:

If you have made a connection to the workstation, you can specify a workstation file name, for example C: \AUTOEXEC.BAT, in this field.

Initial Macro

You can specify a macro to be processed before you begin editing your sequential data set or any member of a partitioned data set. This initial macro allows you to set up a particular editing environment for the Edit session you are beginning. This initial macro overrides any IMACRO value in your profile.

If you leave the Initial Macro field blank and your edit profile includes an initial macro specification, the initial macro from your edit profile is processed.

If you want to suppress an initial macro in your edit profile, type NONE in the Initial Macro field. See the topics about Initial Macros and the IMACRO primary command in the *z/OS ISPF Edit and Edit Macros* for more details.

Profile Name

The name of an edit profile, which you can use to override the default edit profile. See the topics about Edit Profiles and the edit environment in the *z/OS ISPF Edit and Edit Macros*.

Edit (option 2)

Format Name

The name of a format definition or blank if no format is to be used.

Data Set Password

The password for OS password-protected data sets. This is not your RACF password.

Record Length

Applicable when editing a z/OS UNIX file. ISPF normally treats z/OS UNIX files as having variable length records. This field allows you to specify a record length which is used by the editor to load the records from the file into the edit session as fixed-length records. When the file is saved, it is saved with fixed-length records. The Record Length field allows you to convert a variable-length file to fixed length. The value specified in this field must be able to accommodate the largest record in the file. If the editor finds a record that is larger than the length specified, an error message is displayed and the edit session does not proceed.

Line Macro Table

Use this field to define a set of user line commands that you can use during the edit session. The table you specify can be generated using the ISPF table editor and contains the line commands that you wish to have available and associates each line command with an edit macro that will be run if the line command is entered during the edit session.

Confirm Cancel/Move/Replace

When you select this field with a "/", a confirmation panel displays when you request one of these actions, and the execution of that action would result in data changes being lost or existing data being overwritten.

- For MOVE, the confirm panel is displayed if the data to be moved exists. Otherwise, an error message is displayed.
- For REPLACE, the confirm panel is displayed if the data to be replaced exists. Otherwise, the REPLACE command functions like the edit CREATE command, and no confirmation panel is displayed.
- For CANCEL, the confirmation panel is displayed if any data changes have been made, whether through primary commands, line commands, or typing.

Note: Any commands or data changes pending at the time the CANCEL command is issued are ignored. Data changes are "pending" if changes have been made to the displayed edit data, but no interaction with the host (ENTER, PF key, or command other than CANCEL) has occurred. If no other changes have been made during the edit session up to that point, the confirmation panel is not displayed.

Mixed Mode

When you select this field with a "/", it specifies that the editor look for shift-out and shift-in delimiters surrounding DBCS data. If you do not select it, the editor does not look for mixed data.

Edit on Workstation

You can select this option to use your workstation as the editing environment for whichever host data set or workstation file you want to edit.

Preserve VB record length

When you select this field with a "/", it specifies that the editor store the original length of each record in variable-length data sets and when a record is saved, the original record length is used as the minimum length

for the record. The minimum length can be changed using the SAVE_LENGTH edit macro command. The editor always includes a blank at the end of a line if the length of the record is zero or eight.

Data Encoding

You can use this option to select whether to edit data as ASCII (CCSID 819) or UTF-8 (CCSID 1208). When you select a value for this option, the editor uses the selected CCSID in converting the data to the CCSID for the terminal.

For ASCII or UTF-8 z/OS UNIX files, the editor breaks up data into records using the ASCII linefeed character (X'0A') and the ASCII carriage return character (X'0D') as the record delimiter. The linefeed and carriage return characters are removed from the data loaded into the editor, but written back to the file when the data is saved.

It is not necessary to use the Data Encoding option when the z/OS UNIX file is tagged with a CCSID of 819 or 1208. If ISPF detects the file is tagged with CCSID 819 or 1208, it converts the data from ASCII or UTF-8 to the CCSID of the terminal. When the file is saved, ISPF ensures the file is tagged with a CCSID of 819 or 1208.

Distributed editing

If you have made a connection to the workstation, you can also specify a workstation file name such as C: \AUTOEXEC.BAT on the Edit Entry Panel. Or you can specify which environment (host or workstation) should be used to edit a data set. With these options, one of four editing situations can occur:

- Edit a host data set on the host
- Edit a host data set on the workstation
- Edit a workstation file on the host
- Edit a workstation file on the workstation.

Edit a Host Data Set on the Host

The editor searches the ISPF libraries in the designated order to find the member and copy it into working storage. If you specified a nonexistent member of an ISPF library, a new member is created with the specified name.

When you save the edited member, the editor places or replaces it in the first ISPF library in the concatenation sequence, regardless of which library it was copied from.

Edit a Host Data Set on the Workstation

The editor searches the ISPF libraries in the designated order to find the member and copy it into working storage. The data set name is converted to a workstation file name, and that name is appended to the workstation's current working directory. The host data set is transferred to the workstation, and the working file is then passed to the user's chosen edit program.

When you finish the edit session, the working file is transferred back to the host and stored in the first ISPF library in the concatenation sequence.

Edit a Workstation File on the Host

The editor searches the workstation files to find the desired file and copy it into working storage. The workstation file name is converted to a host data set name, and, if greater than 44 characters, it is truncated to be 44. The workstation file is transferred to the host, where you can edit it.

Edit (option 2)

When you finish the edit session, the working file is transferred back to the workstation and stored.

Edit a Workstation File on the Workstation

This edit proceeds as it normally does on your workstation.

Note: Some file names are reserved or restricted depending on the workstation operating system. An attempt to edit a file name that is reserved or restricted by your operating system might cause your workstation operating system or host system to hang. See your workstation operating system documentation to learn restricted or reserved file names.

Double-byte character set support

The ISPF editor supports DBCS alphabets in two ways:

- Formatted data where DBCS characters are in the column positions specified in the format definition created with the Format Utility (option 3.11)
- Mixed characters delimited with the special shift-out and shift-in characters.

If you are using mixed mode and the record length of a data set is greater than 72 bytes, there is a possibility that a DBCS character might encroach on the display boundary. Here, PDF attempts to display the other characters by replacing an unpaired DBCS character byte with an SO or SI character. If there is a possibility that the replaced SO or SI character was erased, the line number of the line is highlighted. If you change the position of the SO and SI characters on the panel, or if you delete the SO and SI characters entirely, the DBCS character on the boundary is removed to keep the rest of the data intact.

Chapter 5. Utilities (option 3)

The Utilities option (3) provides a variety of functions for library, data set, and catalog maintenance, each of which is described in this topic. The Utility Selection Panel is shown in Figure 70.

<u>M</u> enu	<u>H</u> elp
Utility Selection Panel	
1 Library	Compress or print data set. Print index listing. Print, rename, delete, browse, edit or view members
2 Data Set	Allocate, rename, delete, catalog, uncatalog, or display information of an entire data set
3 Move/Copy	Move, or copy members or data sets
4 Dslist	Print or display (to process) list of data set names. Print or display VTOC information
5 Reset	Reset statistics for members of ISPF library
6 Hardcopy	Initiate hardcopy output
7 Transfer	Download ISPF Client/Server or Transfer data set
8 Outlist	Display, delete, or print held job output
9 Commands	Create/change an application command table
11 Format	Format definition for formatted data Edit/Browse
12 SuperC	Compare data sets (Standard Dialog)
13 SuperCE	Compare data sets Extended (Extended Dialog)
14 Search-For	Search data sets for strings of data (Standard Dialog)
15 Search-ForE	Search data sets for strings of data Extended (Extended Dialog)
16 Tables	ISPF Table Utility
17 Udlist	Print or display (to process) z/OS UNIX directory list
Option ==>	
F1=Help	F2=Split F3=Exit F7=Backward F8=Forward F9=Swap
F10=Actions	F12=Cancel

Figure 70. Utility Selection Panel (ISRUTIL)

Utility Selection Panel action bar

The Utility Selection Panel action bar choices function as follows:

Menu For more information, see the details about the Menu Action Bar Choice in the ISPF User Interface topic in the *z/OS ISPF User's Guide Vol I*.

Help The Help pull-down provides information about each available choice on the Utilities Menu.

Library utility (option 3.1)

When you select this option, a panel is displayed (Figure 71 on page 102) that allows you to specify a data set and an action to be performed. The Library utility is intended primarily for maintenance of partitioned data sets. However, the print index listing (X), print entire data set (L), data set information (I), and short data set information (S) functions also apply to sequential data sets.

Library utility (option 3.1)

```
Menu RefList Utilities Help
-----
Library Utility
More: +
blank Display member list I Data set information B Browse member
C Compress data set S Short data set information D Delete member
X Print index listing E Edit member R Rename member
L Print entire data set V View member P Print member

Enter "/" to select option
ISPF Library: / Confirm Member Delete
Project . . . MYPROJ - Enhanced Member List
Group . . . DEV . . . . .
Type . . . SOURCE
Member . . . (If B, D, E, P, R, V, or blank selected)
New name . . (If R selected)

Other Partitioned or Sequential Data Set:
Data Set Name . . .
Volume Serial . . . (If not cataloged)

Option ==>
F1=Help F2=Split F3=Exit F7=Backward F8=Forward F9=Swap
F10=Actions F12=Cancel
```

Figure 71. Library Utility panel (ISRUDA1)

Library Utility panel action bar

The Library Utility panel action bar choices function as follows:

Menu For more information, see the details about the Menu Action Bar Choice in the ISPF User Interface topic in the *z/OS ISPF User's Guide Vol I*.

RefList

For information about referral lists, see the details about Using Personal Data Set Lists and Library Lists in the *z/OS ISPF User's Guide Vol I*.

Utilities

For more information, see the details about the Utilities Action Bar Choice in the ISPF User Interface topic in the *z/OS ISPF User's Guide Vol I*.

Help The Help pull-down provides information on the options available for processing libraries and members, including compressing and printing partitioned data sets, displaying data set information and member lists, and printing, renaming, deleting, browsing, editing, and viewing members.

Library Utility panel fields

All the fields on the Library Utility panel, with the exception of the "New name" field, are discussed in the Libraries and Data Sets topic in the *z/OS ISPF User's Guide Vol I*. The "New name" field is required when option R (rename member) is chosen; the field must contain the new member name. See "R — rename member" on page 112 for more information about this option.

Library utility options for data sets

The topics listed here describe the options shown on the left side of the Library Utility panel shown in Figure 71. These options are used to work with data sets.

- "Blank — (display member list)" on page 103
- "C — compress data set" on page 103

- “X — print index listing” on page 104
- “L — print entire data set” on page 104
- “I — data set information” on page 104
- “S — short data set information” on page 108

Blank — (display member list)

If you leave the Option field blank, you must specify a partitioned data set. ISPF displays a member list when you press Enter. For more information, see the details about Using Member Selection Lists and Library and Data Set List Utility Line Commands in the Libraries and Data Sets topic in the *z/OS ISPF User's Guide Vol I*.

Note:

1. The column headers on a member list display (with the exception of Rename) are point-and-shoot sort fields.
2. If you enter a slash in the 1-character or 9-character command field, the Member List Commands pop-up window shown in Figure 72 is displayed so that you can select the command you want to use.
3. The 1-character or 9-character line command field is a point-and-shoot field. If you select the line command field beside a member name, the Member List Commands pop-up window shown in Figure 72 is displayed so that you can select the command you want to use. In addition, you can enter commands (for example, TSO) directly in the 9-character field.
4. You can *chain* the P, R, D, V, E, and B commands; that is, you can select multiple members from a member list for various processing tasks. Use the CANCEL command (from a View, Browse, or Edit session) to break the chain and return to the member list.

Menu Functions Confirm Utilities Help	
ISRCMLEP	Action for Member TEST
/	Member Action
—	1. Edit
	2. View
	3. Browse
	4. Delete
	5. Rename
	6. Print
	7. Move
	8. Copy
	9. Reset
	10. Open Edit
	11. Submit
	12. TSO Cmd
	13. WS Cmd
	14. Select **None**
Prompt Action . . _____ (For prompt field)	
Select a choice and press ENTER to continue	
F1=Help	F2=Split
F7=Backward	F8=Forward
F3=Exit	F9=Swap
Row 00001 of 00001	
anged	ID
08 13:32:15	GRAHAMP
Command ==>>	
F1=Help	F2=Split
F10=Left	F11=Right
F3=Exit	F12=Cancel
F5=Rfind	F7=Up
F8=Down	F9=Swap
Scroll ==>> PAGE	

Figure 72. Member list commands pop-up window (ISRCMLEP)

C — compress data set

If you select option C, you can specify any partitioned data set. The compress function is not valid for a PDSE. The compress is accomplished by calling either of these:

Library utility (option 3.1)

- The IEBCOPY utility
- An optional compress request exit routine, which can be specified by your installation.

Using this option can change an existing data set allocation to *exclusive*.

ISPF allocates the IEBCOPY SYSUT3 and SYSUT4 data sets as one primary cylinder, one secondary cylinder. If this is not sufficient for your compress request, these DDNAMES can be preallocated.

X — print index listing

If you select option X, you must specify either a DASD-resident sequential or partitioned data set. The index listing is recorded in the ISPF list data set. For a partitioned data set, the index listing includes general information about the data set followed by a member list. For a sequential data set, the index listing includes general information only. See the topic about Listing Formats in *z/OS ISPF User's Guide Vol I* for examples of the index listing format for source libraries and load libraries.

Note:

1. A volume serial is not allowed for multivolume data sets using option X.
2. If ISPF was entered in TEST mode, the listing also includes TTR data for each member of the data set. This data is the track and record address, where the members reside on the volume.

L — print entire data set

If you select option L, you must specify either a DASD-resident sequential or partitioned data set. The allowable data set characteristics are the same as for Browse, except that data sets with a logical record length greater than 300 characters are not printed. Also, the data should not contain any printer control characters. Use the Hardcopy utility (option 3.6) to print data sets that contain printer control characters. A source listing of the complete data set (including all members of a partitioned data set), preceded by an index listing, is recorded in the ISPF list data set.

Note:

1. A volume serial is not allowed for multivolume data sets using option L.
2. The page-numbering format of the ISPF list data set is PAGE: XX of YY. The YY value is calculated using the data set member's current size statistic. When the member's current size is larger than the actual member size, the result is PAGE: XX of YY, where YY is a page number greater than the last value of XX. When the size statistic is smaller than the actual member size, the result is PAGE: XX of YY, until the actual size number XX exceeds YY. Then the result is PAGE: XX, until the end of the member is processed.

I — data set information

If you select option I, the location, characteristics, and current space utilization of the specified data set are displayed. The format ISPF uses to display data set information when DFSMSdfp is not installed or is not available, or when the Storage Management Subsystem is not active, is shown in "U — uncatalog data set" on page 124. See "Information for managed data sets" on page 107 to see how ISPF displays data set information when these products are installed, available, and active.

For sequential data sets, options I and S display the same information. For multivolume data sets, options I and S display current allocation and utilization values that represent totals from all volumes used. You may not enter a volume serial when you are requesting information on a multivolume data set.

Note:

1. The space for data sets allocated in blocks is calculated as if all of the tracks, including the last one, contain only full blocks of data. Any partial “short” blocks are ignored.
2. The information shown for current space utilization is the actual data that the data set contains, based on the number of allocation units (blocks, tracks, bytes, megabytes, and so on) that have been written. For a data set allocated in units other than tracks and cylinders, it does not include the unused portion of a track that is only partially filled.

For example, if a data set allocated in bytes with block size of 600 has one block written to a device with a track size of 1000, 600 bytes of data are written and the remaining 400 bytes cannot be used by a different data set. A track is the smallest possible unit of physical allocation to a data set on DASD. ISPF reports 600 bytes used while other products (such as ISMF) report 1000 bytes used. ISPF reports the space occupied by data in the data set. ISMF reports the space used by this data set that is not available for use by another data set. The difference is a relative indication of the effectiveness of the block size used when the data set was created.

```

                                Data Set Information
Data Set Name . . . . : MYPROJ.DEV.SOURCE

General Data                                Current Allocation
Management class . . . : STANDARD          Allocated cylinders : 1
Storage class . . . . : BASE               Allocated extents . : 1
Volume serial . . . . : MVS8WF            Maximum dir. blocks : 20
Device type . . . . . : 3390
Data class . . . . . : **None**
Organization . . . . . : PO
Record format . . . . : FB
Record length . . . . : 80
Block size . . . . . : 27920
1st extent cylinders: 1
Secondary cylinders : 1
Data set name type  : PDS

                                Current Utilization
Creation date . . . . : 2002/07/08        Used cylinders . . . : 1
Expiration date . . . : ***None***        Used extents . . . . : 1
                                Used dir. blocks . . . . : 1
                                Number of members . . . : 1

                                Referenced date . . . : 2002/07/23

Command ==>
F1=Help      F2=Split    F3=Exit      F7=Backward  F8=Forward   F9=Swap
F12=Cancel

```

Figure 73. Data Set Information panel (ISRUAIIP)

If the volume serial is followed by a plus (for example, HSM016+), the data set spans multiple volumes. Press Enter to display a list of all allocated volumes that have been used, as shown in Figure 74 on page 106.

Library utility (option 3.1)

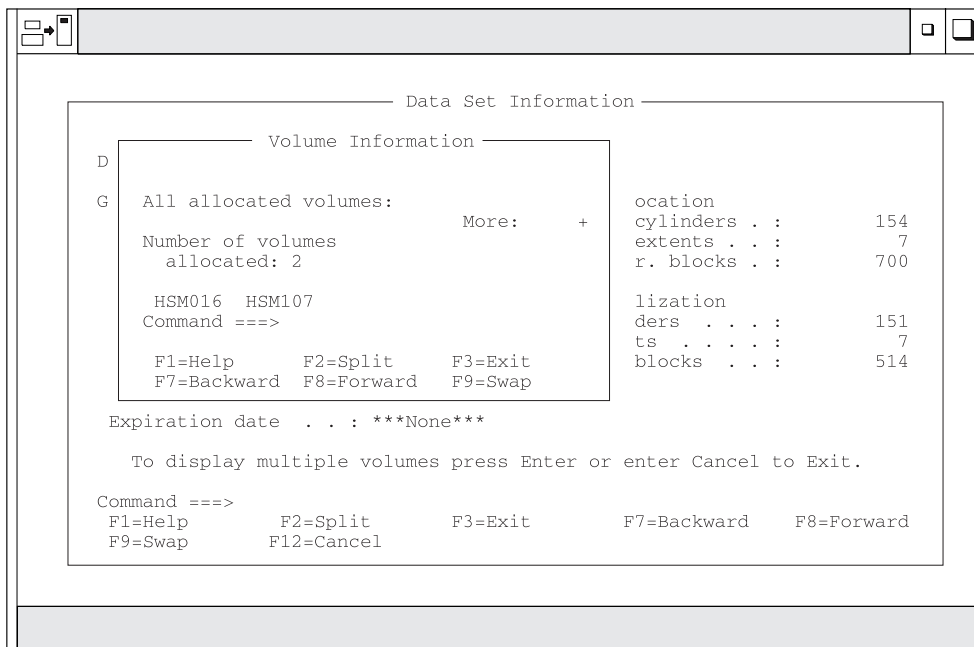

Figure 74. Volume Information for a Multivolume Data Set (ISRUAMVI)

The “Allocated units” and “Used units” fields can vary, depending on the value that was specified in the “Space units” field when you allocated the data set. For example, Figure 74 shows what the Data Set Information panel would look like if the data set was allocated by specifying Cylinders in the “Space units” field.

If directory block information is not available, the Data Set Information panel shows a value of 0 * for the “Maximum dir. blocks”, “Used dir. blocks”, and “Number of members” fields. The asterisk beside the zero refers you to a note on the panel, which states that the directory is unavailable.

If the data set is a PDS, ISPF must open it to retrieve the directory information. This updates the referenced date for the next time option I is displayed.

If the data set is a PDSE, the “Data set name type” field is LIBRARY and the “Maximum dir. blocks” field is NOLIMIT. Because the used blocks, used extents, and used directory blocks are not applicable to a PDSE, the Data Set Information panel replaces these values with “Used pages” and “% Utilized” (Figure 75 on page 107). Other values that can appear in the “Data set name type” field are:

- HFS - MVS Hierarchical File System data set
- EXTENDED - DFSMSdfp Striped data set
- LARGE - Large format sequential data set

Note: When a PDSE data set is created, it sets aside five pages. This may cause a significant change to the “% Utilized” value for a small data set.

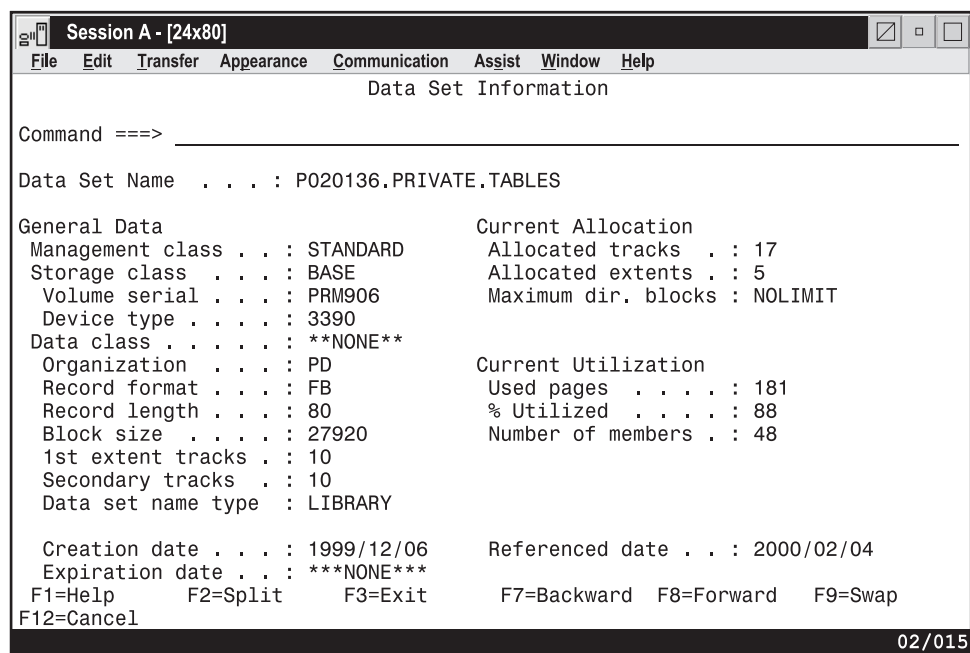

Figure 75. Data Set Information for PDSE Managed Data Sets (ISRUAISE)

Information for managed data sets: The Library Utility option I (Figure 76) displays information for data sets that reside on Storage Management Subsystem Volumes (also called managed data sets) when:

- DFSMSdftp is installed and available.
- Storage Management Subsystem is active.
- Directory block information is available.

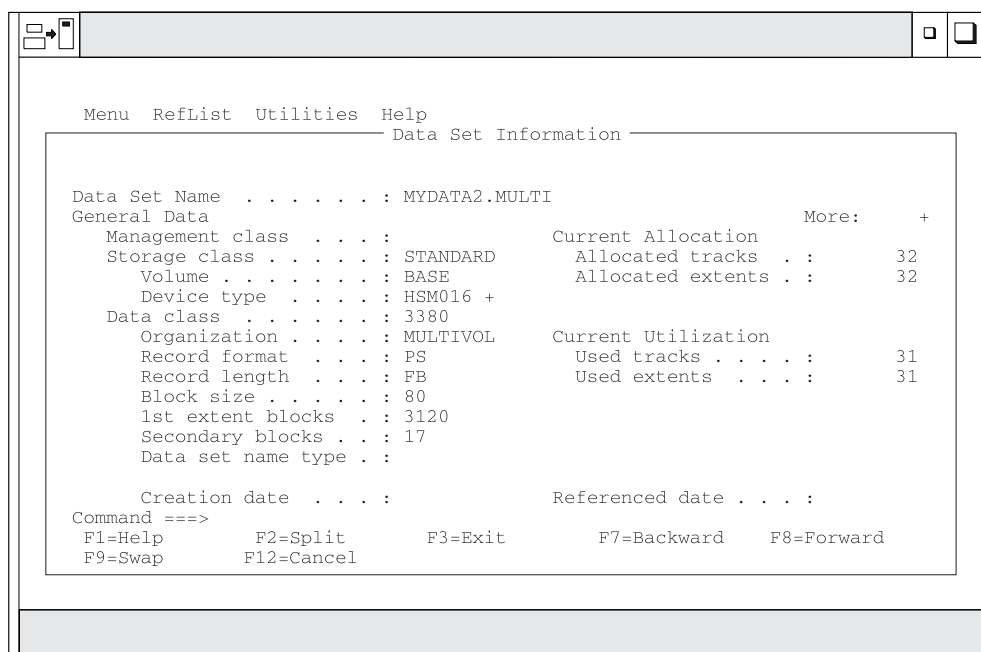

Figure 76. Data Set Information for Managed Data Sets (ISRUAISE)

Library utility (option 3.1)

Note: A "+" may be displayed beside the Volume serial field if the data set is a multiple volume data set. This is determined from the number of volume entries in the catalog. Depending on the system set-up, a "+" may not be displayed until the additional volumes have been accessed. For example, a data set with a non-zero dynamic volume count in the SMS dataclass will not show multiple volume entries in the catalog until the additional volumes have been accessed. Other vendor products which can dynamically expand the volume list will also not show multiple volume entries in the catalog until the additional volumes have been accessed.

Press Enter to display a list of all allocated volumes as shown in Figure 77.

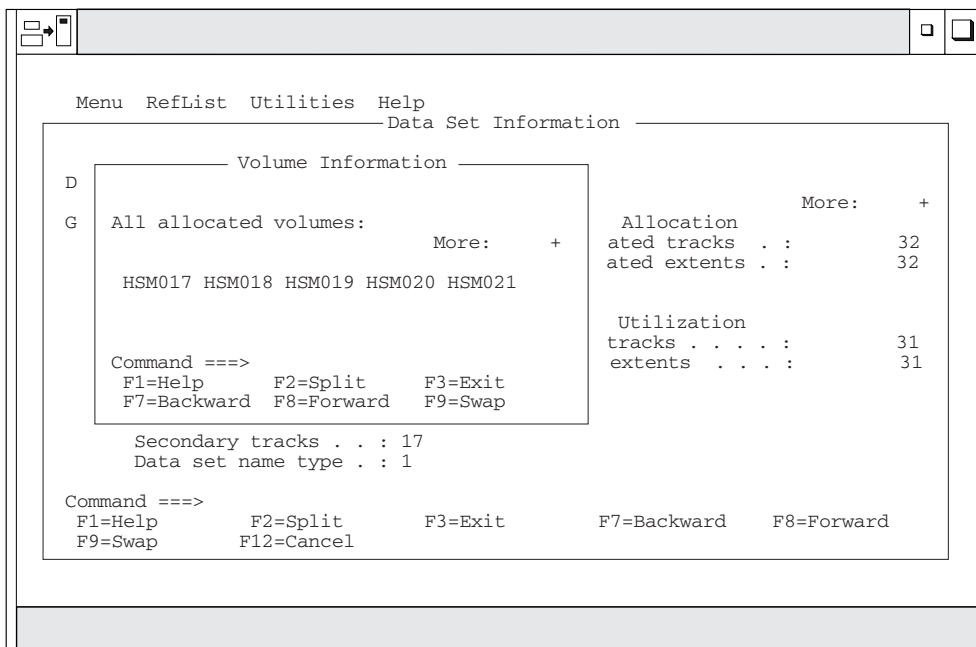

Figure 77. Volume Information for a Managed Multivolume Data Set (ISRUAMVI)

The major difference between this information and the information that is displayed for data sets on non-managed volumes is the addition of these classes:

- Management class
- Storage class
- Data class

S — short data set information

If you select option S, information about the selected data set is displayed. The information displayed by option S is the same as that displayed by option S of the Data Set utility (option 3.2), but it differs from option I in two respects.

Information for partitioned data sets, when displayed by option S, lacks the number of maximum and used directory blocks, and the number of members. For sequential data sets, options I and S display the same information. You can not enter a volume serial when you are requesting information on multivolume data sets.

Note:

1. The space for data sets allocated in blocks is calculated as if all of the tracks, including the last one, contain only full blocks of data. Any partial “short” blocks are ignored.
2. The information shown for current space utilization is the actual data that the data set contains, based on the number of allocation units (blocks, tracks, bytes, megabytes, and so on) that have been written. For a data set allocated in units other than tracks and cylinders, it does not include the unused portion of a track that is only partially filled.

For example, if a data set allocated in bytes with block size of 600 has one block written to a device with a track size of 1000, 600 bytes of data are written and the remaining 400 bytes cannot be used by a different data set. A track is the smallest possible unit of physical allocation to a data set on DASD. ISPF reports 600 bytes used while other products (such as ISMF) report 1000 bytes used. ISPF reports the space occupied by data in the data set. ISMF reports the space used by this data set that is not available for use by another data set. The difference is a relative indication of the effectiveness of the block size used when the data set was created.

Figure 78 shows a short format example of data set information for a partitioned data set. This is the short format ISPF uses to display data set information when DFSMSdftp is not installed or not available, or when the Storage Management Subsystem is not active. See “Short information for managed data sets” on page 110 to see how ISPF displays data set information when these products are installed, available, and active.

```

                                Data Set Information
                                More:      +
Data Set Name . . . . : MYPROJ.DEV.SOURCE

General Data                    Current Allocation
Management class . . . : STANDARD      Allocated cylinders : 1
Storage class . . . . : BASE           Allocated extents . : 1
Volume serial . . . . : MVS8WF
Device type . . . . . : 3390
Data class . . . . . : **None**        Current Utilization
Organization . . . . : PO              Used cylinders . . . : 1
Record format . . . . : FB             Used extents . . . . : 1
Record length . . . . : 80
Block size . . . . . : 27920
1st extent cylinders: 1
Secondary cylinders : 1
Data set name type : PDS

Creation date . . . . : 2002/07/08     Referenced date . . : 2002/07/31
Expiration date . . . : ***None***

Command ==>
F1=Help      F2=Split      F3=Exit      F7=Backward  F8=Forward  F9=Swap
F12=Cancel

```

Figure 78. Short data set information (ISRUAIP)

The “Allocated units” and “Used units” fields can vary, depending on the value that was specified in the “Space units” field when you allocated the data set. For example, Figure 78 shows what the short format of the Data Set Information panel would look like if the data set was allocated by specifying CYLS in the “Space units” field.

Library utility (option 3.1)

Short information for managed data sets: The Library Utility option S displays information (Figure 79) for data sets that reside on Storage Management Subsystem volumes (also called managed data sets) when:

- DFSMSdfp is installed and available
- Storage Management Subsystem is active.

```
Session A - [24x80]
File Edit Transfer Appearance Communication Assist Window Help
Data Set Information
Command ==> _____ More: +
Data Set Name . . . : P020136.PRIVATE.TABLES
General Data
Management class . . . : STANDARD
Storage class . . . : BASE
Volume serial . . . : PRM906
Device type . . . : 3390
Data class . . . : **NONE**
Organization . . . : PD
Record format . . . : FB
Record length . . . : 80
Block size . . . : 27920
1st extent tracks . : 10
Secondary tracks . : 10
Data set name type : LIBRARY
Current Allocation
Allocated tracks . : 17
Allocated extents . : 5
Current Utilization
Used pages . . . : 181
% Utilized . . . : 88
Creation date . . . : 1999/12/06
Expiration date . . : ***NONE***
Referenced date . . : 2000/02/04
F1=Help F2=Split F3=Exit F7=Backward F8=Forward F9=Swap
F12=Cancel
02/015
```

Figure 79. Data Set Information (Short) for Managed Data Sets (ISRUAISE)

The major difference between this information and the information that is displayed for data sets on non-managed volumes is the addition of these classes:

- Management class
- Storage class
- Data class

If the data set is a PDSE, the “Data set name type” field is LIBRARY. Because the used blocks and used extents are not applicable to a PDSE, the Data Set Information panel replaces these values with “Used pages” and “% Utilized” (Figure 80 on page 111). Other values that can appear in the “Data set name type” field are:

- HFS - MVS Hierarchical File System data set
- EXTENDED - DFSMSdfp Striped data set. When the Data Set Name Type is EXTENDED, the SMS Compressible field indicates if the data set is compressible or not (YES or NO).
- LARGE - Large format sequential data set

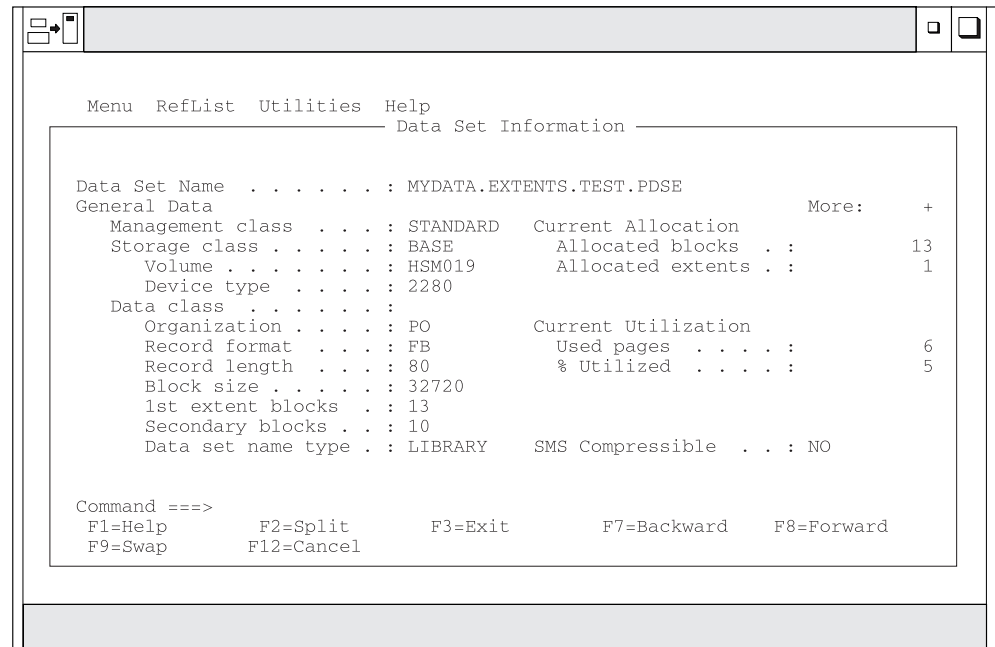

Figure 80. Data Set Information (Short) for a PDSE (ISRUAISE)

Library utility options for members

The topics listed here describe the options shown on the right side of the Library Utility panel shown in Figure 71 on page 102. These options are used to work with members.

- “B — browse member”
- “C — copy member” on page 112
- “D — delete members” on page 112
- “E — edit member” on page 112
- “G — reset member” on page 112
- “M — move member” on page 112
- “P — print member” on page 112
- “R — rename member” on page 112
- “T — TSO command for member” on page 113
- “V — view member” on page 113
- “W — WS command for member” on page 113

Note:

1. You can *chain* these commands; that is, you can select multiple members from a member list for various processing tasks. Use the CANCEL command (from a View, Browse, or Edit session) to break the chain and return to the member list.
2. With an enhanced member list, you can enter other commands. See “M — display member list” on page 165.

B — browse member

If you select option B, you must specify a partitioned data set and a member name. The specified member is displayed in Browse mode. You can use all the Browse commands. When you exit Browse, the Library Utility panel reappears.

Library utility (option 3.1)

C — copy member

If you select option C, the copy prompt panel appears where you must specify a partitioned data set and member name for the new member. When you exit Copy, the Library Utility panel reappears.

D — delete members

If you select option D, you must specify a partitioned data set and a member name or pattern. Option D prevents you from deleting a PDS member that any user is currently editing.

If you have selected Confirm Member Delete on the Library Utility panel (ISRUDA1), then you are asked to confirm your intention to delete this member. Note that Confirm Delete is forced on when deleting members by pattern.

Where the member to be deleted is the name of a primary member, the primary name and all associated alias names are deleted. Where the member is an alias member, only the alias name and its directory entry are deleted.

Where a member pattern has been specified, these rules apply:

- All primary members whose name matches the member pattern are deleted.
- All aliases that are associated with a primary member whose name matches the member pattern are deleted, even if the alias name itself does not match the member pattern.
- All aliases whose name matches the member pattern are deleted, even if the alias is associated with a primary member whose name does not match the member pattern.

E — edit member

If you select option E, you must specify a partitioned data set and member name. The specified member is displayed in Edit mode. You can use all EDIT commands. When you exit Edit, the Library Utility panel reappears.

G — reset member

If you select option G, the reset prompt panel displays, where you enter the data set and member name. When you exit, the Library Utility panel reappears.

M — move member

If you select option M, the move prompt panel displays, where you enter the data set and member name. When you exit, the Library Utility panel reappears.

P — print member

If you select option P, you must specify a partitioned data set and a member name. A source listing of the member is recorded in the ISPF list data set.

Note: If any members are to be printed, the data set characteristics must conform to those for the L option.

R — rename member

If you select option R, you must specify a partitioned data set and member name. You must also specify a new member name in the “New name” field. Option R prevents you from renaming a member that is currently being edited by you or another user.

Where the data set refers to a partitioned data set load library (RECFM=U), and the member to be renamed is the name of an primary member, the user data component of any associated alias names will be updated to refer to the renamed primary name.

T — TSO command for member

If you select option T, the TSO command prompt panel appears, where you can enter the TSO command to be run for the member.

V — view member

If you select option V, you must specify a partitioned data set and member name. The specified member is displayed in View mode. You can use all EDIT commands. When you exit View, the Library Utility panel reappears. For more information, see the topic about the View (option 1) in *z/OS ISPF User's Guide Vol I*.

W — WS command for member

If you select option W, the WS command prompt panel appears, where you can enter the WS command to be run for the member.

Data set utility (option 3.2)

When you select this option, a panel is displayed (Figure 81) that allows you to specify a data set and an action to be performed.

```

Menu  RefList  Utilities  Help
-----
                                Data Set Utility

  A Allocate new data set          C Catalog data set
  R Rename entire data set        U Uncatalog data set
  D Delete entire data set        S Short data set information
blank Data set information        V VSAM Utilities

ISPF Library:
Project . . . _____          Enter "/" to select option
Group  . . . _____          / Confirm Data Set Delete
Type  . . . . _____

Other Partitioned, Sequential or VSAM Data Set:
Data Set Name . . . _____
Volume Serial . . . _____ (If not cataloged, required for option "C")

Data Set Password . . _____ (If password protected)

Option ==>
F1=Help   F2=Split   F3=Exit   F7=Backward  F8=Forward  F9=Swap
F10=Actions F12=Cancel

```

Figure 81. Data Set Utility panel (ISRUDA2S)

Data Set Utility panel action bar

The Data Set Utility panel action bar choices function as follows:

Menu For more information, see the details about the Menu Action Bar Choice in the ISPF User Interface topic in the *z/OS ISPF User's Guide Vol I*.

RefList

For information about referral lists, see the topic about Using Personal Data Set Lists and Library Lists in the *z/OS ISPF User's Guide Vol I*.

Data set utility (option 3.2)

Utilities

For more information, see the details about the Utilities Action Bar Choice in the ISPF User Interface topic in the *z/OS ISPF User's Guide Vol I*.

Help The Help pull-down provides information on:

- allocating new partitioned and sequential data sets
- processing existing data sets (renaming, deleting, cataloging, uncataloging, and displaying data set information)
- The VSAM utilities

Data Set Utility panel fields

All the fields on the Data Set Utility panel are explained in the “ISPF Libraries and Data Sets” chapter of the *z/OS ISPF User's Guide Vol I*. For option A you can specify any DASD-resident sequential or partitioned data set. For the other options, you can specify any DASD-resident data set that is not VSAM. You can get short information on a VSAM data set.

Data set utility options

These topics describe the options shown on the Data Set Utility panel:

- “A — allocate new data set”
- “Allocation errors” on page 121
- “C — catalog data set” on page 122
- “R — rename entire data set” on page 123
- “U — uncatalog data set” on page 124
- “D — delete entire data set” on page 124
- “S — data set information (short)” on page 127
- “Blank — (data set information)” on page 127
- “V — VSAM utilities” on page 128

A — allocate new data set

Use option A to allocate a new data set with or without the Storage Management Subsystem classes (management class, storage class, and data class). A data set that is allocated on a volume that is managed by the Storage Management Subsystem (SMS) is called a *managed* data set. A data set that is allocated on a volume that is not managed by the SMS is called a *non-managed* data set.

To use option A, you must:

1. Enter one of these:
 - An ISPF library name in the Project, Group, and Type fields
 - Another partitioned or sequential data set name in the Data Set Name field.
See the “ISPF Libraries and Data Sets” chapter of the *z/OS ISPF User's Guide Vol I* for information on how to enter the ISPF library name or the data set name.
2. If you entered an ISPF library name, the value in the Volume Serial field is ignored. However, if you entered another data set name, you can specify the volume on which to allocate the data set in the Volume Serial field. Do not enter a volume serial if you want to do one of these:
 - Use the authorized default volume.
 - Enter a generic unit address in the “Generic unit” field on the Allocate New Data Set panel.

Note that an SMS-eligible data set may be allocated on a volume different from any entered value.

For more information about Volume Serials, see the "ISPF Libraries and Data Sets" chapter of the *z/OS ISPF User's Guide Vol I*.

3. If your ISPF libraries and data sets are password-protected, enter the password in the Data Set Password field.

For more information about Data Set Passwords, see the "ISPF Libraries and Data Sets" chapter of the *z/OS ISPF User's Guide Vol I*.

Note: You cannot assign a password to a managed data set. Therefore, the Data Set Password field is ignored when you allocate a managed data set.

4. Press Enter.

The Allocate New Data Set panel is displayed. This panel enables you to specify data set allocation values. The fields displayed on this panel depend upon the value of the ALLOWED_ALLOCATION_UNITS keyword in the ISPF configuration table. When ALLOWED_ALLOCATION_UNITS is not 'A' the panel shown in Figure 82 is displayed.

```

Menu  RefList  Utilities  Help
-----
                          Allocate New Data Set
Data Set Name . . . . : HANKO.TEST.DATADEV                               More:  +
Management class . . . PRIMARY                                         (Blank for default management class)
Storage class . . . . PRIMARY                                          (Blank for default storage class)
Volume serial . . . . A$US20                                          (Blank for system default volume) **
Data class . . . . .                                                  (Blank for default data class)
Space units . . . . . CYLINDER                                         (BLKS, TRKS, CYLS, KB, MB, BYTES
or RECORDS)
Average record unit . . . . .                                         (M, K, or U)
Primary quantity . . . 1____                                          (In above units)
Secondary quantity . . . 20____                                       (In above units)
Directory blocks . . . 0____                                          (Zero for sequential data set) *
Record format . . . . FB____
Record length . . . . 80____
Block size . . . . . 27920____
Data set name type . . . . .                                         (LIBRARY, HFS, PDS, LARGE, BASIC, *
EXTREQ, EXTPREF or blank)
Data set version . . . -____
Extended Attributes . . . ____                                         (NO, OPT or blank)
Expiration date . . . . ____                                         (YY/MM/DD, YYYY/MM/DD
MM.DDD, MMMM.DDD in Julian form)
Command ==>>>
F1=Help      F2=Split      F3=Exit      F7=Backward  F8=Forward  F9=Swap
F10=Actions  F12=Cancel

```

Figure 82. Allocate New Data Set panel (ISRUAAP2)

Otherwise, this panel is displayed: (Figure 83 on page 116).

Data set utility (option 3.2)

```
Menu RefList Utilities Help
-----
Allocate New Data Set
More: +
Data Set Name . . . : MYPROJ.DEV.SOURCE2
Management class . . . STANDARD (Blank for default management class)
Storage class . . . . . BASE (Blank for default storage class)
Volume serial . . . . . MVS8WF (Blank for system default volume) **
Device type . . . . . (Generic unit or device address) **
Data class . . . . . (Blank for default data class)
Space units . . . . . CYLINDER (BLKS, TRKS, CYLS, KB, MB, BYTES
or RECORDS)
Average record unit (M, K, or U)
Primary quantity . . 1 (In above units)
Secondary quantity 1 (In above units)
Directory blocks . . 0 (Zero for sequential data set) *
Record format . . . . FB
Record length . . . . 80
Block size . . . . .
Data set name type . PDS (LIBRARY, HFS, PDS, LARGE, BASIC, *
EXTREQ, EXTPREF or blank)
Data set version . . -
Extended Attributes (NO, OPT or blank)
Command ==>
F1=Help F2=Split F3=Exit F7=Backward F8=Forward F9=Swap
F10=Actions F12=Cancel
```

Figure 83. Allocate New Data Set —managed data set support panel (ISRUAASE)

When you press Enter with this panel displayed, the new data set is allocated and cataloged. Entering the END command returns you to the previous panel without allocating the data set.

An optional installation exit, the data set allocation exit, can control all data set creation, deletion, allocation, and deactivation done directly by ISPF. This does not include allocations done by ISPF, the TSO ALLOCATE command, or other TSO commands. See *z/OS ISPF Planning and Customizing* for more information about the data set allocation exit.

Your installation must use DFSMSdftp to define the values that you enter in the “Management class”, “Storage class”, and “Data class” fields. If you have no specific requirements, you can leave these fields blank. However, be aware that your installation may provide default management, storage, and data classes. These defaults would take effect if you leave any of the class fields blank and may even override any classes that you specify.

Management class

Used to obtain data management-related information (migration, backup, and retention criteria, such as expiration date) for the data set allocation.

If you have no specific management class requirements, you can leave this field blank. However, be aware that your installation may provide a default management class. This default may even override any management class that you specify.

Storage class

Used to obtain the storage-related information (volume serial) for the data set allocation. Any volume serial that you enter in the “Volume serial”

field is ignored unless the storage class that you use includes the Guaranteed Space=Yes attribute (useful if you are allocating multivolume data sets).

Data class

Used to obtain the data-related information (space units, primary quantity, secondary quantity, directory block, record format, record length, and data set name type) for the allocation of the data set.

Default values are provided for the fields in Figure 82 on page 115, except for expiration date, based on which of these occurred most recently:

- What you last entered on this panel
- The last display data set information request (options 3.1, 3.2, or 3.4).

You can type over the displayed defaults if you want to change them. Here is a list of the fields on this panel and their definitions:

Volume serial

This field is one that you probably will not need to use very often. It is not required and is usually ignored by the Storage Management Subsystem. Do not enter a volume serial if you want to do one of these:

- Use the authorized default volume.
- Enter a generic unit address in the Generic unit field.
- Use the volume specified by the storage class you are using.

When a storage class is used, your installation and the SMS assume joint responsibility for determining the volume on which the data set is allocated. The SMS enables the installation to select the volumes that are eligible to contain the data set. It then chooses one of those volumes and allocates the data set. The SMS's volume choice is based on:

- storage requirements
- The amount of space a volume has available.

Note: ISPF does not support allocation of tape data sets.

Generic unit

The generic unit address for the direct access volume that is to contain the data set, such as 3380 or 3390. This field overrides the Volume Serial field on the Data Set Utility panel. Therefore, you should leave this field blank if you want to do one of these:

- Use the authorized default volume
- Enter a volume serial in the Volume serial field.

Note:

1. Leave both the Volume serial and Generic unit fields blank to allow ISPF to select an eligible volume. Eligibility is determined by the unit information in your user entry in the TSO User Attribute Data Set (UADS) or the TSO segment of RACF.
2. At some installations, you are limited to eligible volumes even when an explicit volume serial is specified. At other installations you can specify any mounted volume. This is an installation option.
3. To allocate a data set to a 3850 virtual volume, you must also have MOUNT authority, gained by using the TSO ACCOUNT command or by using the RACF PERMIT command for the TSO AUTH general resource class.

Data set utility (option 3.2)

4. If you are allocating an SMS data set, you can enter either an installation defined group name or a generic device type in the Generic unit field, but not a specific device number.

Space units

Any of these:

Track Shows that the amounts entered in the primary and secondary quantity fields are expressed in tracks.

Cylinder

Shows that the amounts entered in the primary and secondary quantity fields are expressed in cylinders.

Block Shows that the amounts entered in the primary and secondary quantity fields are expressed in blocks.

Megabyte

Shows that the amounts entered in the primary and secondary quantity fields are expressed in megabytes.

Kilobyte

Shows that the amounts entered in the primary and secondary quantity fields are expressed in kilobytes.

Byte Shows that the amounts entered in the primary and secondary quantity fields are expressed in bytes.

Records

Shows that the amounts entered in the primary and secondary quantity fields are the average number of records of the size specified by the block size field.

Note: "Space units" allows the shortest unique abbreviation for each attribute; for example, T for TRKS, C for CYLS, K for KB, and M for MB, BY for BYTE, R for RECORDS, and BL for BLKS.

Average record unit

Shows the unit used when allocating average record length. U specifies single-record units (bytes). K specifies thousand-record units (kilobytes). M specifies million-record units (megabytes). The default value is U.

Primary quantity

The primary allocation quantity in tracks, cylinders, blocks, megabytes, kilobytes, bytes, or records, as shown in the "Space units" field. This number can be zero for sequential data sets, but must be greater than zero for PDSs. Also, if the primary quantity is zero, the secondary quantity must be greater than zero.

Secondary quantity

The secondary allocation quantity in tracks, cylinders, blocks, megabytes, kilobytes, bytes, or records, as shown in the "Space units" field. This quantity is allocated when the primary quantity is insufficient.

Directory blocks

Enter one of these:

- For partitioned data sets, you must specify the number of directory blocks. Each 256-byte block accommodates these number of directory entries:
 - Data sets with ISPF statistics: 6
 - Data sets without ISPF statistics: 21
 - Load module data sets: 4-7, depending on attributes

- ISPF requests a data set organization (DSORG) of PS when the value is zero or PO if the value is greater than zero. Note that ISPF converts a blank value to zero.

Record format

Any valid combination of these codes:

- F** Fixed-length records.
- V** Variable-length records.
- U** Undefined format records.
- B** Blocked records.
- A** ASA printer control characters.
- M** Machine code printer control characters.
- S** Standard (for F) or spanned (for V); use only with sequential data sets.
- T** Track-overflow feature.

Note:

1. You must enter either F, V, or U.
2. You can specify S and T, but ISPF does not otherwise support them.

Record length

The logical record length, in bytes, of the records to be stored in the data set.

Block size

The block size, also called *physical record length*, of the blocks to be stored in the data set. Use this field to specify how many bytes of data to put into each block, based on the record length. For example, if the record length is 80 and the block size is 3120, 39 records can be placed in each block.

Note: The record length and block size are verified to be consistent with the record format. If you need to use non-standard characteristics, use the TSO ALLOCATE command.

Data set name type

The type of data set to be allocated:

LIBRARY

Allocates a partitioned data set extended.

HFS Allocates an HFS PDSE. This is valid for DFSMS 1.2 only.

PDS Allocates a partitioned data set.

LARGE

Allocates a large format sequential data set.

EXTREQ

Indicates that an extended data set is required.

EXTPREF

Indicates that an extended data set is preferred.

BASIC

Indicates that neither an extended nor a large format sequential data set is to be allocated.

blank Allocates a partitioned or sequential data set based on the data set characteristics entered.

Note: If you specify LIBRARY and a zero directory size, ISPF allocates a PDSE and overrides the zero directory size. If you specify blanks for the directory size, a sequential data set is allocated instead of a PDSE.

Data set utility (option 3.2)

Data set version

The version number when the Data set name type is LIBRARY. Valid values are:

1 Library version 1

2 Library version 2

blank ISPF does not specify the library version and this is determined by system defaults.

Extended Attributes

Valid values are:

NO Data set cannot have extended attributes or reside in EAS. This is the default for non-VSAM data sets.

OPT Data set can have extended attributes and reside in EAS. This is the default for VSAM data sets.

blank Use default based on data type.

Expiration date

Allows you to protect valuable data by specifying a date, in your national language, when the data set may be deleted. If you try to delete an unexpired data set, ISPF displays two panels: a Confirm Delete panel, followed by a Confirm Purge panel. See "D — delete entire data set" on page 124 for more information about deleting unexpired data sets.

An expiration date is not required, but if you enter one it should be in one of these formats:

YYYY/MM/DD

Date shown in year, month, and day, or your equivalent national format. The maximum expiration date allowed is 2155/12/31.

YYYY.DDD

Date shown in Julian format, such as 2006.066 for March 7, 2006. The maximum expiration date allowed is 2155.365.

You can specify a DDD value of up to 366 if the YYYY value represents a leap year.

DDDD

The number of days, starting with the creation date, after which the data set can be deleted. DDDD has a range of 0 to 9999.

PERM, NOLIMIT, NEVER, 9999

Specifying any of these values causes ISPF to translate it to a value of 9999.365. This is treated by ISPF as permanent retention.

Allocate Multiple Volumes

Allows you to allocate sequential data sets that span multiple volumes. ISPF supports a maximum of 59 volumes. Place a slash in this field and press Enter to display a panel similar to the one shown in Figure 84 on page 121.

```

Menu  RefList  Utilities  Help
-----
Multivolume Allocation
-----
ISRUAMV

Enter the number of volumes to allocate or
the names of one or more volumes and
press Enter to allocate or enter Cancel
command to exit.  If a number is entered,
any volume names will be ignored.

Number of volumes to allocate:  ___

Volume names:
1. MVS8WF  2.  _____  3.  _____  4.  _____
Command ==>>

F1=Help      F2=Split      F3=Exit
F7=Backward  F8=Forward    F9=Swap

Enter "/" to select option          DDDD for retention period in days
/ Allocate Multiple Volumes        or blank)

Command ==>>
F1=Help      F2=Split      F3=Exit      F7=Backward  F8=Forward    F9=Swap
F10=Actions  F12=Cancel

More:  - +
device address) **
lt data class)
S, KB, MB, BYTES

tial data set) *

DS, or blank) *
MM/DD
D in Julian form

```

Figure 84. Multivolume allocation panel (ISRUAMV)

This panel allows you to specify up to 59 volumes.

Note:

- Although the volume input fields are numbered consecutively, you may enter volume names in any of the fields.
- The volume that you enter in the "Volume serial" field on the Allocate New Data Set panel will be placed in the first field of the Multivolume Allocation panel.
- If you enter only one volume, standard data set allocation is invoked.
- If you enter a number in the "Number of volumes to allocate" field, any volume names left in the name fields are ignored, and might or might not be the volumes the data set is allocated to.
- When displaying information about a multivolume data set, depending on your system setup, all volumes might not be shown until they have been accessed.

Allocation errors

ISPF attempts to recognize inconsistent attributes for partitioned and sequential data sets before allocating them. However, when conditions outside ISPF's control result in the allocation of such a data set, the Allocation Error panel (Figure 85 on page 122) is displayed. These conditions are caused by:

- A data class that specifies inconsistent attributes
- Attributes entered on the Allocate New Data Set panel that create inconsistency by overriding other attributes specified by the data class.

Data set utility (option 3.2)

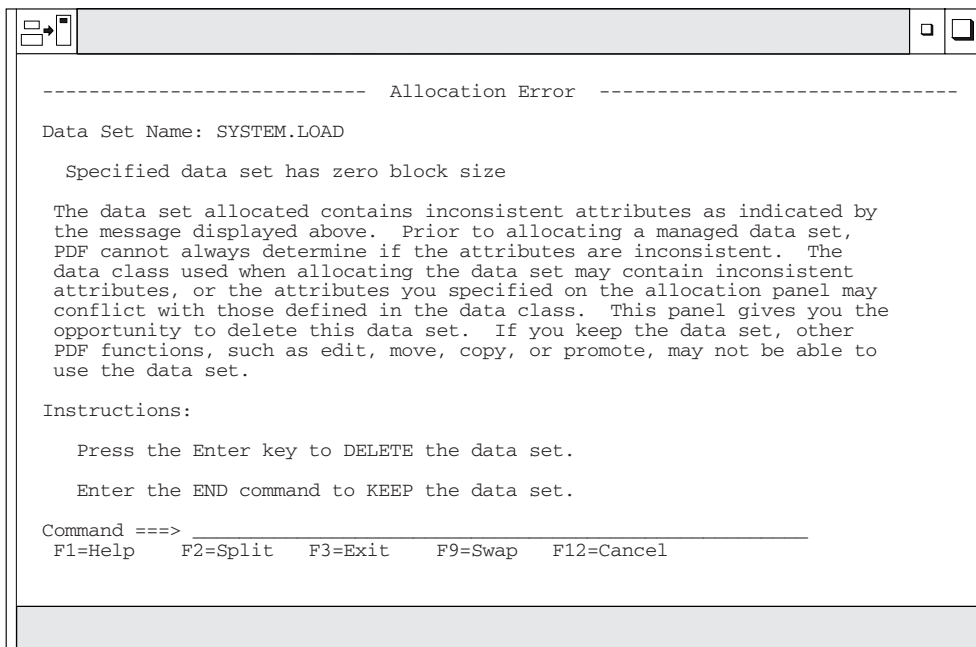

Figure 85. Allocation Error Panel (ISRUADCS)

The term *inconsistent attributes* refers to incompatible values that have been specified for one or more of these items: Space units; Primary or Secondary quantity; Directory blocks; Record format; Record length; Block size.

For example, if you allocate a data set with an undefined record format (RECFM=U) and a block size of zero (BLOCKSIZE=0), some ISPF functions (such as Move and Copy) and services (such as LMMOVE, LMCOPY, and LMINIT) cannot use the data set.

However, when either the linkage editor or the IEBCOPY utility has been called, these functions and services determine the best block size for the data set. Then, when the data set has a block size greater than zero, the ISPF functions and services listed can be used.

The Allocation Error panel gives you the opportunity to delete such a data set because other ISPF functions, such as View (option 1) and Edit (option 2), may not be able to use it.

For information about allocation errors and how they affect data set promotion when using SCLM, refer to *z/OS ISPF Software Configuration and Library Manager Guide and Reference*.

C — catalog data set

If you select option C, the specified data set is cataloged. For this option, you must specify the volume serial on which the data set resides, regardless of whether the data set is specified as project, library, and type, or as another data set name. The data set must reside on the specified volume.

The preceding instructions for cataloging data sets do not apply to data sets that reside on Storage Management Subsystem volumes. These data sets are automatically cataloged when you allocate them. They cannot be cataloged by using option C.

R — rename entire data set

If you select option R, a panel is displayed to allow you to enter the new data set name.

Type the new data set name and press Enter to rename, or enter the END command to cancel. Either action returns you to the previous panel.

If you specify a volume serial for a data set to be renamed, ISPF checks to see whether the data set is cataloged on that volume. If it is, the Rename panel prompts you to specify whether to recatalog the data set. If you specify a volume serial and the data set is not cataloged, it remains uncataloged after you rename it. If a volume serial is not specified, the data set is recataloged to the new data set name and the old data set name is uncataloged.

Note:

1. ISPF does not rename VSAM data sets or password-protected data sets.
2. A volume serial is not allowed for multivolume data sets using Rename.
3. Generation Data Group (GDG) data sets can only be renamed to something other than GDG names.

Attention: Trying to rename GDG data sets to a different generation or version number can cause deletion of your GDG data set or group of GDG data sets.

4. When you rename a data set that resides on a Storage Management Subsystem volume, you cannot specify a volume serial in the Volume Serial field. Both the cataloged entry and the VTOC entry are renamed.

Rename processing with RACF: The normal order of processing when ISPF is asked to rename a data set is as follows:

1. The new data set name is cataloged using SVC 26
2. The data set is renamed using SVC 30
3. The old data set name is uncataloged using SVC 26

There are three occasions, however, when ISPF will deviate from this order of processing:

- If the data set is a System Managed (SMS) data set, the update of the catalog (both cataloging the new name and uncataloging the old name) is handled by the operating system when the SVC 30 is issued. In this case, ISPF does not issue either of the SVC 26 requests.
- If the data set is an uncataloged data set, no catalog update will be done. The data set is renamed using the SVC 30 only.
- If the data set is cataloged, but the user specified both the data set name and volume, panel ISRUARP2 is displayed. The user has the option of specifying whether the catalog processing should be done. If the user indicates (via a NO in the "Reply to uncatalog the data set" field) that no catalog processing should be done, only the SVC 30 is used to rename the data set. If the reply is YES, the SVC 30 as well as both SVC 26 requests are issued.

If an error is encountered during a rename request, an attempt is made to return the data set to its original name, and to reset the catalog entries to their original status (remove the new name from the catalog and leave the old name in the catalog).

This order of processing is intended to minimize the possibility that an uncataloged data set will result if an error is encountered during the rename

Data set utility (option 3.2)

process. Errors may be encountered due to certain combinations of RACF data set profiles and user access to the groups under which those data set profiles fall. When an error occurs, the user receives a message indicating the status of the data set name, and of the catalog entries.

See the *z/OS Security Server RACF Security Administrator's Guide* or equivalent documentation for your security package, to determine the authorization levels required for each of these operations. The user will need authorization first to catalog the new data set name, then to rename the data set, and then to uncatalog the old data set name. This will require adequate authorization to any discrete or generic data set profiles involved and to the catalogs involved. Be aware that a discrete data set profile is renamed when the data set is renamed.

Renaming with expiration dates: If the data set has an expiration date in its catalog entry, the expiration date is not propagated forward to the new catalog entry. In this case, a confirmation panel is displayed.

As directed by the panel, press Enter if you want to confirm the rename request. If you want the data set to have an expiration date under its new name, use the TSO ALTER command or a similar function to update the new catalog entry.

Renaming with aliases: The results of renaming a data set with an alias differ depending upon whether the data set is on a System Managed Storage (SMS) volume or not. For an SMS data set, DFSMS ensures the alias is preserved and is associated with the new data set name. For a non-SMS data set, the alias is removed.

U — uncatalog data set

If you select option U, the specified data set name is uncataloged. There is no need for the specified data set to be allocated or for the volume on which it resides to be mounted.

If the catalog entry being removed contains an expiration date in the future, a confirmation panel is displayed. Press Enter if you want to confirm the uncatalog request, otherwise press END to cancel the request.

Note: Uncatalog is not allowed for multivolume data sets.

You cannot use option U to uncatalog a data set that resides on a Storage Management Subsystem volume. However, the system uncatalogs these data sets when you delete them, which is done by using option D of either the Data Set utility (option 3.2) or the Data Set List utility (option 3.4).

D — delete entire data set

If you select option D, a confirmation panel is displayed (Figure 86 on page 125) so you can make sure you did not select this option by mistake.

```

Menu  RefList  Utilities  Help
-----
                                Confirm Delete
                                More:      +
Data Set Name . : MYPROJ.DEV.SOURCE
Volume . . . . : MVS8WF
Creation date . : 2002/07/08
b
Enter "/" to select option
I  _ Set data set delete confirmation off
Instructions:
  Press ENTER to confirm delete.
  (The data set will be deleted and uncataloged.)
O
  Press CANCEL or EXIT to cancel delete.
Command ==>
D  F1=Help   F2=Split   F3=Exit    F7=Backward F8=Forward
   F9=Swap   F12=Cancel
Option ==> D
F1=Help   F2=Split   F3=Exit    F7=Backward F8=Forward   F9=Swap
F10=Actions F12=Cancel

```

Figure 86. Confirm Delete panel (ISRUADC1)

If you specify a volume serial for the data set to be deleted, ISPF checks to see whether the data set is cataloged on that volume. If so, the Confirm Delete panel prompts you to specify whether to uncatalog the data set. The displayed default is YES. If no volume serial is specified, and the data set does not have an expiration date, the data set is deleted and uncataloged.

Note:

1. ISPF does not delete password-protected data sets or data sets allocated with an esoteric device type.
2. A volume serial is not allowed for multivolume data sets using Delete.

As directed on the panel, perform one of these actions:

- Press Enter to confirm the data set deletion.
- Enter the CANCEL or EXIT command to cancel. This action returns you to the previous panel.

If the data set has an expiration date that has not expired, ISPF displays a Confirm Purge panel (Figure 87 on page 126) after the Confirm Delete panel.

Data set utility (option 3.2)

```
Menu RefList Utilities Help
-----
Confirm Delete

Data Set being deleted has an expiration date which has not expired
Data Set Name . : MYPROJ.DEV.SOURCE
Volume . . . . : MVS8WF
b Creation date . : 2002/07/08
Expiration Date : 2002/10/01
I
Enter "/" to select option
_ Purge Data Set

Instructions:
O Enter "/" to confirm the purge request.
(The data set will be deleted and uncataloged.)

Press CANCEL or EXIT to cancel the purge request.

Command ===>
D F1=Help F2=Split F3=Exit F7=Backward F8=Forward
F9=Swap F12=Cancel

F10=Actions F12=Cancel
```

Figure 87. Confirm purge panel (ISRUADC3)

Use a slash to select Purge Data Set if you want ISPF to purge the data set. The statement that is enclosed in parentheses on the Confirm Purge panel shows whether the data set to be purged will be uncataloged.

When you delete a data set, the volume name is compared to the volume name in the configuration table. If the names match, the command specified in the configuration table is used in place of the ISPF delete processing. This lets you delete migrated data sets without first causing them to be recalled.

Delete processing with RACF: If the data set is an SMS data set, it is deleted using SVC 29. The update of the catalog entry is handled by the operating system.

If the data set is not an SMS data set and either it is not cataloged or the user indicates on panel ISRUADC2 (panel ISRUADC2 is shown if the volume is supplied) that it is not to be uncataloged, it is deleted using SVC 29.

If the data set is not an SMS data set and it is cataloged and/or the user indicates on panel ISRUADC2 (panel ISRUADC2 is shown if the volume is supplied) that it is to be uncataloged, this process is followed:

1. The data set is deleted using SVC 29 (SCRATCH).
2. The data set is uncataloged using SVC 26.

This order of processing is intended to minimize the possibility that an uncataloged data set will result if an error is encountered during the delete process. Some combinations of RACF generic and discrete data set profiles and user access to the groups under which those profiles fall can cause this process to fail. If an error is encountered in this process the user is notified via a message of the status of the data set and catalog entries.

See the *z/OS Security Server RACF Security Administrator's Guide* or equivalent documentation for your security package, to determine the authorization levels required for each of these operations. The user will need authorization first to

delete the data set and then to uncatalog the data set name. This will require adequate authorization to any discrete or generic data set profiles involved and to the catalogs involved. Be aware that a discrete data set profile is deleted when the data set is deleted.

S — data set information (short)

If you select option S, information about the selected data set is displayed. The information displayed by option S is the same information displayed by option S on the Library Utility panel (option 3.1). See “S — short data set information” on page 108 for more information and Figure 78 on page 109 for an example. To return to the previous panel, press Enter or enter the END command.

The space for data sets allocated in blocks is calculated as if all of the tracks, including the last one, contain only full blocks of data. Any partial “short” blocks are ignored.

Note:

1. The information shown for current space utilization is the actual data that the data set contains, based on the number of allocation units (blocks, tracks, bytes, megabytes, and so on) that have been written. For a data set allocated in units other than tracks and cylinders, it does not include the unused portion of a track that is only partially filled.

For example, if a data set allocated in bytes with block size of 600 has one block written to a device with a track size of 1000, 600 bytes of data are written and the remaining 400 bytes cannot be used by a different data set. A track is the smallest possible unit of physical allocation to a data set on DASD. ISPF reports 600 bytes used while other products (such as ISMF) report 1000 bytes used. ISPF reports the space occupied by data in the data set. ISMF reports the space used by this data set that is not available for use by another data set. The difference is a relative indication of the effectiveness of the block size used when the data set was created.

2. Space utilization values are not displayed for VSAM or BDAM data sets.

See “Short information for managed data sets” on page 110 to learn more about the data set information that is displayed for managed data sets.

Blank — (data set information)

If you leave the Option field blank, information about the selected data set is displayed. The information displayed is the same information displayed by option I on the Library Utility panel (option 3.1). See “I — data set information” on page 104 for more information and “U — uncatalog data set” on page 124 for an example. To return to the previous panel, press Enter or enter the END command.

Note:

1. For multivolume data sets, options I and S display current allocation and utilization values that represent totals from all volumes used.
2. You can not enter a volume serial when you are requesting information on a multivolume data set.
3. The space for data sets allocated in blocks is calculated as if all of the tracks, including the last one, contain only full blocks of data. Any partial “short” blocks are ignored.
4. The information shown for current space utilization is the actual data that the data set contains, based on the number of allocation units (blocks, tracks, bytes,

Data set utility (option 3.2)

megabytes, and so on) that have been written. For a data set allocated in units other than tracks and cylinders, it does not include the unused portion of a track that is only partially filled.

For example, if a data set allocated in bytes with block size of 600 has one block written to a device with a track size of 1000, 600 bytes of data are written and the remaining 400 bytes cannot be used by a different data set. A track is the smallest possible unit of physical allocation to a data set on DASD. ISPF reports 600 bytes used while other products (such as ISMF) report 1000 bytes used. ISPF reports the space occupied by data in the data set. ISMF reports the space used by this data set that is not available for use by another data set. The difference is a relative indication of the effectiveness of the block size used when the data set was created.

5. Space utilization values are not displayed for VSAM or BDAM data sets.

See “Information for managed data sets” on page 107 for information about the data set information that is displayed for managed data sets.

V — VSAM utilities

Use option V to create the IDCAMS commands to define, delete, and list catalog information for VSAM data sets. Before the command is issued, you will be allowed to edit it in an ISPF Edit session. The command will process in the foreground.

Note: The VSAM utilities function builds a command that is syntactically correct; the utility does not do any compatibility checking of the fields used to build the command.

When you select option V, the panel shown in Figure 88 is displayed.

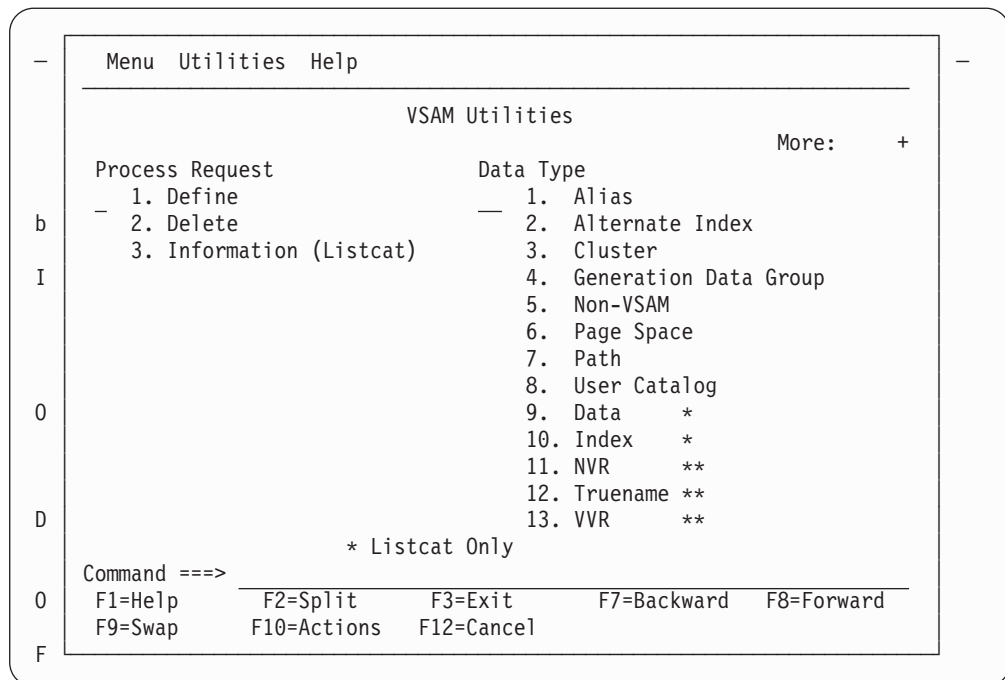

Figure 88. VSAM Utilities panel (ISRUVSAM)

VSAM Utilities panel action bar: The VSAM Utilities panel action bar choices function as follows:

Menu For more information, see the details about the Menu Action Bar Choice in the ISPF User Interface topic in the *z/OS ISPF User's Guide Vol I*.

Utilities

For more information, see the details about the Utilities Action Bar Choice in the ISPF User Interface topic in the *z/OS ISPF User's Guide Vol I*.

Help The Help pull-down provides information on the VSAM utilities, including the VSAM profile data set and the GET, SAVE, and CHANGE commands.

VSAM Utilities panel fields: There are two fields on the VSAM Utilities panel:

Process Request

Required field. Indicates what is going to be done to the VSAM data set:

- 1 **Define.** Process an IDCAMS define request
- 2 **Delete.** Process an IDCAMS delete request against one or more data sets.
- 3 **Listcat.** Process an IDCAMS list catalog request.

VSAM Data Type

Required field. Indicates what kind of data set is to be defined, deleted or listed:

- 1 **Alias.** Define, delete, or list an alternate name for a non-VSAM data set or a user catalog
- 2 **Alternate Index.** Specify that an alternate index is to be defined, deleted, or listed or that an alternate index entry is to be recataloged
- 3 **Cluster.** Specify that a cluster is to be defined, deleted, or listed or that a cluster entry is to be recataloged
- 4 **Generation Data Group.** Specify that a generation data group entry is to be defined, deleted, or listed
- 5 **Non-Vsam.** Specify that a non-VSAM, non-SMS-managed data set is to be defined, deleted, or listed
- 6 **Page Space.** Specify that a page space is to be defined, deleted, or listed
- 7 **Path.** Specify that a path is to be defined, deleted, or listed or that a path entry is to be recataloged
- 8 **User Catalog.** Specify that a catalog is to be defined, deleted, or listed
- 9 **Data.** List data level information (Listcat request only)
- 10 **Index.** List index level information (Listcat request only)
- 11 **NVR.** Delete an SMS-managed non-VSAM volume record entry (Delete request only)
- 12 **Truename.** Delete the truename entry for a data or index component of a cluster or alternate index or the name of an alternate index (Delete request only)
- 13 **VVR.** Delete an unrelated VSAM volume record entry (Delete request only).

Data set utility (option 3.2)

Example usage – defining a cluster: To define a cluster, on the VSAM Utilities panel, type 1 in the Process Request field and 3 in the VSAM Data Type field. The Define Cluster panel is displayed as shown in Figure 89.

```
Menu  Function  Utilities  Help
-----
                          Define Cluster
                          Enter "/" to select option
                          /  Edit IDCAMS command
                          /  Browse errors only

Cluster Name . . . MYPROJ.DEV.SOURCE3
More:      +

                          Cluster Level Information:

Space Units . . . . . - 1. Cylinders  Primary Quantity . . . _____
                          2. Tracks    Secondary Quantity . . _____
                          3. Records
                          4. Kilobytes
                          5. Megabytes

Volumes . . . . . _____ . . . . _____ . . . . _____
Buffer Space . . . . . _____
Control Interval Size . . _____
Data Class . . . . . _____
Management Class . . . . . _____
Command ==>
F1=Help      F2=Split    F3=Exit      F7=Backward  F8=Forward  F9=Swap
F10=Actions  F12=Cancel
```

Figure 89. Define Cluster panel (ISRUVPC3)

Note:

1. Select the Edit IDCAMS command option to edit the IDCAMS command that this process generates before the command is issued. If you do not select this option, the command will be issued when you press Enter.
2. Select the Browse errors only option to browse the output from IDCAMS only when a nonzero return code is returned by IDCAMS.

Fill in the required fields or use a VSAM profile data set as described in “Building a VSAM profile data set” on page 131. When you press Enter, the screen shown in Figure 90 on page 131 is displayed.

Note: If you try to use a profile that was defined for a different request type (for example, Generation Data Group), you will receive a “Type mismatch” error.

```

Menu Utilities Help
Columns 00001 00072

Instructions:

Enter EXECute command to issue request.

Enter CANcel, END, or RETURN command to cancel request.
***** ***** Top of Data *****
==MSG> -Warning- The UNDO command is not available until you change
==MSG> your edit profile using the command RECOVERY ON.
000001 /* IDCAMS COMMAND */
000002 DEFINE CLUSTER (NAME(MYPROJ.DEV.SOURCE3) -
000003 ) -
000004 DATA (NAME(MYPROJ.DEV.SOURCE3.DATA) -
000005 ) -
000006 INDEX (NAME(MYPROJ.DEV.SOURCE3.INDEX) -
000007 )
***** ***** Bottom of Data *****

Command ==> Scroll ==> PAGE
F1=Help F2=Split F3=Exit F5=Rfind F6=Rchange F7=Up
F8=Down F9=Swap F10=Left F11=Right F12=Cancel

```

Figure 90. Editing the IDCAMS command (ISRUVEDT)

When you are ready to process the command, type EXEC on the Command line and press Enter. If the command processes with a nonzero return code, the panel shown in Figure 91 is displayed.

```

VSAM Utilities ----- LINE 00000000 COL 001 080
***** ***** Top of Data *****
IDCAMS SYSTEM SERVICES TIME: 14:49:0

/* IDCAMS COMMAND */
DEFINE CLUSTER (NAME(USERID.PRIVATE.PANELS) -
CYLINDERS(4 1) -
VOLUMES(111111 -
) -
) -
DATA (NAME(USERID.PRIVATE.PANELS.DATA) -
) -
INDEX (NAME(USERID.PRIVATE.PANELS.INDEX) -
)
IDC3013I DUPLICATE DATA SET NAME
IDC3009I ** VSAM CATALOG RETURN CODE IS 8 - REASON CODE IS IGG0CLEH-38
IDC3003I FUNCTION TERMINATED. CONDITION CODE IS 12

IDC0002I IDCAMS 12
***** ***** IDCAMS has returned a non-zero return code. *****

COMMAND ==> SCROLL ==> PAGE
F1=Help F2=Split F3=Exit F5=Rfind F7=Up F8=Down F9=Swap
F10=Left F11=Right F12=Cancel

```

Figure 91. Browsing IDCAMS Errors (ISRUVBRO)

Press Exit (F3) to return to the panel shown in Figure 90, make the necessary changes, and resubmit the command.

Building a VSAM profile data set: You can build a VSAM profile data set, each member of which can be used to store input fields on a VSAM input panel for

Data set utility (option 3.2)

later retrieval to the same panel. If you try to use a profile that was defined for a different request type (for example, Generation Data Group), you will receive a "Type mismatch" error.

When you have filled in a VSAM input panel, select the Save to Profile choice from the Functions pull-down on the action bar. ISPF displays the Profile Member Name panel.

Type in a member name for the profile data set member. When you press Enter, the data set is created with the attributes RECFM=variable blocked, LRECL=203, Type=PDS.

Using a VSAM profile data set: When you have displayed a VSAM input panel, select the Get from Profile choice from the Functions pull-down on the input panel action bar to display the panel shown in Figure 92.

Menu Functions Utilities Help							
GET	USERID.VSAM.PROFILE				Row 00001 of 00001		
Name	Prompt	Size	Created	Changed	ID		
. PMNTEST		78	2002/08/05	2002/08/05 11:56:23	USERID		
End							
Command ==>							
				Scroll ==> PAGE			
F1=Help	F2=Split	F3=Exit	F5=Rfind	F7=Up	F8=Down	F9=Swap	
F10=Left	F11=Right	F12=Cancel					

Figure 92. Using a VSAM profile data set (ISRVMLGT)

When you select a profile and press Enter, the fields on the entry panel will fill with the values stored in the profile data set member.

Changing the VSAM profile data set: To change the name of the active VSAM profile data set, select the Change Profile Data Set choice from the Functions pull-down on an input panel action bar to display the panel shown in Figure 93 on page 133.

```

Menu  Function  Utilities  Help
-----
  Menu  Utilities  Help
  -----
                          Profile Data Set
  Profile Data Set . . 'USERID.VSAM.PROFILE'
  -----
Command ==>
F1=Help      F2=Split      F3=Exit      F9=Swap      F10=Actions
F12=Cancel
-----
                          3. Records
                          4. Kilobytes
:

```

Figure 93. Panel for changing the name of the VSAM profile data set (ISRUVGET)

You can type the name of a different profile data set. When you press Enter, the data set is created if it does not exist, and this data set becomes the active profile data set.

Move/Copy utility (option 3.3)

When you select this option, a panel is displayed (Figure 94) that allows you to specify the "From" data set (and member if it is partitioned) and an option to be performed. The Move/Copy Utility prevents you from moving or copying a PDS member that you or another user is currently editing.

```

Menu  RefList  Utilities  Help
-----
                          Move/Copy Utility
  C  Copy data set or member(s)          CP Copy and print
  M  Move data set or member(s)         MP Move and print
-----
Specify "From" Data Set below, then press Enter key

From ISPF Library:
Project . . . _____ (--- Options C and CP only ---)
Group . . . . _____ . . . . _____ . . . . _____
Type . . . . _____
Member . . . _____ (Blank or pattern for member list,
                          "*" for all members)

From Other Partitioned or Sequential Data Set:
Data Set Name . . . _____
Volume Serial . . . _____ (If not cataloged)

Data Set Password . . (If password protected)
Option ==>
F1=Help      F2=Split      F3=Exit      F7=Backward  F8=Forward  F9=Swap
F10=Actions  F12=Cancel
-----

```

Figure 94. Move/Copy Utility panel (ISRUMC1)

Move/Copy Utility panel action bar

The Move/Copy Utility panel action bar choices function as follows:

Move/Copy utility (option 3.3)

Menu For more information, see the details about the Menu Action Bar Choice in the ISPF User Interface topic in the *z/OS ISPF User's Guide Vol I*.

RefList

For information about referral lists, see the topic about Using Personal Data Set Lists and Library Lists in the *z/OS ISPF User's Guide Vol I*.

Utilities

For more information, see the details about the Utilities Action Bar Choice in the ISPF User Interface topic in the *z/OS ISPF User's Guide Vol I*.

Help The Help pull-down provides information on how to specify the "From" and "To" data sets, how to select members to copied, and the rules relating to how different data types are moved or copied.

Move/Copy Utility panel fields

All the fields on the Move/Copy Utility panel are explained in the "ISPF Libraries and Data Sets" chapter of the *z/OS ISPF User's Guide Vol I*. On this panel, you specify the data set that you want to copy, move, lock, or promote. This is called the "From" data set.

If you request a member list or specify an asterisk (*) in the Member field on the "From" panel, ISPF does not display a Member field on the "To" panel. See the Member Selection List Commands section of the "ISPF Libraries and Data Sets" chapter of the *z/OS ISPF User's Guide Vol I* for information about primary and line commands that are available for the Move/Copy utility member list display.

You can copy or move load modules stored in partitioned data sets with undefined record formats, but you cannot print them.

The deletion of any member because of a move is recorded in your ISPF log data set, if allocated.

When you complete the panel and press Enter, ISPF displays another panel that is determined by the option you selected. This panel allows you to specify the "To" or "Target" data set or controlled library. The "From" data set must already exist. If the "Target" data set does not exist the user is prompted to see if the data set should be allocated. Choices are to allocate the "Target" data set using the characteristics of the "From" data set as a model, or to allocate the new data set by specifying the characteristics for it. If the user uses the "From" data set as a model, then that data set must be cataloged and the volume field is ignored. This function can be suppressed through the ISPF Configuration table. If it is suppressed, an allocate request for a nonexistent data set fails.

Move/Copy utility options

These topics describe the options shown on the Move/Copy Utility panel:

- "C and CP — copying data sets"
- "M and MP — moving data sets" on page 136
- "Using the move/copy utility with load modules" on page 137
- "Moving or copying alias entries" on page 139
- "Member list processing when using IEBCOPY" on page 139

C and CP — copying data sets

When you use the C and CP options, ISPF supports library concatenation. This allows you to specify up to four input libraries as the "From" data set. The libraries are searched from left to right as they are entered on the panel. The

member to be copied, which is either specified in the Member field or selected from a member list, is copied from the first library in which it is found.

If you select C or CP, the panel shown in Figure 95 is displayed. This panel allows you to specify the “To” data set—the library or data set name that you want the copied data to be stored under.

Note: The Move/Copy utility does not support:

- Supplying a volume serial when attempting to copy a multivolume data set
- Copying unmovable data sets (data set organization POU or PSU).

C — copy data set or member(s): Use option C to copy a data set. You can specify either a DASD-resident sequential or partitioned data set for both the “From” or “To” data sets. The “From” data set is not deleted.

CP — copy and print: Use this option as you would use option C, except that source listings are recorded in the ISPF list data set, as follows:

- If the “To” data set is partitioned, a listing of each new or replaced member is recorded.
- If the “To” data set is sequential, a listing of its complete contents is recorded.

```

Menu  RefList  Utilities  Help
-----
COPY      From MYPROJ.DEV.SOURCE
                                                More:      +
Specify "To" Data Set Below

To ISPF Library:          Options:
Project  . . MYPROJ      Enter "/" to select option
Group   . . . DEV        /  Replace like-named members
Type    . . . SOURCE     /  Process member aliases

To Other Partitioned or Sequential Data Set:
Data Set Name . . . _____
Volume Serial . . . _____ (If not cataloged)

Data Set Password . . . _____ (If password protected)

To Data Set Options:
Sequential Disposition      Pack Option      SCLM Setting
  1. Mod                    3  1. Yes        3  1. SCLM
  2. Old                    2. No           2. Non-SCLM

Command ==>>>
F1=Help      F2=Split    F3=Exit     F7=Backward  F8=Forward  F9=Swap
F10=Actions  F12=Cancel
  
```

Figure 95. Move/Copy Utility - “To” panel for copying (ISRUMC2B)

All the fields on the Move/Copy Utility “To” panels for copying data sets are explained in the Libraries and Data Sets topic in the *z/OS ISPF User’s Guide Vol I*, except these general Options and To Data Set Options:

Replace like-named PDS members

Select this option to allow replacement of a member in the “To” data set with a like-named member in the “From” data set.

Process member aliases

Select this option to allow the primary member and all alias members to be copied together.

Move/Copy utility (option 3.3)

Sequential Disposition

If the “To” data set is sequential, enter:

- 1 To add the “From” data set to the end of the “To” data set (Mod).
- 2 To replace the “To” data set's entire contents with the contents of the “From” data set (Old).

If the “From” data set consists of several members of an ISPF library or a partitioned data set to be moved or copied to a sequential data set, the members are written to the “To” data set one after another. The “To” data set disposition (Old or Mod) controls only the beginning location of the “To” data set after the copy or move is completed.

Pack Option

To indicate how the data is to be stored in the “To” data set, enter:

- 1 If you want the data in the “To” data set to be packed.
- 2 If you do not want the data in the “To” data set to be packed.
- 3 If you want the data to be stored in the same format in the “To” data set as it is in the “From” data set.

If you are copying data to a sequential data set with disposition of MOD, you cannot mix packed and unpacked data, nor can you copy multiple packed members.

The technique used to pack data is an internal algorithm used only by ISPF. If the data is packed, attempts to access or process the data outside ISPF can cause unwanted results. See the description of the PACK primary command in *z/OS ISPF Edit and Edit Macros* for more information.

SCLM Setting

The SCLM setting is a bit that ISPF uses to determine what type of edit the file last had performed upon it.

1 SCLM

This bit is ON to specify that the last edit of this file was under SCLM control.

2 Non-SCLM

This bit is ON to specify that the last edit of this file was under control of something other than SCLM.

3 As-is

This bit is ON to specify that this operation leaves the current setting unchanged.

M and MP — moving data sets

When you use the M and MP options, ISPF does not provide library concatenation support. You can specify up to four input libraries as the “From” data set. However, only the first library in the sequence is searched. Therefore, the member to be moved, which is either specified in the Member field or selected from a member list, is moved only if it is found in the first library. However, the other three library names remain on the panel and can be used with the C and CP options.

If you select M or MP, the panel shown in Figure 96 on page 137 is displayed. This panel allows you to specify the “To” data set—the library or data set name that you want the moved data stored under.

Note: The Move/Copy utility does not support:

- Supplying a volume serial when attempting to copy a multivolume data set
- Copying unmovable data sets (data set organization POU or PSU).

M — move data set or member(s): Use option M to move a data set. You can specify either a DASD-resident sequential or partitioned data set for both the “From” or “To” data sets.

Option M causes data sets to be deleted after they have been successfully moved to the “To” data set, as follows:

- If the “From” data set is partitioned, the selected members are deleted from it.
- If the “From” data set is sequential, the complete “From” data set is deleted.

MP — move and print: Same as option M, except source listings are recorded in the ISPF list data set, as follows:

- If the “To” data set is partitioned, a listing of each new or replaced member is recorded.
- If the “To” data set is sequential, a listing of its complete contents is recorded.

```

Menu  RefList  Utilities  Help
-----
MOVE      From MYPROJ.DEV.SOURCE
                                                More:      +
Specify "To" Data Set Below

To ISPF Library:
Project   . . MYPROJ
Group    . . . DEV
Type     . . . SOURCE

Options:
Enter "/" to select option
         /  Replace like-named members
         /  Process member aliases

To Other Partitioned or Sequential Data Set:
Data Set Name . . . _____
Volume Serial . . . _____ (If not cataloged)

Data Set Password . . . (If password protected)

To Data Set Options:
Sequential Disposition      Pack Option      SCLM Setting
 1 1. Mod                    3 1. Yes        3 1. SCLM
 2 2. Old                    2 2. No        2 2. Non-SCLM

Command ==>
F1=Help   F2=Split   F3=Exit   F7=Backward F8=Forward F9=Swap
F10=Actions F12=Cancel
    
```

Figure 96. Move/Copy Utility - "To" panel for moving (ISRUMC2B)

All the fields on the Move/Copy Utility “To” panels for moving data sets are explained in the “ISPF Libraries and Data Sets” chapter of the *z/OS ISPF User’s Guide Vol I*, except these general Options and To Data Set Options:

- Replace like-named PDS members.
- Process member aliases
- Sequential Disposition
- Pack Option
- SCLM Settings

See “C and CP — copying data sets” on page 134 for descriptions of these fields.

Using the move/copy utility with load modules

For a move or copy of load modules, these rules apply:

Move/Copy utility (option 3.3)

- Both data sets must be partitioned and must have an undefined record format (RECFM=U).
- Load modules that were created for planned overlay cannot be moved or copied.
- The print option, if specified, is ignored.
- If the "To" library is LLA-managed, it must be in NOFREEZE mode.
- For Move or Copy, reblocking can be done for load modules only, and is done by using the IEBCOPY COPYMOD function. Whether the load module is reblocked depends on the block sizes for the "To" and "From" data sets, as well as the value of the USE_IEBCOPY_COPY_OR_COPYMOD_OPTION and WHEN_TO_USE_IEBCOPY keyword settings in the ISPF Configuration table (see *z/OS ISPF Planning and Customizing* for more information).
 - If the WHEN_TO_USE_IEBCOPY setting is 0, IEBCOPY is only used:
 - When copying from a data set with a larger block size to a data set with a smaller block size.
 - When a PDSE has been specified in the "From" data set concatenation or as the "To" data set.
 - If the WHEN_TO_USE_IEBCOPY setting is 1, IEBCOPY is always used to copy load modules.
 - If the WHEN_TO_USE_IEBCOPY setting is 2, IEBCOPY is only used when a PDSE has been specified in the "From" data set concatenation or as the "To" data set.
 - If the WHEN_TO_USE_IEBCOPY setting indicates that IEBCOPY should be used, these rules apply when determining whether to reblock or not:
 - When the USE_IEBCOPY_COPY_OR_COPYMOD_OPTION setting is 1:
 - If the "To" and "From" block sizes are the same, no reblocking occurs. ISPF uses IEBCOPY COPY.
 - If the "To" block size is larger than the "From" block size, no reblocking occurs. ISPF uses IEBCOPY COPY.
 - If the "To" block size is smaller than the "From" block size, reblocking occurs. ISPF uses IEBCOPY COPYMOD.
 - When the USE_IEBCOPY_COPY_OR_COPYMOD_OPTION setting is 2:
 - If the "To" and "From" block sizes are the same, no reblocking occurs. ISPF uses IEBCOPY COPY.
 - If the "To" block size is larger than the "From" block size, reblocking occurs. ISPF uses IEBCOPY COPYMOD.
 - If the "To" block size is smaller than the "From" block size, reblocking occurs. ISPF uses IEBCOPY COPYMOD.
 - When the USE_IEBCOPY_COPY_OR_COPYMOD_OPTION setting is 3:
 - Reblocking occurs. ISPF uses IEBCOPY COPYMOD.
- If IEBCOPY is used to process the copy, ISPF allocates these data sets:
 - zprefix.zuser.SPFnnn.IEBCOPY**
IEBCOPY SYSPRINT data set
 - SYSIN**
IEBCOPY SYSIN data set
 - SYSUT3 and SYSUT4**
IEBCOPY work data sets

The SYSPRINT data set is deleted when the copy ends successfully. If errors are encountered, it is kept to help you diagnose errors. SYSIN, SYSUT3, and SYSUT4 are temporary data sets that use VIO if available, and are freed upon completion of the copy. All allocations use the value of ISPF Configuration table keyword PDF_DEFAULT_UNIT as the unit. The sizes for the SYSUT3 and SYSUT4 data

sets are calculated dynamically, based on the number of members to be copied. If this is not sufficient for your move/copy request, these DDNAMES can be preallocated. If they are preallocated, ISPF does not free them when the copy is finished.

Moving or copying alias entries

Alias entries can be moved or copied from one partitioned data set to another under these conditions:

- If the "To" library is LLA-managed, it must be in NOFREEZE mode
- If the "Process member aliases" option has been selected (ALIAS mode), these rules apply:
 - Either the Primary member or any alias member may be selected to copy the primary member and all of its aliases. This will occur even if a single member is specified or some of the members are not displayed in the current member selection list.
 - Alias members are copied for both load and non-load data sets, as well as for PDS and PDSE data sets.
 - Copying to the same data set is not supported when aliases are automatically selected, as this would result in the from and to member name being the same.
- If ISPF is not using IEBCOPY and the "Process member aliases" option has not been selected (NOALIAS mode):
 - After the move or copy is successfully completed for the main member or members, then the alias entry or entries can be copied.
 - From a member list:
 - When the main member or members are selected first, are not renamed, and are successfully moved or copied, then the alias entry or entries can be copied if they are selected without leaving the member list.
 - If the target data set is a PDSE, alias entries cannot be copied.
- If IEBCOPY is being used and NOALIAS is in effect:
 - The method described for copying when not using IEBCOPY will also work when using IEBCOPY. In addition, if all main members and aliases are selected at the same time they are processed by the same invocation of IEBCOPY and are copied correctly.
 - If the target data set is a PDSE, alias entries must be selected and processed together with the main member.

In all other cases for move and copy where NOALIAS is in effect, you can select alias names, but they are not preserved as aliases in the "To" data set. That is, the members to which they refer are moved or copied, and the alias entries are stored in the "To" data set with the alias flags turned off.

Member list processing when using IEBCOPY

When copying load modules using the IEBCOPY interface, all selected members are processed as a group. This means that the processing does not stop on the first failure but will attempt to process all selected members before the member list is redisplayed. The Prompt field will be updated to indicate the result for each individual member.

No error message is displayed if two or more members are not processed successfully because they may have failed for different reasons. Reselecting a

Move/Copy utility (option 3.3)

member and processing it individually will display a specific error message if the processing for that member fails again. These values can appear in the Prompt field:

***COPIED**

Member was copied or copied/locked successfully

***MOVED**

Member was moved successfully

***REPL** Member was replaced in the output library (Moved or Copied)

***NO DATA**

Member was not found in the input library or BLDL error

***INUSE-I**

ENQ failed on input member

***INUSE-O**

ENQ failed on output member

***NO-COPY**

Member was not copied successfully

***MIXED**

You are attempting to mix load and non-load data

***NO-DEL**

The delete step failed on a Move request

***NO-REPL**

Member exists in the output library and replace not requested

***NO-LOCK**

LMF lock failed on Copy/Lock request

***ALIAS**

Member is a PDSE Program Object alias and cannot be copied individually. It will be copied when the main member is copied.

Data set list utility (option 3.4)

When you select this option, the Data Set List Utility panel (Figure 97 on page 141) is displayed. You can either display or print lists of ISPF libraries, data sets, or volume table of contents (VTOC) information.

```

Menu  RefList  RefMode  Utilities  Help
-----
Data Set List Utility

blank Display data set list          P Print data set list
  V Display VTOC information          PV Print VTOC information

Enter one or both of the parameters below:
Dname Level . . . PDFTOOL.COMMON
Volume serial . . . _____

Data set list options
Initial View          Enter "/" to select option
 1 1. Volume          / Confirm Data Set Delete
 2 2. Space           / Confirm Member Delete
 3 3. Attrib          / Include Additional Qualifiers
 4 4. Total           / Display Catalog Name
                          / Display Total Tracks
                          - Prefix Dname Level

When the data set list is displayed, enter either:
"/" on the data set list command field for the command prompt pop-up,
an ISPF line command, the name of a TSO command, CLIST, or REXX exec, or
"=" to execute the previous command.
Option ==>
F1=Help      F2=Split    F3=Exit      F7=Backward  F8=Forward  F9=Swap
F10=Actions  F12=Cancel

```

Figure 97. Data Set List Utility panel (ISRUDLP)

Data Set List Utility panel action bar

The Data Set List Utility Panel action bar choices function as follows:

Menu For more information, see the details about the Menu Action Bar Choice in the ISPF User Interface topic in the *z/OS ISPF User's Guide Vol I*.

RefList

For information about referral lists, see the topic about Using Personal Data Set Lists and Library Lists in the *z/OS ISPF User's Guide Vol I*.

Note: When you use a referral list from within the Data Set List Utility, these functions are performed before the referral list is processed:

- The quotes are removed from the data set name.
- The value in ZPREFIX is added preceding the non-quoted data set name if the first qualifier is not ZPREFIX.
- The member name is removed.

RefMode

For information about referral list modes, see the details about Personal List Modes in the Using Personal Data Set Lists and Library Lists topic in the *z/OS ISPF User's Guide Vol I*.

Utilities

For more information, see the details about the Utilities Action Bar Choice in the ISPF User Interface topic in the *z/OS ISPF User's Guide Vol I*.

Help The Help pull-down provides information about displaying and printing data set lists and VTOC information.

Data Set List Utility panel fields

The fields on this panel are:

Dsname level

This field is used to specify the level or levels of any data set that you want ISPF to list or print for you. An optional installation exit, called the data set list (DSLISL) exit, can control whether a data set name should appear in the list. See *z/OS ISPF Planning and Customizing* for more information about this exit.

When you specify the Dsname Level, you are defining the level qualifiers for the data set names to be included in the list. Therefore, in Figure 97 on page 141, the value PDFTOOL.COMMON represents the first two levels of a data set name. An ISPF library typically has a three-level name: project, group, and type.

The Dsname Level field supports the inclusion of system symbols.

ISPF retains the information you put in this field and displays it the next time you use this panel.

Except for the first level, you can specify the level qualifiers fully, partially, or use defaults. Do not enclose the value in the Dsname Level field in quotes.

Asterisks and percent signs may be used to filter the list of data sets that is displayed. For ICF catalog lists and volume lists, asterisks and percent signs may be used in the high-level qualifier. Asterisks may be used anywhere in a qualifier, not just in the first and last positions. However, one qualifier must be at least partially qualified.

A single asterisk by itself indicates that at least one qualifier is needed to occupy that position. A single asterisk within a qualifier indicates that zero or more characters can occupy that position. A double asterisk by itself indicates that zero or more qualifiers can occupy that position. A double asterisk is invalid within a qualifier.

In this example, all data set names with SYS1 as the first qualifier and at least one other qualifier will be listed.

```
SYS1.*
```

In this example, all data set names with SYS1 as the first qualifier will be listed.

```
SYS1 or SYS1.**
```

In this example, all data set names that have a qualifier of CLIST and are in catalogs that you have authority to will be listed. A VTOC list will contain all data set names that have a qualifier of CLIST.

```
** .CLIST
```

Note:

1. If you enter a high-level qualifier of '*' or '**', ISPF displays a pop-up window to warn you that the search will be for all catalogs on the system and will take time. If there are many catalogs, this search could take a considerable amount of time. You can press Enter to continue the search, or you can enter Cancel or End from the pop-up window to cancel the search. Be aware that if you have mount authority, a catalog search with '*' or '**' as the high-level qualifier can require that volumes be mounted for the catalogs to be searched.

2. The ISPF Configuration table contains a selectable option, named DISALLOW_WILDCARDS_IN_HLQ, to disallow the use of the '*' or '%' in the high-level qualifier.
3. If the first character of the dsname level is a dot(.), tilde (~) or forward slash (/), the string is passed unchanged to UDLIST. No exits or other processing normally associated with the Data Set List Utility is performed.

A single percent sign indicates that any one single alphanumeric or national character can occupy that position. One to eight percent signs can be specified in each qualifier. This example is valid for Dsname Level:

AAA%*.B*%%B.C

In this example, the list will contain all data sets that start with AAA and one or more other characters, have a second qualifier that starts and ends with B and has at least three other characters between the B's, and have a third qualifier of 'C'. The list will contain entries from catalogs that you have authority to. A VTOC list will contain entries that match these characteristics.

In this example, the list will contain all data sets that start with SYS and one other character, such as SYS1 or SYS2.

SYS%

If you enter a SYS% alias for a SYS1 data set as the Dsname Level (for example, SYSP as a single qualifier), you see SYSP as an ALIAS because this single qualifier is an alias for SYS1. The data set names pointed to by a SYS% alias can be displayed in a data set list by entering any of these:

- a Dsname Level of SYS1 and a volume
- a Dsname Level of SYS%
- a Dsname Level of the fully qualified data set name (such as SYSP.PARMLIB)

PRO**CT is not valid as a data set name level because a double asterisk (**) is not valid in the middle of a qualifier.

Alias names that match the specified Dsname Level will be displayed as the alias name itself. The volume field for all alias names will contain the characters '*ALIAS' to indicate this. Real names that match the Dsname Level will also be displayed.

If you enter ISPFTEST as a Dsname Level and you have real data set names that start with ISPFTEST and aliases for those real names that start with ISPFTEST, you would see a list of this format:

ISPFTEST.BASE.CLIST	TSOPK1
ISPFTEST.BASE.CLIST.ALIAS	*ALIAS
ISPFTEST.BASE.SOURCE	TSOPK1
ISPFTEST.BASE.SOURCE.ALIAS	*ALIAS

A VSAM cluster entry is flagged in the volume field as '*VSAM*'. A VSAM path entry is flagged in the volume field as '*PATH*'. A VSAM alternate index entry is flagged in the volume field as '*AIX*'.

Note:

1. A catalog search may result in the DSLIST containing duplicate names. This can occur when the definition of user catalog aliases results in multiple catalogs being searched when the data set list is built. Line commands against duplicate data sets in the DSLIST are supported. Selecting the "Display Catalog Name"

Data set list utility (option 3.4)

option will display the name of the catalog associated with each data set on the Total view. This can identify where duplicate data set names were found. The existence of duplicates may be inconsistent when changing the DSLEVEL qualifiers. For example, SYS1.PARM.* may have different results than SYS1.PAR*. Duplicate entries may or may not display in a consistent manner, however the DSLIST will always be complete, with no omissions.

2. If a VSAM cluster matches the Dsname Level, all parts of the cluster are listed even if the data and index portions do not match the Dsname Level.

When a multicluster (key-range) data portion of a VSAM cluster is displayed on a catalog list, no information is shown except for the volume and device. The information comes from the VTOC and the catalog name does not match the VTOC name. When using a VTOC list the information is displayed.

Volume serial

Use this field to specify the volume serial whose VTOC is to be used by ISPF to display or print a list of data set names or VTOC information. ISPF retains the information you put in this field and displays it the next time you use this panel.

If you want to display a list of only the data sets that reside on a particular volume, leave the Dsname Level field blank and enter the volume serial in the Volume field.

The Volume serial field supports the inclusion of system symbols.

You can enter a single volume name or a generic volume name to list data sets from more than one volume. The volume name can be partially specified using asterisks as global volume name characters and percent signs as placeholders in the volume name. A single asterisk within a volume name indicates that zero or more characters can occupy that position. A single percent sign indicates that any one alphanumeric or national character can occupy that position. Examples follow.

* Lists data set names matching the Dsname Level from all volumes

PRM* Lists names from all volumes beginning with 'PRM'

M%C*

Lists names from volumes beginning with 'M', followed by any single character, a 'C', and any three other characters

Note:

1. During pre-allocation verification processing for a data set list line command, ISPF issues a LOCATE (SVC 26) for the data set name. This occurs even when you specify a volume serial on the Data Set List Utility panel. If this LOCATE fails (for example, an SMS data set by the same name exists and the volume for the SMS data set is not available), ISPF issues an error message and the line command fails.
2. Specifying a single asterisk as a volume name will require more time to display or print the VTOC list.
3. A generic volume name can not be used to display VTOC information.

Initial view

Use this field to tell ISPF which view of the data set list you would like to see. ISPF retains the information you put in this field and displays it the next time you use this panel.

All the scroll commands function normally from these displays, except for the LEFT and RIGHT commands. These commands switch from one view to another, because the panels used to show the different views are connected as if they formed a ring. Each time you enter the LEFT or RIGHT command, another view is displayed in the sequence shown in Figure 98, starting from the current view.

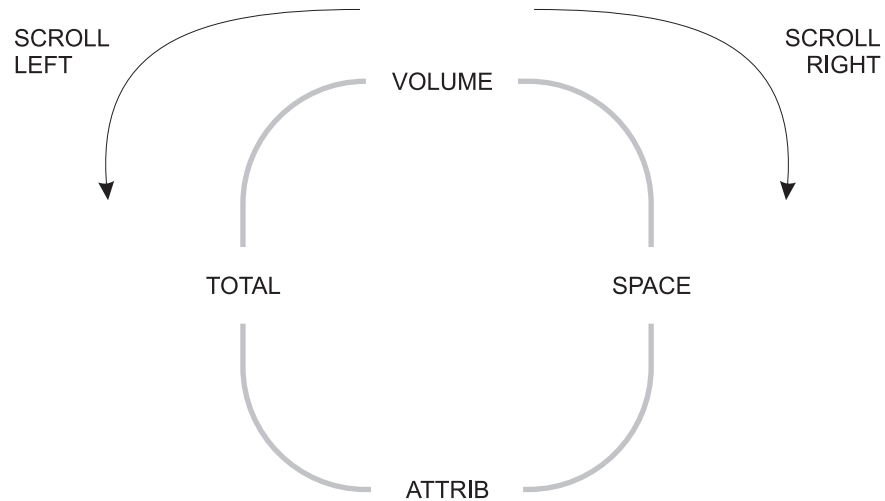

Figure 98. Sequence of data set list display views

If you enter the RIGHT command with the Total view in the sequence displayed, ISPF displays the Volume view. If you enter the LEFT command with the Volume view displayed, ISPF displays the Total view. The available views are:

1. Volume

This view shows a data set list that contains data set names and the volumes on which they reside. Figure 99 on page 149 shows a typical data set list display using the Volume view.

2. Space

The Space view shows a data set list that contains data set names, tracks, percentages used, extents, and devices. An additional header line, displayed above the column headings and showing the total tracks of all data sets, the total tracks of all non-excluded data sets, the number of data sets listed and the number of non-excluded data sets listed, is displayed if the Display Total Tracks option is selected. Figure 100 on page 151 shows a typical data set list display using the Space view with the Total Tracks header line.

3. Attrib

This view shows a data set list that contains data set names, data set organizations, record formats, logical record lengths, and block sizes. Figure 101 on page 151 shows a typical data set list display using the Attributes view.

Note: For each of the views, the list is sorted by data set name. See the list under Figure 102 on page 152 for descriptions of the fields shown on this panel.

4. Total

This view shows a data set list that contains all the information displayed

Data set list utility (option 3.4)

by the Volume, Space, and Attributes views, plus the created and expired or referred dates. (The **Display Expiration Date option on the DSLIST Settings of the options pull-down on the Data Set List utility (option 3.4) allows you to display either the expiration date or the referred date of the data set.**) The list is sorted by data set name and has two lines per data set. Figure 102 on page 152 shows a typical data set list display using the Total view.

The catalog name can also be displayed if the Display Catalog Name option is selected and no value is entered into the Volume Serial field. If the Display Catalog Name option is selected, three lines per data set are displayed. Figure 103 on page 152 shows a typical data set list display using the Total view with the Catalog name. See the list under the figure for descriptions of the fields shown on this panel.

An additional header line, displayed above the column headings and showing the total tracks of all data sets, the total tracks of all non-excluded datasets, the number of data sets listed, and the number of non-excluded data sets listed, is displayed if the Display Total Tracks option is selected.

Confirm data set delete

This field controls whether the Confirm Delete panel appears when you use the D (delete data set) line command or the TSO DELETE command from the displayed data set list. Use a slash to select this option.

If you select this option, ISPF displays the Confirm Delete panel (Figure 86 on page 125), giving you an opportunity to change your mind and keep the data set. If you try to delete an unexpired data set, the Confirm Purge panel (Figure 87 on page 126) is displayed following the Confirm Delete panel. Follow the directions on the panel to either confirm or cancel the data set purge.

Attention:

If you deselect the option and the data set is deleted, it cannot be retrieved.

See “D — delete data set” on page 166 for more information about the D line command.

Confirm member delete

This field controls whether the Confirm Member Delete panel is displayed when you use the D (delete) command for a member in the displayed data set list. Use a slash to select this option.

If you select this option, ISPF displays the Confirm Member Delete panel. This panel gives you an opportunity to change your mind and keep the member.

Include additional qualifiers

This field is used to generate the data set list with all data sets matching the qualifiers in the Dsname Level field, including data sets with additional qualifiers.

If this field is not selected, the data set list will include only data sets that match the qualifiers entered in the Dsname Level field.

Examples: Assume that these data sets exist:

```
PDFTOOL.COMMON.ASM
PDFTOOL.COMMON.CLIST
PDFTOOL.COMMON.CLIST.OLD
```

```

PDFTOOL.COMMON.CLIST.VB
PDFTOOL.COMMON.CNTL
PDFTOOL.COMMON.CNTL.INPUT
PDFTOOL.COMMON.EXEC

```

1. List data sets whose name starts with PDFTOOL.COMMON. The data set can include additional qualifiers:

```

Dsname Level . . . PDFTOOL.COMMON / Include Additional Qualifiers
PDFTOOL.COMMON.ASM
PDFTOOL.COMMON.CLIST
PDFTOOL.COMMON.CLIST.OLD
PDFTOOL.COMMON.CLIST.VB
PDFTOOL.COMMON.CNTL
PDFTOOL.COMMON.CNTL.INPUT
PDFTOOL.COMMON.EXEC

```

2. List data sets whose name is PDFTOOL.COMMON, with no additional qualifiers:

```

Dsname Level . . . PDFTOOL.COMMON _ Include Additional Qualifiers
(No data set names found)

```

3. List data sets whose name starts with PDFTOOL.COMMON and whose third qualifier starts with "C". The data set can include additional qualifiers:

```

Dsname Level . . . PDFTOOL.COMMON.C* / Include Additional Qualifiers
PDFTOOL.COMMON.CLIST
PDFTOOL.COMMON.CLIST.OLD
PDFTOOL.COMMON.CLIST.VB
PDFTOOL.COMMON.CNTL
PDFTOOL.COMMON.CNTL.INPUT

```

4. List data sets whose name starts with PDFTOOL.COMMON and whose third qualifier starts with "C". The data set must not have additional qualifiers after the third qualifier:

```

Dsname Level . . . PDFTOOL.COMMON.C* _ Include Additional Qualifiers
PDFTOOL.COMMON.CLIST
PDFTOOL.COMMON.CNTL

```

Display catalog name

Use this option to have the Total view display for each data set in the list the name of the catalog in which the data set was located.

The option is only applicable when a catalog search is used to build the Data Set List, therefore, it is ignored when a value is entered in the Volume Serial field.

Display total tracks

Use this option to display an additional header line on the Space or the Total view, showing the total tracks of all data sets, the total tracks of all non-excluded data sets, the number of data sets listed, and the number of non-excluded data sets listed.

Depending on the size of the data set list, processing time increases because the tracks information for all data sets has to be collected before the list is displayed. When the list comprises 50 data sets or more, a pop-up panel is displayed, indicating the progress of the data collection. The keyboard locks when this pop-up panel appears and stays locked until the data set list is displayed.

Prefix Dsname Level

Use this option to have ISPF automatically add your TSO user prefix as the first qualifier of the Dsname Level. When this option is selected and you have created a TSO user prefix, that prefix is added to the beginning of the Dsname Level

Data set list utility (option 3.4)

provided the Dsname Level is not enclosed in single quotes. If the Dsname Level is entered enclosed in quotes, ISPF will not add your TSO user prefix. When this option is not selected ISPF will not accept the Dsname Level enclosed in quotes.

Data set list utility options

Sub-sections describe the options shown on the Data Set List Utility panel.

Blank — display data set list

Leave the Option line blank to display a data set list. You can use these parameters to control what data set information is displayed and how delete requests are processed:

1. Enter one or more data set name level qualifiers in the Dsname Level field. See "Dsname Level" for more information.
2. Enter a volume serial in the Volume field if you want ISPF to create a data set list from the VTOC. If you leave this field blank, the list is created from the catalog. See "Volume serial" on page 144 for more information.
3. In the Initial View field, enter the view of the data set list (Volume, Space, Attributes, or Total) that you want to see first. Examples of these views are shown in Figure 99 on page 149, Figure 100 on page 151, Figure 101 on page 151, and Figure 102 on page 152, respectively.
4. Enter a slash (/) in the Confirm Data Set Delete field to tell ISPF to display a confirmation panel if you enter the D (delete data set) line command or the TSO DELETE command. See "Confirm data set delete" on page 146 for more information.
5. Enter a slash (/) in the Confirm Member Delete field to tell ISPF to display a confirmation panel if you enter the D (delete) command for a member in a data set list.
6. Enter a slash (/) in the Include Additional Qualifiers field to tell ISPF to list all data sets that match the qualifiers in the Dsname Level field, including data sets with additional qualifiers.
7. Enter a slash (/) in the Display Catalog Name field to tell ISPF to display the name of the catalog associated with each data set in the Total view.
8. Enter a slash (/) in the Display Total Tracks field to tell ISPF to display an additional header line above the column headings, showing the total tracks of all data sets, the total tracks of all non-excluded data sets, the number of data sets listed and the number of non-excluded data sets listed. Depending on the size of the data set list, processing time increases because the tracks information has to be collected for the whole list up front. When the list comprises 50 data sets or more, a pop-up panel is displayed, indicating the progress of the data collection.
9. Enter a slash (/) to prefix the data set name level qualifiers in the Dsname Level field.
10. Press Enter to display the data set list, as shown in Figure 99 on page 149.

Note: If a plus displays after the volume serial (for example, HSM020+) on a list obtained from the catalog, the data set spans multiple volumes. Information displayed about that data set by selecting Information or Short Information or by using the Space or Total view will represent the total amounts across all used volumes. For further information, see the description for **Volume** at 155.

When a VTOC list is displayed and a multivolume data set is included on that volume, there will not be an indicator that this data set spans multiple volumes, and the information on a space or total view will be for that volume only. The

information displayed on a VTOC list is only information obtained from the VTOC of that volume. When the multivolume data set is selected for information or for short information, the space information will be for all volumes that the data set spans.

```

  Menu  Options  View  Utilities  Compilers  Help
-----
DSLIST - Data Sets Matching HANK03                               Row 1 of 14
Command - Enter "/" to select action                               Message                               Volume
-----
      HANK03                                                       *ALIAS
      HANK03.DDIR                                                  *VSAM*
      HANK03.DDIR.D                                               D$US50
      HANK03.DDIR.I                                               D$US50
      HANK03.EXEC                                                  D$US08
      HANK03.ISD1.ISPF.ISPPROF                                     D$US23
      HANK03.ISD1.ISPVCALL.TRACE                                  D$US48
      HANK03.ISPF.ISPPROF                                         D$US26
      HANK03.ISPVCALL.TRACE                                       D$US14
      HANK03.LOAD                                                  D$US08
      HANK03.MAKEDSNS.OUTPUT                                       D$US35
      HANK03.SYS2.BROADCAST                                       D$US04
      HANK03.TASID.SNAPSHOT                                       D$US05
      HANK03.TEST                                                  D$US08
***** End of Data Set list *****
Command ==>                               Scroll ==> PAGE
F1=Help  F2=Split  F3=Exit  F5=Rfind  F7=Up  F8=Down  F9=Swap
F10=Left F11=Right F12=Cancel

```

Figure 99. Data set list - volume view (ISRUDSL0)

Data set list panel action bar: The Data Set List panel action bar choices function as follows:

Menu For more information, see the details about the Menu Action Bar Choice in the ISPF User Interface topic in the *z/OS ISPF User's Guide Vol I*.

Options

The Options pull-down offers these choices:

DSLIST Settings

The settings to control the behavior of the data set list display.

Options are:

- Display Edit/View entry panel

Note: If this field is selected and a workstation Edit request is initiated when no valid workstation connection exists, ISPF indicates on the Edit/View entry panel that no connection exists and treats the request as a host Edit request.

- Update ON (Reference lists)
- List pattern for MO,CO,RS,D actions
- Show status for MO,CO,RS,D actions
- Confirm Member delete
- Confirm Data Set delete
- Do not show expanded command
- E,V,B enhanced member list

Data set list utility (option 3.4)

Selecting this choice causes the enhanced member list to be used when the E,V, or B commands are used. De-selecting this choice causes traditional member list processing to occur.

- Display Total Tracks
- Execute Block Commands for excluded Data Sets
- Display Expiration Date

Refresh List

Refresh the display of the data set list.

Append to List

Select a Personal data set list to append to the existing DSLIST. The DSLIST is rebuilt, including the data sets or data set name levels from the personal list selected.

Note: The APPEND is based on the selected personal data set list. If an entry in the list is not quoted, your TSO prefix is added as the first level of the data set name. If the entry contains a member, the member is ignored. Duplicate personal list entries are ignored. If the entry contains a volume and "Include volume on retrieve" is selected on the Referral List Settings panel, a VTOC search is used instead of the catalog. A catalog search is recommended for best performance. A volume should be used only if the data set is not cataloged.

Enter the DSLIST primary command REFRESH on the DSLIST display panel to erase all appended personal lists.

Save List

Saves the data set list to a file.

Reset Resets the data set list.

View The View pull-down offers these choices:

Note: The current setting is shown as an unavailable choice; that is, it is displayed in blue (the default) with an asterisk as the first digit of the selection number (if you are running in GUI mode, the choice will be *grayed*).

- 1** **Volume** Changes the display to the Volume view, as shown in Figure 99 on page 149.
- 2** **Space** Changes the display to the Space view.

Menu Options View Utilities Compilers Help					
DSLIS T - Data Sets Matching HANK03					Row 1 of 14
Total Tracks:	86 non-x:	86	Data Sets:	14 non-x:	14

Command - Enter "/" to select action					Tracks %Used XT

HANK03					
HANK03.DDIR					
HANK03.DDIR.D		45	?		1
HANK03.DDIR.I		1	?		1
HANK03.EXEC		15	12		1
HANK03.ISD1.ISPF.ISPPROF		1	100		1
HANK03.ISD1.ISPVCALL.TRACE		2	100		1
HANK03.ISPF.ISPPROF		1	100		1
HANK03.ISPVCALL.TRACE		2	100		1
HANK03.LOAD		15	13		1
HANK03.MAKEDSNS.OUTPUT		1	100		1
HANK03.SYS2.BROADCAST		1	0		1
HANK03.TASID.SNAPSHOT		1	100		1
Command ==>					Scroll ==> PAGE
F1=Help	F2=Split	F3=Exit	F5=Rfind	F7=Up	F8=Down
F10=Left	F11=Right	F12=Cancel			F9=Swap

Figure 100. Data set list - space view (ISRUDSL0)

3 **Attributes** Changes the display to the Attributes view.

Menu Options View Utilities Compilers Help					
DSLIS T - Data Sets Matching HANK03					Row 1 of 14
Command - Enter "/" to select action					

HANK03					
HANK03.DDIR	VS				
HANK03.DDIR.D	VS	?	?	?	
HANK03.DDIR.I	VS	?	?	?	
HANK03.EXEC	PO-E	FB	80	32720	
HANK03.ISD1.ISPF.ISPPROF	PO	FB	80	27920	
HANK03.ISD1.ISPVCALL.TRACE	PS	FB	80	27920	
HANK03.ISPF.ISPPROF	PO	FB	80	6160	
HANK03.ISPVCALL.TRACE	PS	FB	80	27920	
HANK03.LOAD	PO	U	0	32760	
HANK03.MAKEDSNS.OUTPUT	PS	FB	80	27920	
HANK03.SYS2.BROADCAST	PS	FB	150	1500	
HANK03.TASID.SNAPSHOT	PS	VBA	255	27998	
HANK03.TEST	PS	VBA	138	13800	
***** End of Data Set list *****					
Command ==>					Scroll ==> PAGE
F1=Help	F2=Split	F3=Exit	F5=Rfind	F7=Up	F8=Down
F10=Left	F11=Right	F12=Cancel			F9=Swap

Figure 101. Data set list - attributes view (ISRUDSL0)

4 **Total** Changes the display to the Total view.

Data set list utility (option 3.4)

<u>M</u> enu	<u>O</u> ptions	<u>V</u> iew	<u>U</u> tilities	<u>C</u> ompilers	<u>H</u> elp
DSLIS T - Data Sets Matching HANK03					Row 1 of 14
Total Tracks:		86 non-x:	86	Data Sets:	14 non-x: 14

Command - Enter "/" to select action					Message
Tracks	%	XT Device	Dsorg	Recfm	Lrecl Blksz Created
					Volume Referred

HANK03					*ALIAS

HANK03.DDIR					*VSAM*
VS					

HANK03.DDIR.D					D\$US50
45	?	1 3390	VS	?	? ? 2007/02/21 2007/02/21

HANK03.DDIR.I					D\$US50
1	?	1 3390	VS	?	? ? 2007/02/21 ***None***

Command ==>					Scroll ==> PAGE
F1=Help	F2=Split	F3=Exit	F5=Rfind	F7=Up	F8=Down F9=Swap
F10=Left	F11=Right	F12=Cancel			

Figure 102. Data set list - total view (ISRUDSL0)

<u>M</u> enu	<u>O</u> ptions	<u>V</u> iew	<u>U</u> tilities	<u>C</u> ompilers	<u>H</u> elp
DSLIS T - Data Sets Matching HANK03					Row 1 of 14
Total Tracks:		86 non-x:	86	Data Sets:	14 non-x: 14

Command - Enter "/" to select action					Message
Tracks	%	XT Device	Dsorg	Recfm	Lrecl Blksz Created
					Volume Referred

HANK03					*ALIAS

CATALOG.MASTER.SYSPLEXD					

HANK03.DDIR					*VSAM*
VS					

CATALOG.USER1.SYSPLEXD					

HANK03.DDIR.D					D\$US50
45	?	1 3390	VS	?	? ? 2007/02/21 2007/02/21
CATALOG.USER1.SYSPLEXD					

Command ==>					Scroll ==> PAGE
F1=Help	F2=Split	F3=Exit	F5=Rfind	F7=Up	F8=Down F9=Swap
F10=Left	F11=Right	F12=Cancel			

Figure 103. Data set list - total view with catalog name (ISRUDSL0)

- 5 **Sort** You can sort the data set list by any of these fields:
1. Name
 2. Message
 3. Volume
 4. Tracks
 5. Percent Used
 6. Extents

7. Dsorg
8. Recfm
9. Lrecl
10. Blksz
11. Creation date
12. Expiration date
13. Referenced date
14. Device
15. Volume indicator
16. Catalog

You can also specify the sort sequence (ascending or descending) or accept the default sequence for the associated sort field. By default, character fields are sorted alphabetically and numeric fields are sorted in descending order.

Utilities

For more information, see the details about the Utilities Action Bar Choice in the ISPF User Interface topic in the *z/OS ISPF User's Guide Vol I*.

Compilers

The Compilers pull-down offers you these choices:

- 1 **Foreground Compilers.** Displays the Foreground Selection Panel.
- 2 **Background Compilers.** Displays the Batch Selection Panel.
- 3 **ISPPREP Panel Utility** Displays the Preprocessed Panel Utility panel.
- 4 **DTL Compiler** Displays the ISPF Dialog Tag Language Conversion Utility panel.

Help The Help pull-down provides general information about the data set list, including the format of the displayed list and the available line commands and primary commands.

Data set list panel fields: The fields listed here can appear on the data set list panels. The fields displayed will vary depending on the view that you select.

Total Tracks

Total number of tracks of all data sets in the list.

non-x Total number of tracks of all data sets in the list, not including the tracks of all excluded data sets.

When the number of total tracks or total non-excluded tracks exceeds 10 digits (the maximum provided in the header line), the display changes as follows:

nnnnnnnnkB

Kilobyte. The total number is divided by 1000.

nnnnnnnnMB

Megabyte. The total number is divided by 1,000,000.

nnnnnnnnGB

Gigabyte. The total number is divided by 1,000,000,000.

nnnnnnnnTB

Terabyte. The total number is divided by 1,000,000,000,000.

The unchanged number of tracks and non-excluded tracks is available in the shared pool variables ZDLSIZET and ZDLSIZTX .

Data set list utility (option 3.4)

Data Sets

Total number of data sets in the list.

non-x Total number of data sets in the list, not including excluded data sets.

Command

Field used to enter a line command, TSO command, CLIST, or REXX EXEC when displaying a data set list. See "Data set list utility line commands" on page 162 for more information.

Name Data set name, as in the VTOC or catalog.

Message

This field is initially blank. After you perform an operation on a data set using one of the built-in line commands, one of these messages is displayed in this field:

LineCommand

	Message
B	Browsed
C	Cataloged
E	Edited
U	Uncataloged
D	Deleted
P	Printed
PX	Index Printed
R	Renamed
I	Info - I
M	Member List
S	Info - S
Z	Compressed
F	Free Completed
=	(message shown for last command entered)
V	Viewed
RA	Refadd
CO	Copied
MO	Moved
RS	Reset
X	- 1 data set(s) not displayed
NX	(no message)
NXF	(no message)
NXL	(no message)

If you enter a TSO command, CLIST, or REXX exec on the Command line, a default message appears in the Message field. The message you see can be one of these:

- In this format, depending on the results of the TSO command, CLIST, or REXX exec:

```
XXXXXXXX RC=#
```

where:

```
XXXXXXXX
```

The command entered

The return code.

- "ERROR MSG LOGGED".

This may occur with PDSE or HFS data sets. A fully formatted message appears in the ISPF log, provided one has been allocated.

Note: See "Data set list utility line commands" on page 162 for a description of the Data Set List Utility line commands.

Volume

Volume serial number.

An indicator may be displayed beside the Volume field:

+ (plus sign)

May be displayed beside the Volume serial field if the data set is a multiple volume data set. This is determined from the number of volume entries in the catalog. Depending on the system set-up, a "+" may not be displayed until the additional volumes have been accessed. For example, a data set with a non-zero dynamic volume count in the SMS dataclass will not show multiple volume entries in the catalog until the additional volumes have been accessed. Other vendor products which can dynamically expand the volume list will also not show multiple volume entries in the catalog until the additional volumes have been accessed.

- 1 Migrated to disk
- 2 Migrated to tape

Tracks Number of tracks allocated to the data set.

%Used

Percentage of allocated tracks used, expressed in whole numbers, not rounded. If any track is used, the minimum percentage is 1. If the data set is a PDSE, the % refers to the percentage of allocated pages used.

See "F — free unused space" on page 168 for information about freeing track space manually.

Note: Space utilization values are not displayed for VSAM or BDAM data sets.

XT Number of extents allocated to the data set.

Device

Device type on which the volume that contains the data set is mounted.

Dsorg One of the data set organizations shown. In the definitions of these data set organizations, *unmovable* means the data set contains absolute addresses instead of relative addresses. These data sets are not moved to any other DASD storage location during read/write operations.

- PS Sequential
- PS-E Sequential Extended Format
- PS-L Large Format Sequential
- PSU Sequential unmovable
- PO Partitioned
- POU Partitioned unmovable
- PO-E Partitioned extended (PDSE)
- DA Direct
- DAU Direct unmovable
- HSF MVS Hierarchical File System
- IS Indexed sequential
- ISU Indexed sequential unmovable
- VS VSAM
- VS-E VSAM Extended Format
- blank None of the preceding data set organizations.

Data set list utility (option 3.4)

Recfm Record format specified when the data set was allocated. See “A — allocate new data set” on page 114 for more information about record formats.

Lrecl Logical record length, in bytes, specified when the data set was allocated.

Blksz Block size, in bytes, specified when the data set was allocated.

Created

Creation date in the national format.

Expires

Expiration date in the national format, specified when the data set was allocated. If no expiration date was specified, *****None***** is displayed. If a “never expire” date (1999/12/31 or its equivalent) is specified, *****Perm***** is displayed. See “A — allocate new data set” on page 114 for more information about expiration dates.

Note: The expiration date is only available with the I and S line commands.

Referred

Date, in the national format, that this data set was last accessed.

Catalog

The name of the catalog in which the data set was located. Only displayed in the Total view when the Display Catalog Name option is selected and no value is entered in the Volume Serial field.

Actions you can take from the data set list panel: These topics describe actions you can take from the Data Set List panel:

- “Line commands”
- “TSO commands, CLISTs, and REXX EXECs”
- “Using the slash (/) character” on page 157
- “TSO command/CLIST/REXX exec variables” on page 158

Line commands: Line commands can be entered in the Command field to the left of the data set names. See “Data set list utility line commands” on page 162 for definitions of these line commands.

TSO commands, CLISTs, and REXX EXECs: Besides the ISPF-supplied line commands, you can also enter TSO commands, CLISTs, and REXX EXECs that use a fully qualified data set name as an operand. You can type over the field containing the data set name to enter commands that require more space than is provided in the Command field. ISPF determines the end of the command by scanning the Command field and the field containing the data set name from right to left. The first character found that differs from the original is considered to be the last character of the command. Therefore, it is best to enter a blank after the last character of your command if it extends into the field containing the data set name.

TSO commands, CLISTs, and REXX EXECs entered are invoked using the ISPF SELECT CMD service. Variable names starting with an ampersand (&) are evaluated by ISPF. If you want the underlying command processor to see the ampersand you must specify 2 ampersands. For example:

```
DEF NONVSAM(NAME(/) DEVT(0000) VOLUME(&&SYSR2))
```

Note: If the TSO command, CLIST, or REXX exec issues a return code greater than or equal to 8, processing stops and an error message is displayed.

Using the slash (/) character: If a command, CLIST, or REXX exec requires the data set name in a position other than the first operand or if other operands are needed, you can use the slash (/) character to represent the quoted data set name. If no operands are specified after the command, ISPF uses the name of the data set being acted on as the command's first operand.

To specify a member of a partitioned data set, enclose the member name or pattern in parentheses immediately following the / character. You can use this format with the V (view data set), B (browse data set), D (delete data set), E (edit data set), and M (display member list) line commands. For information about these line commands, see "Data set list utility line commands" on page 162.

You may find it helpful to call the SHOWCMD primary command before using the slash (/) for the first time. After you call SHOWCMD, a special Data Set List Utility panel appears each time you enter a line command, TSO command, CLIST, or REXX exec on a data set list display. The panel shows you the command you entered and how ISPF expanded, and thus interpreted, that command. See "SHOWCMD command" on page 176 for more information about and an example of the SHOWCMD primary command.

The rules shown apply to substituting the slash (/) character for a data set name. Each rule is followed by one or more examples that prove the rule by using either a CLIST or a line command.

In each example, the data set being acted on is USER.TEST.DATA, which always appears, either completely or partially, in uppercase. However, the CLIST or line command is typed in lowercase to differentiate between the CLIST or line command and USER.TEST.DATA when this data set name is either completely or partially typed over.

Each example also shows:

Original

The line as it appears before the CLIST or line command is entered.

As typed

The line as it appears after the CLIST or line command is typed.

After The line as it appears after the CLIST or line command is expanded to show the placement of quotes and data set name substitution for the slash (/) character.

1. You can type over the data set name. Expanded commands can contain a maximum of 255 characters and are converted to uppercase. This example shows how rule 1 would apply if you typed %clist1 da(/):

```
(Original)      USER.TEST.DATA
(As typed) %clist1 da(/).TEST.DATA
(After)      %CLIST1 DA('USER.TEST.DATA')
```
2. The data set name substitution character (/) is replaced with the quoted, fully qualified data set name if the character following the / is not a number, letter, or national character. This example shows how rule 2 would apply if you typed %clist2 / newdate(1986/03/15):

```
(Original)      USER.TEST.DATA
(As typed) %clist2 / newdate(1986/03/15)
(After)      %CLIST2 'USER.TEST.DATA' NEWDATE(1986/03/15)
```

Data set list utility (option 3.4)

3. If a slash (/) is followed immediately by a member name in parentheses, the ending quote for the data set is placed after the closing parenthesis that follows the member name. This example shows how rule 3 would apply if you typed `%clist3 da/(xyz)`:

```
(Original)          USER.TEST.DATA
(As typed) %clist3 da/(xyz).DATA
(After)    %CLIST3 DA('USER.TEST.DATA(XYZ)')
```

4. If the first operand is the unquoted data set name as it appears in the list, quotes are added around it or after a closing parenthesis following a member name. This example shows how rule 4 would apply if you typed `b` (the `B` (browse) line command) and added member `(abc)`:

```
(Original)          USER.TEST.DATA
(As typed) b       USER.TEST.DATA(abc)
(After)    B 'USER.TEST.DATA(ABC)'
```

5. If the line command does not have any operands or if the data set name has not been substituted as specified by either rule 3 or rule 4, the quoted, fully qualified data set name is added to the end of the line command. This example shows how rule 5 would apply if you typed `%clist4 user.test.fortran`:

```
(Original)          USER.TEST.DATA
(As typed) %clist4 user.test.fortran
(After)    %CLIST4 USER.TEST.FORTRAN 'USER.TEST.DATA'
```

This example shows how rule 5 would apply if you typed `%clist4 'user.test.fortran'`. The purpose of this example is to show that if you enclose the CLIST operand in quotes, ISPF still puts quotes around the data set name being acted on. The results are the same.

```
(Original)          USER.TEST.DATA
(As typed) %clist4 'user.test.fortran'
(After)    %CLIST4 'USER.TEST.FORTRAN' 'USER.TEST.DATA'
```

This example shows how rule 5 would apply if you typed `%clist5 member1(abc)`. The purpose of this example is to show that the results do not change if the CLIST operand contains a member name enclosed in parentheses.

```
(Original)          USER.TEST.DATA
(As typed) %clist5 member1(abc)ATA
(After)    %CLIST5 MEMBER1(ABC) 'USER.TEST.DATA'
```

TSO command/CLIST/REXX exec variables: If you use a TSO command, CLIST, or REXX exec, ISPF puts the variables described in Table 9 in the shared pool for the TSO command, CLIST, or REXX exec to use.

Table 9. TSO command/CLIST/REXX exec variables (output)

Variable Name	Description	Length in Characters
ZDLBLKSZ	Data set block size	5

Table 9. TSO command/CLIST/REXX exec variables (output) (continued)

Variable Name	Description	Length in Characters
ZDLCAT	Cataloged status; one of these: 0 Data set is cataloged on volume ZDLVOL. 2 Data set is cataloged on a volume other than ZDLVOL and is either: <ul style="list-style-type: none"> • on volume ZDLCAT but uncataloged • on volume ZDLCAT and defined in a user catalog that is connected to the master catalog, but not in the normal catalog search path The name of the user catalog is in ZDLCATNM. 4 Data set is uncataloged on volume ZDLVOL. 6 Data set is not cataloged on any volume and is uncataloged on volume ZDLVOL. 8 Data set is not available on volume ZDLVOL. This status is returned for data sets that have been either migrated or deleted.	(1)
ZDLCATNM	Name of the catalog in which the data set was located	44
ZDLCDATE	Creation date	10
ZDLCMD	Line command	9
ZDLCONF	Delete confirmation (Y N)	1
ZDLDEV	Device type	8
ZDLDSN	Data set name	44
ZDLDSNTP	Data set name type	8
ZDLDSORG	Data set organization	4
ZDLEDATE	Expiration date	10
ZDLEXT	Number of extents used	3
ZDLEXTX	Number of extents used, long format	5
ZDLLCMD	Expanded line command	255
ZDLLRECL	Data set logical record length	5
ZDLMIGR	Whether the data set is migrated (YES or NO)	3
ZDLMVOL	Multivolume indicator	1
ZDLOVF	Space overflow indicator	3
ZDLRDATE	Date last referenced	10
ZDLRECFM	Data set record format	5
ZDLSIZE	Data set size in tracks	6
ZDLSIZEX	Data set size in tracks, long format	12
ZDLSPACU	Space units: either BLOCKS, TRACKS, CYLINDERS, BYTES, KILOBYTES, or MEGABYTES	10
ZDLUSED	Percentage of used tracks	3
ZDLVOL	Volume	6
ZDLXSTAT	Exclude status	1

Data set list utility (option 3.4)

When you select the Display Total Tracks option, and the data set list is displayed either in SPACE view or in TOTAL view, ISPF also puts the variables described in Table 10 in the shared pool for the TSO command, CLIST, or REXX exec to use.

Table 10. TSO command/CLIST/REXX exec additional variables (output)

Variable Name	Description	Length in Characters
ZDLSIZET	Total tracks of all data sets in the list	19
ZDLSIZTX	Total tracks of all data sets in the list, not including the tracks of excluded data sets	19
ZDL DST	Total number of data sets in the list (available for all display views)	6
ZDLDSX	Total number of data sets in the list, not including the excluded data sets	6

Note: ISPF cannot calculate reliable space utilization values for VSAM or BDAM data sets. Therefore, question marks (?) are returned in variables that report space utilization for these data sets.

A TSO command, CLIST, or REXX exec can set these variables and place them in the shared pool to communicate with the Data Set List utility (option 3.4).

Table 11. TSO command/CLIST/REXX exec variables (input)

Variable Name	Description	Length in Characters
ZDLNDSN	New data set name to appear in list	44
ZDLMSG	Message to appear in list	16
ZDLREF	Refresh data set information; Y N	1

P — print data set list

Use option P to print a data set list. You must:

1. Enter one of these:
 - One or more data set name level qualifiers in the Dsname Level field and a volume serial in the Volume field. The list will contain all data sets for the specified levels and volume. Only the specified volume is searched. See “Dsname Level” and “Volume serial” on page 144 for more information.
 - One or more data set name level qualifiers in the Dsname Level field, but leave the Volume field blank. The list will contain all data sets for the specified levels that are cataloged.
 - A volume serial in the Volume field, but leave the Dsname Level field blank. The list will contain only the data sets on the specified volume. Only the specified volume is searched.

Note: All data set lists are formatted the same when they are printed. Therefore, values entered in the Initial View field have no effect when you use option P.

2. Press Enter to print the data set list. The data set list is stored in the ISPF list data set.

ISPF displays a progress status pop-up panel when the necessary information to perform a P (print data set list) command has to be retrieved and the data set list comprises 50 or more data sets. The keyboard locks when this pop-up panel appears and stays locked until the P command is completed. This happens regardless of the setting of Display Total Tracks option and the value entered in the Initial View field.

V — display VTOC information

Option V is used to display VTOC (volume table of contents) information. To use option V:

1. In the Volume field, specify the volume serial for which you want ISPF to display information.

Note: VTOC information is formatted the same, whether displayed or printed. Therefore, values entered in the Initial Display View field have no effect when you use option V.

2. Press Enter to display the VTOC information.

Note: The Dsname Level field is not applicable for the V or PV command. Only the Volume field is relevant.

Figure 104 shows an example of a VTOC display.

```

Menu RefList RefMode Utilities Help
----- VTOC Summary Information -----
Volume . . : MVS8WF

Unit . . . : 3390

Volume Data          VTOC Data          Free Space  Tracks  Cyls
Tracks . . : 50,085   Tracks . . :    59   Size . . . : 1,146   1
%Used . . :    97    %Used . . :    60   Largest . . :    22   0
Trks/Cyls:    15    Free DSCBS: 1,187

                                Free Extents . . :    323

Command ===>
F1=Help   F2=Split  F3=Exit   F9=Swap   F12=Cancel

    3. Attrib          / Include Additional Qualifiers
    4. Total           / Display Catalog Name
                   / Display Total Tracks

When the data set list is displayed, enter either:
"/" on the data set list command field for the command prompt pop-up,
an ISPF line command, the name of a TSO command, CLIST, or REXX exec, or
"=" to execute the previous command.

Option ===> V
F1=Help   F2=Split  F3=Exit   F7=Backward F8=Forward  F9=Swap
F10=Left  F11=Right  F12=Cancel

```

Figure 104. VTOC summary information panel (ISRUDSLV)

Track values do not include the remaining alternate tracks for the volume. The free space track values are the number of tracks for the free cylinders plus any additional free tracks.

The fields shown on the VTOC Summary Information panel are:

Unit Shows the type of DASD device the volume is on, such as 3380 or 3390.

Data set list utility (option 3.4)

Volume Data

Describes general information about the volume:

Tracks Total tracks on the volume.

%Used

Percentage of total tracks or pages not available for allocation.

Trks/Cyls

Number of tracks per cylinder for this volume.

VTOC Data

Describes general information about the VTOC on the volume:

Tracks Total tracks allocated to the VTOC.

%Used

Percentage of allocated tracks or pages used by data set control blocks (DSCBs).

Free DSCBS

Number of unused DSCBs.

Free Space

Describes the free space available for data set allocation on the volume under the headings Tracks and Cyls, showing:

Size Total number of free tracks and cylinders.

Largest

The largest number of contiguous free tracks and cylinders.

Free Extents

The number of free areas with free cylinders.

PV — print VTOC information

Option PV is used to print VTOC information. To use option PV:

1. Blank out the Dsname Level field.
2. In the Volume field, specify the volume serial for which you want ISPF to print information.

Note: VTOC information is formatted the same, whether displayed or printed. Therefore, values entered in the Initial View field have no effect when using option PV.

3. Press Enter to print the VTOC information. The VTOC information is stored in the ISPF list data set.

Note: The Dsname Level field is not applicable for the PV or V command. Only the Volume field is relevant.

Data set list utility line commands

After you display a data set list by leaving the Option field blank, you can enter a line command to the left of the data set name. You can also enter TSO commands, CLIST names, or REXX exec names. If a '>' is used before the CLIST or REXX exec name, the parameters passed to the command are not translated to upper case. The z/OS UNIX commands OGET and OPUT can be entered and the parameters are also not translated to upper case.

The slash (/) character, which can be used with TSO commands, CLISTs, and REXX EXECs, can also be used with the V (view data set), B (browse data set), D

(delete data set), E (edit data set), and M (display member list) line commands to specify a member name or a pattern. You can type over the field containing the data set name to enter commands that require more than the space provided. For more information about using this symbol, see "Using the slash (/) character" on page 157. For more information about member name patterns, see the details about Displaying Member Lists in the "ISPF Libraries and Data Sets" chapter in the *z/OS ISPF User's Guide Vol I*.

You can also enter line commands in block command format to execute the same line command for several data sets at once. You mark the block by typing a "/" at the beginning of a block of rows and another "/" at the end of the block of rows. You must type the line command either immediately after the // on the first row of the block, or immediately after the // on the last row of the block. You can enter several blocks of commands at the same time, but you cannot nest them. Single line commands are not allowed within a block command. You can execute all line commands, including TSO commands, Clists and REXX execs as block commands. If you have selected the DSLIST settings option **Execute Block Commands for excluded Data Sets**, all applicable excluded rows are unexcluded before the block commands are executed.

Line commands that are valid for aliases may be used with any alias data sets that are listed. Uncatalog, delete, and rename commands are not valid for alias data sets. A line command such as 'B' for browse or 'I' for information will display the real name of the data set.

The Data Set List Utility always supports the U (uncatalog) line command for tape data sets. The Data Set List Utility can support additional line commands for data sets stored on tape and other removable media, by calling external commands such as DFSMSrmm. This interface is configured in the ISPF configuration table and enabled by setting the configuration table keyword DSLIST_RM_ENABLED to YES.

Depending on the removable media interface, these line commands may be supported:

- I** Information
- S** Short Information
- D** Delete
- R** Rename
- C** Catalog
- M** Member List
- P** Print
- X** Print Index
- CO** Copy
- MO** Move

Which line commands are actually supported by a particular interface depends on the capabilities of the external command.

For more information about configuring the Data Set List Utility removable media interface, see *z/OS ISPF Planning and Customizing*.

If a CLIST, REXX exec, or program is issued against a data set, ISPF gathers information on the data set and makes it available through dialog variables. See Table 9 on page 158 for the list of those variables. If the data set being processed is on an unmounted file system, a temporary mount is issued, file system.

Data set list utility (option 3.4)

The Command field and the field containing the data set name fields make up a single point-and-shoot field. If you enter a slash in the Command field or if you select any part of the combined point-and-shoot field, the Data Set List Actions pop-up shown in Figure 105 is displayed so that you can select the command you want to use.

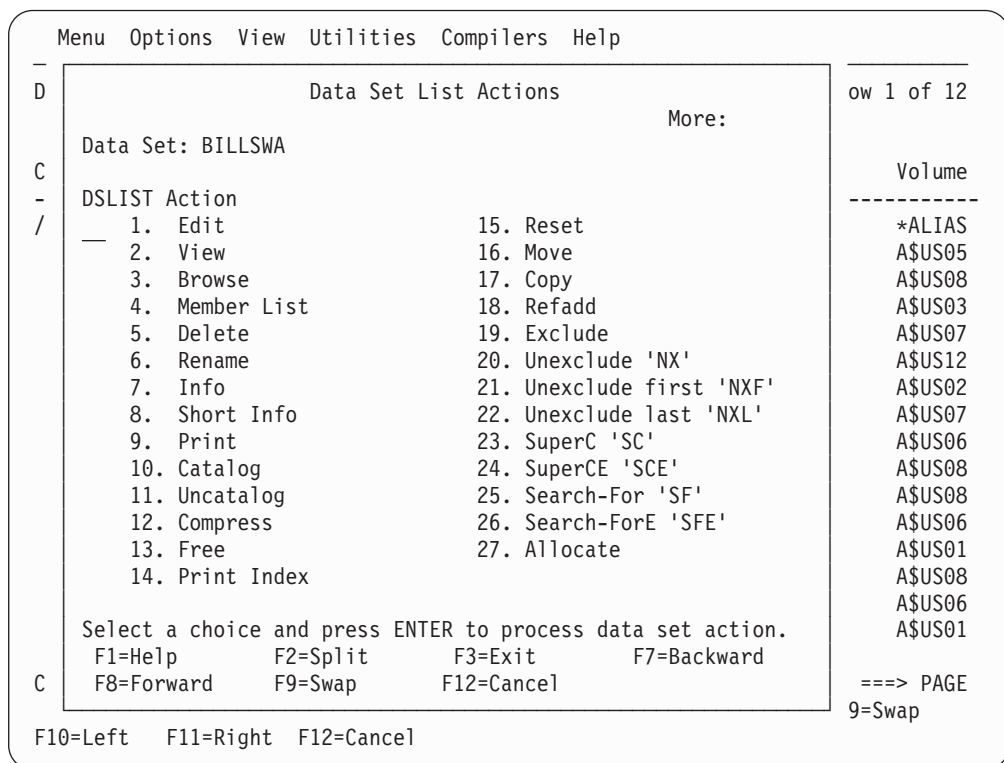

Figure 105. Data set list commands pop-up (ISRUDABC)

E — edit data set

For the E command, the processing is similar to selecting the Edit option (2) and entering the library or data set name on the Edit Entry Panel, except that mixed mode is the assumed operation mode.

Note: Multivolume data sets do not support the Volume Serial field for the Edit command.

If you select a library or other partitioned data set, an Edit member list is displayed. For more information about using member selection lists, see the “ISPF Libraries and Data Sets” chapter of the *z/OS ISPF User’s Guide Vol I*.

The E line command uses the values from a prompt panel to specify items including the initial macro, profile name, panel name, format, mixed mode, and workstation editing. These values are stored in the profile and are used on subsequent edits.

To change these values, use the “DSLISL settings” panel on the data set list Options pull-down. Check both the “E,V,B enhanced member list” and the “Display Edit/View entry panel” options. The prompt panel is always shown when you edit a sequential file, or when you directly edit a member of a partitioned data set. When you are using a member list you can force the display of the panel by placing a slash mark (/) in the Prompt field next to the member you select.

If the editor appears to be invoking an unexpected initial macro, or it appears to be using an unexpected profile, follow the process described to check the values on the prompt panel.

V — view data set

For the V command, the processing is similar to selecting the View option (1) and entering the library or data set name on the View Entry Panel. If you have set your DSLIST options to not show the edit/view entry panel:

- Mixed mode is the assumed operation mode.
- You cannot specify a data set format, an edit profile, or an initial macro.

Note: Multivolume data sets do not support the Volume Serial field for the View command.

If you select a library or other partitioned data set, an Edit member list is displayed. For more information about using member selection lists, see the “ISPF Libraries and Data Sets” chapter of the *z/OS ISPF User's Guide Vol I*.

B — browse data set

For the B command, processing is the same as if you specify Browse Mode from View (option 1), except that mixed mode is the assumed operation mode and you cannot specify a data set format. To browse a data set with mixed mode off, you must use the View option; deselect Mixed Mode and select Browse Mode on the View Entry Panel. If you enter the B line command beside an ISPF library or other partitioned data set, a Browse member list is displayed. For more information about using member selection lists, see the “ISPF Libraries and Data Sets” chapter of the *z/OS ISPF User's Guide Vol I*.

Note: From a catalog list, multivolume data sets do not support the Volume Serial field for the Browse command.

M — display member list

For the M command, a member selection list of a partitioned data set is displayed. This member list provides an expanded line command field in the area to the left of the list. The line command field in other member lists has room for only one character, unless the browse, view, or edit *enhanced* member list is selected.

From the member list, you can use the same primary commands and line commands that are valid for Library utility (option 3.1) member selection lists. See the information about Using Member Selection Lists and Library and Data Set List Utility Line Commands in the Libraries and Data Sets topic in the *z/OS ISPF User's Guide Vol I*.

Note:

1. From a VTOC list, you can browse a single volume of a multivolume non-SMS data set.
2. You can *chain* the line commands; that is, you can select multiple members from a member list for various processing tasks. Use the CANCEL command (from a View, Browse, or Edit session) to break the chain and return to the member list.

You can also enter TSO commands, CLISTs, or REXX EXECs in the Line Command field. If you enter a line command other than B (browse), D (delete), E (edit), R (rename), C (copy), M (move), G (reset), J (submit), or P (print), ISPF interprets it as a TSO command, CLIST, or REXX exec.

Data set list utility (option 3.4)

If the prompt field contains non-blank data that does not start with "*" then the prompt field data is passed as an argument:
 COMMAND 'DSN(MEMBER)' prompt

See "TSO commands, CLISTs, and REXX EXECs" on page 156 for more information.

Note: If the TSO command, CLIST, or REXX exec issues a return code greater than or equal to 8, processing stops and an error message is displayed.

Figure 106 shows an example of a member list with statistics and an expanded line command field.

Menu	Functions	Confirm	Utilities	Help	
DSLIS		MYPROJ.DEV.SOURCE		Row 0000001 of 0000373	
Command ==>				Scroll ==> PAGE	
Name	Prompt	Size	Created	Changed	ID
FL@SPCGB		21	2003/12/10	2003/12/10 02:58:01	LSACKV
FL@SPCIM		21	2003/12/15	2003/12/15 09:37:51	LSACKV
FL@SPCLO		21	2003/12/05	2003/12/05 22:52:24	LSACKV
FL@SPCMI		21	2003/12/10	2003/12/10 06:22:13	LSACKV
FL@SPCNG		21	2003/12/01	2003/12/02 23:09:25	LSACKV
FL@SPCPR		21	2003/12/12	2003/12/12 01:46:48	LSACKV
FL@SPCRA		21	2003/12/12	2003/12/12 04:03:30	LSACKV
FL@SPCSC		23	2004/04/21	2005/12/23 11:54:27	BBAGG
:					
F1=Help	F2=Split	F3=Exit	F5=Rfind	F7=Up	F8=Down
F10=Left	F11=Right	F12=Cancel			F9=Swap

Figure 106. Member list display - expanded line command field (ISRUDSM)

Figure 107 shows load module library statistics with an expanded line command field.

Menu	Functions	Confirm	Utilities	Help			
DSLIS		PDFDEV.SVT.LOAD		Row 0000001 of 0000505			
Command ==>				Scroll ==> PAGE			
Name	Prompt	Alias-of	Size	TTR	AC	AM	RM
FLM\$CP		FLMI024	0000A3E8	089B0F	00	24	24
FLM\$CPI			000000E8	00F80A	00	31	ANY
FLM\$DE		FLMI024	0000A3E8	089B0F	00	24	24
FLM\$DT		FLMI024	0000A3E8	089B0F	00	24	24
FLM\$99		FLMI024	0000A3E8	089B0F	00	24	24
FLMA			00008278	076E0D	00	31	ANY
FLMB			000AA8B8	084A10	00	31	ANY
FLMBCMD		FLMDDL	00140A68	087906	00	31	ANY
:							
F1=Help	F2=Split	F3=Exit	F5=Rfind	F7=Up	F8=Down	F9=Swap	
F10=Left	F11=Right	F12=Cancel					

Figure 107. Load module library display - expanded line command field (ISRUDSM)

D — delete data set

For the D command, the processing is the same as if you had selected option D from the Data Set utility (option 3.2) without specifying a volume serial. This command deletes and uncatalogs the entire data set. If a member name or pattern is supplied then a member delete will occur.

Note: Delete is not allowed for multivolume data sets from a VTOC list.

If you select the Confirm Delete option on the Data Set List Utility panel, the Confirm Delete panel (Figure 86 on page 125) is displayed to allow you to continue or cancel the operation. Note that Confirm Delete is forced on when deleting members by pattern. If you are trying to delete an unexpired data set, the Confirm Purge panel (Figure 87 on page 126) is also displayed.

When you delete a data set the volume name is compared to the volume name in the configuration table. If the names match, the command specified in the configuration table is used in place of the ISPF delete processing. This allows you to delete migrated data sets without first causing them to be recalled.

R — rename data set

For the R command, the processing is the same as if you had selected option R from the Data Set utility (option 3.2). The Rename Data Set panel is displayed to allow you to specify the new name.

Note: Rename is not allowed for multivolume data sets from a VTOC list.

See “R — rename entire data set” on page 123 for more information.

I — data set information

For the I command, the processing is the same as if you had selected option I from the Library utility (option 3.1) or left the Option field blank with the Data Set utility (option 3.2). See “I — data set information” on page 104 and “Information for managed data sets” on page 107 for more information.

Note:

1. For multivolume data sets, options I and S display current allocation and utilization values that represent totals from all volumes used.
2. Space utilization values are not displayed for VSAM or BDAM data sets.
3. Number of members does not include aliases for PDSE data sets.

S — information (short)

For the S command, the processing is the same as if you had selected option S from the Library utility (option 3.1) or the Data Set utility (option 3.2). See “S — short data set information” on page 108 and “Short information for managed data sets” on page 110 for more information.

Note:

1. For multivolume data sets, options I and S display current allocation and utilization values that represent totals from all volumes used.
2. Space utilization values are not displayed for VSAM or BDAM data sets.

P — print data set

For the P command, the processing is the same as if you had selected option L from the Library utility (option 3.1). This command formats the contents of a source data set for printing and records the output in the ISPF list data set. It also produces an index listing, which appears at the beginning of the output.

Note: The Print command is not allowed for multivolume data sets from a VTOC list.

Data set list utility (option 3.4)

C — catalog data set

For the C command, the processing is the same as if you had selected option C from the Data Set utility (option 3.2). See “C — catalog data set” on page 122 for more information.

Note: Multivolume data sets are always cataloged.

U — uncatalog data set

For the U command, the processing is the same as if you had selected option U from the Data Set utility (option 3.2). See “U — uncatalog data set” on page 124 for more information.

Note: The U command is not supported for multivolume data sets.

Z — compress data set

For the Z command, the processing is the same as if you had selected option C from the Library utility (option 3.1). This command recovers wasted space that was formerly occupied by deleted or updated members and is now available for use again. You do not need to compress a PDSE. If you use the Z command on a PDSE, the data is not reorganized.

The Z command calls either the IEBCOPY utility or the compress request exit routine. See *z/OS ISPF Planning and Customizing* for more information.

F — free unused space

For the F command, space that is not being used by the data set is released. For example, if a data set is allocated with 100 tracks but is only using 60 tracks, the F command releases the 40 tracks that are not being used.

Note: The F command for non-SMS multivolume data sets only releases space on the last volume written to. Volumes after the last write position may still have unused allocated space after the command completes.

However, if the data set has been allocated with CYLS (cylinders) specified as the space units, only the tracks beyond the last cylinder used are freed. For example, if a data set occupies 1.2 of 3 allocated cylinders, the F command frees all tracks beyond the last used cylinder, leaving 2 cylinders allocated.

PX — print index listing

For the PX command, the processing is the same as if you had selected option X from the Library utility (option 3.1). The index listing is recorded in the ISPF list data set. See “X — print index listing” on page 104 for more information.

Note: The Print command is not allowed for multivolume data sets from a VTOC list.

RS — reset

For the RESET command, a panel is displayed that prompts you to reset or delete ISPF statistics, and to enter a new user ID, version number, or modification level.

MO — move

For the MOVE command, a panel is displayed that prompts you for a library or data set name for the *to* data set.

Note: How aliases are handled by the MO and CO line commands depends on how the Process member aliases option is set. For more information see “Moving or copying alias entries” on page 139.

CO — copy

For the COPY command, a panel is displayed that prompts you for a library or data set name for the *to* data set.

Note: How aliases are handled by the MO and CO line commands depends on how the Process member aliases option is set. For more information see “Moving or copying alias entries” on page 139.

RA — RefAdd

For the REFADD command, you are provided with an interface to referral lists, where you can add a data set and a volume to a Personal Data Set List.

X — exclude data set

For the EXCLUDE command, one data set from a data set list is excluded from the list.

NX — unexclude data set

For the Unexclude command, one data set, or a set of data sets that have been excluded from a data set list are re-shown.

NXF — unexclude first data set

For the UNEXCLUDE FIRST command, the first of a set of excluded data sets is re-shown.

NXL — unexclude last data set

For the UNEXCLUDE LAST command, the last of a set of excluded data sets is re-shown.

SC — SuperC

The SC command invokes the SuperC Compare Utility with the data set predefined in the "New" Data Set field. These keyword parameters can be entered after the SC command:

NDSN(*new data set*)
NVOL(*volume for NDSN*)
ODSN(*old data set*)
OVOL(*volume for ODSN*)
M(*member mask*)
PROMPT

By default no prompting for SuperC information happens.

See “SuperC utility (option 3.12)” on page 207 for more information.

SCE — SuperCE

The SCE command invokes the SuperCE Compare Utility with the data set predefined in the New DS Name field. These keyword parameters can be entered after the SCE command:

NDSN(*new data set*)
NVOL(*volume for NDSN*)
ODSN(*old data set*)
OVOL(*volume for ODSN*)
M(*member mask*)
PROMPT

Data set list utility (option 3.4)

By default no prompting for SuperC information happens.

See “SuperCE utility (option 3.13)” on page 217 for more information.

SF — Search-For

The SF line command invokes the Search-For Utility on the selected data set.

If the selected data set is a PDS or PDSE then the SRCHFOR Member List function is invoked. You can provide a single search string with the SF line command. (Example: SF string1). If no search string is provided the Srchfor Options popup window is displayed. Use this panel to enter multiple search strings, process options, and output options. You can use the process options “Set EDIT FIND string” and “Set BROWSE FIND string” to initialize the FIND string in Edit and Browse from the first SRCHFOR string. Use the output option “Filter list” to list only the subset of members that contain one of the search strings.

An option E, V, or B can be entered immediately after the SF command. This will set the default action (Edit, View, or Browse) for when the S line command is used to select a member in the enhanced member list. (Example: SF B sets the default action in the member list to Browse.)

See “Search-For utility (option 3.14)” on page 230 for more information.

SFE — Search-ForE

The SFE line command invokes the Extended Search-For Utility on the selected data set.

If the selected data set is a PDS or PDSE then the SRCHFOR Member List function is invoked. You can provide a single search string with the SFE line command. (Example: SFE string1). If no search string is provided the Srchfor Options popup window is displayed. Use this panel to enter multiple search strings, process options, and output options. You can use the process options “Set EDIT FIND string” and “Set BROWSE FIND string” to initialize the FIND string in Edit and Browse from the first SRCHFOR string. Use the output option “Filter list” to list only the subset of members that contain one of the search strings.

An option E, V, or B can be entered immediately after the SFE command. This will set the default action (Edit, View, or Browse) for when the S line command is used to select a member in the enhanced member list. (Example: SFE B sets the default action in the member list to Browse.)

See “Search-ForE utility (option 3.15)” on page 236 for more information.

AL — Allocate

The AL line command uses a new data set name as a parameter. If no parameter is supplied, then the displayed data set must have been previously deleted by another command. When a new data set name is provided, then the displayed data set can be used as a model for allocation attributes.

= — repeat last command

For the = command, the most recently used line command is repeated. This command is most helpful when the same TSO command, CLIST, or REXX EXEC is to be called for more than one data set in a data set list. For example, suppose you have a CLIST named TESTABC and two data sets named USER.DATA1 and USER.DATA2. To run the CLIST with the two data sets consecutively from a data set list, you could:

1. Type TESTABC in the Command field beside USER.DATA1.
2. Type = in the Command field beside USER.DATA2.
3. Press Enter.

This procedure saves keystrokes because you type the CLIST name only once and you press Enter only once.

Data set list utility primary commands

Primary commands are available when you use the Data Set List utility. These commands, which you enter on the command line, are:

- APPEND
- CONFIRM
- EXCLUDE
- FIND and RFIND
- LC
- LOCATE
- MEMBER
- REFRESH
- RESET
- SAVE
- SHOWCMD
- SORT
- SRCHFOR
- VA, VS, VT, and VV

These topics describe these commands:

- “APPEND command”
- “CONFIRM command” on page 172
- “EXCLUDE command” on page 172
- “FIND and RFIND commands” on page 173
- “LC command” on page 173
- “LOCATE command” on page 174
- “MEMBER command” on page 174
- “REFRESH command” on page 174
- “RESET command” on page 174
- “SAVE command” on page 174
- “SHOWCMD command” on page 176
- “SORT command” on page 177
- “SRCHFOR command” on page 179
- “VA, VS, VT, and VV commands” on page 179

APPEND command

The APPEND primary command appends additional data sets to an existing displayed DSLIST. Use this format:

```

▶▶ APPEND _____
                |-----|
                | list_name |
                |-----|
                | DSname_level |
                |-----|
  
```

You can use the APPEND command with no parameters to get a list of your personal data sets. Then select the one you want to append to the current list.

If you give a *list_name* with the command, the list given is appended.

Data set list utility (option 3.4)

By specifying *DSname_level* as a parameter, you can use the resulting list to select which list to append to the current one. For example, entering `APPEND Userid.C*` gives you a list of all personal lists that begin with C as the second-level identifier. Then you can select the one to append.

By specifying *DSname_level* in quotes, data sets beginning with *DSname_level* are appended to the data set list.

The APPEND primary command accepts system symbols. For example:

```
APPEND 'SYS2.**.&SYSPLEX'
```

CONFIRM command

The CONFIRM primary command controls display of the Confirm Delete panel.

Use this format:

```
►►CONFIRM ON OFF
```

You can use these operands with the CONFIRM command:

ON Tells ISPF to display the Confirm Delete panel when you enter the D (delete data set) line command or TSO DELETE command. This is the default setting.

OFF Tells ISPF not to display the Confirm Delete panel.

For example, this command would tell ISPF not to display the Confirm Delete panel:

```
CONFIRM OFF
```

EXCLUDE command

The EXCLUDE primary command excludes data sets from a list based on a character string. Use this format:

```
►►EXCLUDE  ALL PREFIX NEXT CHARS  
FIRST SUFFIX LAST WORD PREV
```

You can use these operands with the EXCLUDE command:

character string

Tells ISPF which data set to exclude from the list.

ALL Tells ISPF to exclude every data set in the list.

NEXT | FIRST | LAST | PREV

Operands that define the starting point, direction, and extent of the lines to exclude.

PREFIX | CHARS | SUFFIX | WORD

Operands that set the conditions for a character string match.

For example, this command tells ISPF to exclude a data set that includes BILBO3 in the name from a list:

```
EXCLUDE BILB03
```

FIND and RFIND commands

The FIND primary command finds and displays a character string within the data set name. Use this format:

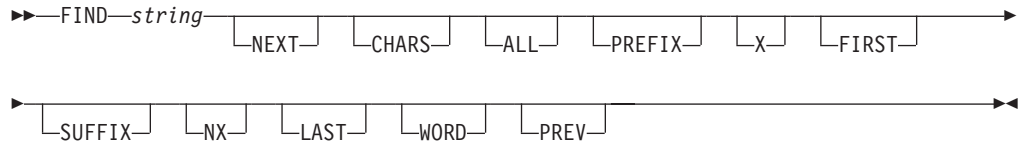

For example, this command would tell ISPF to find all occurrences of the character string ELSE:

```
FIND ELSE ALL
```

The operands X and NX can be used to limit your search to excluded (X) or unexcluded (NX) data sets.

For more information about the operands used with this command, see "FIND—find character strings" on page 85. NEXT and CHARS are the default operands.

ISPF automatically scrolls to bring the character string to the top of the list. To repeat the search without reentering the character string, use the RFIND command.

Note: RFIND search starts from the second data set in the list. It is not cursor-sensitive.

LC command

The LC primary command invokes the color change utility from the command line of a data set list display, as shown in Figure 108.

Data Set List Color Change Utility

Change one or more of the Data Set List Field Attributes and press Enter to immediately see the effect. Clearing a field restores defaults.

Field:	Color:	Intens:	Hilite:	Defaults:
Volume	BLUE	LOW	NONE	Blue
* Data Set Name . . .	GREEN	LOW	NONE	Green
Data Set Stats . . .	TURQ	LOW	NONE	Turquoise
Create,Expire,				
Catalog	YELLOW	LOW	NONE	Yellow
Message	WHITE	LOW	NONE	White
Tracks,Device . . .	WHITE	LOW	NONE	White
Marked Data Set . .	YELLOW	HIGH	NONE	Yellow

* _ Use Point-and-Shoot field attributes on Data Set Name field

----- Example -----

Command - Enter '/' to select action	Message	Volume
Tracks % XT Device Dsorg Recfm Lrecl Blksz	Created	Referred
Catalog		

ISR.V5R5M0.ISRLOAD	Browsed	HSM001
Command ==>		Defaults

F1=Help F2=Split F3=Exit F7=Backward F8=Forward F9=Swap
F12=Cancel

Figure 108. Data Set List Color Change Utility panel (ISRDLCP)

Data set list utility (option 3.4)

LOCATE command

The LOCATE primary command scrolls the list of data sets based on the field on which the data set list is sorted, as described under “SORT command” on page 177. Use this format:

```
LOCATE lparm
```

You can use the *lparm* operand with the LOCATE command for either of these situations:

- If the list is sorted by data set name, specify a data set name.
- If the list is sorted by another field, specify a value for the field by which the list is sorted.

For example, for a data set list sorted by volume, you could enter:

```
LOCATE TSOPK1
```

This command locates the first data set in the list on volume TSOPK1. If the value is not found, the list is displayed starting with the entry before which the specified value would have occurred.

MEMBER command

The MEMBER primary command is used to search for a member name or pattern in all of the partitioned data sets in the data set list. It can be abbreviated as M or MEM. The parameters, X, EX, NX, RECALL1, and RECALL2 are optional. X and EX limit the search to excluded data sets. NX limits the search to non-excluded data sets. RECALL1 includes data sets migrated to DASD in the search. RECALL2 includes all migrated data sets in the search. Use this format:

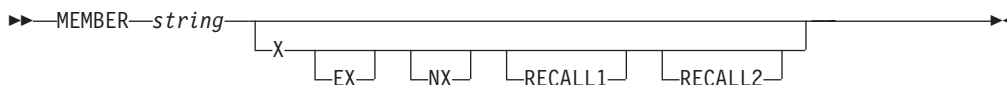

The data set list is scrolled so that the first data set containing the member or pattern is at the top of the list. The MEMBER command finds any occurrence of the specified member name or pattern within a partitioned data set.

REFRESH command

The REFRESH primary command updates the display of the data set list to whatever the list's current state is. For example, after deleting several items on the list, REFRESH causes the list to be displayed without the deleted items. If you have appended to the list, REFRESH restores the list to its status before the append operation.

RESET command

The RESET primary command unexcludes data sets that were excluded from a list, and removes any pending line commands and messages from the data set list.

SAVE command

The SAVE primary command writes the data set list to the ISPF list data set or to a sequential data set. ISPF writes the data set list in its current sort order. If the Display Catalog Name option is selected and Volume Serial was not entered, the catalog name associated with each data set is included in the Data Set List written to the sequential file. Use this format:

```

▶▶ SAVE list-id ▶▶

```

where *list-id* is an optional user-specified qualifier of the data set to which the member list will be written. ISPF names the data set:

```
prefix.userid.list-id.DATASETS
```

where:

prefix

Your data set prefix, as specified in your TSO user profile. If you have no prefix set, or if your prefix is the same as your user ID, the prefix is omitted and the data set name will be: *userid.list-id.DATASETS*.

userid

Your TSO user ID.

The data set is created if it does not exist, or written over if it exists, and has compatible attributes. If you omit the *list-id* operand, the list is written to the ISPF list data set and includes the list and column headings and this data set information:

- Data set name
- Volume
- Org
- Recfm
- Lrecl
- Blksz
- Trks
- %Used
- XT
- Created
- Catalog Name (depending on the setting of the Display Catalog Name option)

If you enter *SAVE* without a *list-id* and the Display Total Tracks option is selected, an additional header line with the accumulated tracks of all data sets and the number of all data sets in the list is written above the column headings. If you provide the *list-id* operand, the list does not include the column headings and contains all the data set information of the list without the listid provided, plus this information:

- Device
- Expires
- Referred

This command would tell ISPF to write the list to a sequential data set named either *prefix.userid.MY.DATASETS* or *userid.MY.DATASETS*.

```
SAVE MY
```

If the sequential data set already exists, ISPF writes over it; if not, ISPF creates it.

ISPF displays a progress status pop-up panel when the necessary information to perform a *SAVE* or *SORT* primary command has to be retrieved and the data set list comprises 50 or more data sets. The keyboard locks when this pop-up panel appears and stays locked until the *SAVE* or *SORT* command is completed. This happens regardless of the setting of Display Total Tracks option and the value entered in the Initial View field.

Data set list utility (option 3.4)

Note: When Display Total Tracks is ON and Initial View = 2 (Space) or 4 (Total), the pop-up panel appears during the data set list display when it comprises 50 or more data sets and all the track information is to be retrieved. When the SAVE command is subsequently issued the pop-up is not displayed as the data is already available.

SHOWCMD command

The SHOWCMD primary command controls the display of line commands and their operands as they are called. Use this format:



where:

ON Tells ISPF to display line commands. This is the default setting.

OFF

Tells ISPF not to display line commands. Though the SHOWCMD default is ON, SHOWCMD is initially set to OFF.

After you enter SHOWCMD ON, a panel (Figure 109 on page 177) is displayed each time you enter a line command, TSO command, CLIST, or REXX exec on a data set list display.

On this panel, you see the command as you typed it and then, a few lines down, you see the command as ISPF interpreted it. Seeing these commands displayed can be especially useful when you use the slash (/) character to substitute for the data set name because the panel shows the line command after expansion occurs. Therefore, you can tell immediately whether you need to add operands to the command.

For example, suppose you have a data set list displayed on the screen and decide to browse member MEMB1 of data set USER.TEST.DATA. To see how ISPF interprets the B (browse) line command, type SHOWCMD ON on the Command line and press Enter. Then, enter this line command in the Line Command field to the left of USER.TEST.DATA:

```
B /(MEMB1)
```

When you press Enter, the panel shown in Figure 109 on page 177 is displayed.

```

Data Set List Utility

Data Set Name. : MYPROJ.DEV.SOURCE

Command before expansion:
      B /(TEST)

Command after expansion:
====> B 'MYPROJ.DEV.SOURCE(TEST)'

_____
_____

The expanded command field shown here can be modified,
but the data set name field may not be changed for built-in commands.

Press ENTER key to process the command.
Enter END command to return without processing the command.

_____

Command ====> _____
F1=Help   F2=Split  F3=Exit   F9=Swap  F12=Cancel
    
```

Figure 109. Data Set List Utility - SHOWCMD panel (ISRUDSLS)

Note:

1. The data set name and commands shown in Figure 109 are for illustrative purposes only. These values are determined by the command you enter and the data set acted on by that command.
2. SHOWCMD must be entered from a data set list. It is invalid if you use a line command, such as M, to display a member list before calling it.

When the panel showing the commands is displayed, you can perform one of these actions:

- Press Enter to call the command displayed in the “Command after expansion” field.
- Change the command displayed in the “Command after expansion” field and then press Enter to call the changed command.
- Enter the END command to return to the data set list display.

For information about using line commands, TSO commands, CLISTs, REXX EXECs, and the / character on a data set list display, see “Blank — display data set list” on page 148.

SORT command

The SORT primary command sorts the data set list by the specified field. Use this format:

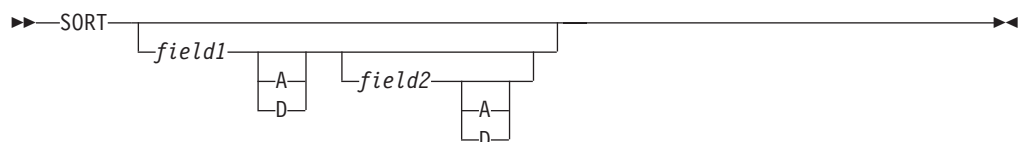

where:

Data set list utility (option 3.4)

field1

The major sort field. If only one operand is used, ISPF treats it as *field1*. If both operands are used, ISPF sorts the list by *field1* first, then by *field2* within *field1*.

field2

The minor sort field.

A|D

The direction in which values are sorted for this field (A=ascending, D=descending).

For example, to sort a data set list by volume and block size within each volume, use this command:

```
SORT VOLUME BLKSZ
```

If you do not specify a field, ISPF sorts the list by data set name. The keywords described in Table 12 tell ISPF by which fields to sort the data set list.

Table 12. Sort fields for source libraries

Field	Default Sequence	Description
NAME	Ascending	Data set name
MESSAGE	Ascending	Command completion message
VOLUME	Ascending	Volume serial
DEVICE	Ascending	Device type
DSORG	Ascending	Data set organization
RECFM	Ascending	Record format
LRECL	Descending	Logical record length
BLKSZ	Descending	Block size
TRACKS	Descending	Data set size
%USED	Descending	Percentage used
XT	Descending	Extents used
CREATED	Descending	Creation date
EXPIRES	Ascending	Expiration date
REFERRED	Descending	Last accessed data
MVOL	Ascending	Multivolume or migration level
CATALOG	Ascending	Catalog Name
PROMPT	Descending	Data displayed in PROMPT field

Automatic scrolling is performed, if necessary, to bring the major sort field into view. ISPF displays a progress status pop-up panel when the necessary information to perform a SAVE or SORT primary command has to be retrieved and the data set list comprises 50 or more data sets. The keyboard locks when this pop-up panel appears and stays locked until the SAVE or SORT command is completed. This happens regardless of the setting of Display Total Tracks option and the value entered in the Initial View field.

Note: When Display Total Tracks is ON and Initial View = 2 (Space) or 4 (Total), the pop-up panel appears during the data set list display when it comprises 50 or

more data sets and all the track information is to be retrieved. When the SORT command is subsequently issued the pop-up is not displayed as the data is already available.

SRCHFOR command

Use the SRCHFOR primary command to search the data sets in the data set list for one or more strings of data using the SuperC Utility (see Option 3.14). You may limit the search to excluded or non-excluded data sets, and control whether migrated data sets are recalled and searched or not. Use this format:

SRCHFOR string

The string parameter is optional but always converted to uppercase. If specified it is used to prefill the first search string on the subsequent DSLIST Srchfor Options panel.

WORD, SUFFIX, and PREFIX are available operands for search string specification. Note that the search strings are case sensitive and must match exactly as specified. Consider the 'Any case' process option if you want to disregard case.

Select the "ASCII" process option to cause ISPF to process the data in the data sets as ASCII. The data read from the data sets is converted from ASCII to EBCDIC. Any search string given in hexadecimal notation is assumed to be in ASCII, matching the original input data. The ASCII code page is assumed to be ISO 8859-1 (CCSID 819). The terminal code page is used as the EBCDIC code page. If the terminal code page cannot be determined code page 1047 is used.

You can use the C (continuation) operand to specify that both the current and previous string must be found on the same line to constitute a match. Otherwise, lines with either string are treated as matching.

Table 13. SRCHFOR command search string examples

Example Search strings	Explanation
===> ABC ===> EFG	Either string ABC or EFG may be found in the search data set.
===> ABC WORD ===> EFG C	The two strings (ABC and EFG) must be found on the same line. ABC must be a complete word, while EFG (a continuation definition) can be part of any word.
===> ABcD prefix	The string (ABcD) is detected if the case of each letter matches and it is a prefix of a word.
===> X'7b00'	The hex string is specified as the search string. The listing must be browsed with 'HEX ON'.
===> 'AB C'D'	The string (AB C'D) is specified.

To start the search, press the Enter key from the DSLIST Srchfor Options panel. To cancel the request and return to the Data Set List, enter END or CANCEL.

Output is in the listing DSN you specify and in the MESSAGE field in the DSLIST. Sort on this field to consolidate results.

VA, VS, VT, and VV commands

The VA, VS, VT, and VV commands change the data set list display to the Attributes, Space, Total, and Volume views, respectively.

Reset ISPF statistics utility (option 3.5)

If you have set STATS mode on, the ISPF editor automatically generates statistics for each member of a partitioned data set. You might want to reset these statistics for these reasons:

- The program you are developing has been completed and you would like to reset all version numbers before starting on the next release.
- A person has left the project, and you wish to reassign some of the members to the user ID of the person who is taking over the work.
- You would like to create ISPF statistics for some members that were created or modified on a system other than ISPF.
- You want to delete existing statistics from a partitioned data set to save space in the directory.

This option allows you to create, update, or delete statistics and to reset sequence numbers.

The Reset ISPF Statistics utility handles only partitioned data sets whose record length is in this range:

- From 1 to 32 760, inclusive, for fixed-length records
- From 5 to 32 756, inclusive, for variable-length records.

For more information about ISPF Member Statistics, see the “ISPF Libraries and Data Sets” chapter in the *z/OS ISPF User’s Guide Vol I*.

```

Menu  RefList  Utilities  Help
-----
Reset ISPF Statistics

R Reset (create/update) ISPF statistics   D Delete ISPF statistics

New Userid . . . . .      (If userid is to be changed)
New Version Number . . .  (If version number is to be changed)

SCLM Setting                                     Enter "/" to select option
3 1. SCLM   2. Non-SCLM   3. As is             / Reset Mod Level
                                           / Reset Sequence Numbers
                                           / Reset Date/Time
                                           / Reset Number of Lines
                                           Generate extended statistics

ISPF Library:
Project . . . JOHNLEV
Group . . . TEST
Type . . . DATA
Member . . . . .          (Blank or pattern for member selection
                           list, "*" for all members)

Other Partitioned Data Set:
Name . . . . .
Volume Serial . . . . .  (If not cataloged)

Data Set Password . . . . . (If password protected)
Option ==>
F1=Help   F2=Split   F3=Exit   F7=Backward  F8=Forward  F9=Swap
F10=Actions  F12=Cancel
    
```

Figure 110. Reset ISPF Statistics panel (ISRURSP)

Reset ISPF statistics panel action bar

The Reset ISPF Statistics panel action bar choices function as follows:

Menu For more information, see the details about the Menu Action Bar Choice in the ISPF User Interface topic in the *z/OS ISPF User's Guide Vol I*.

RefList

For information about referral lists, see the topic about Using Personal Data Set Lists and Library Lists in the *z/OS ISPF User's Guide Vol I*.

Utilities

For more information, see the details about the Utilities Action Bar Choice in the ISPF User Interface topic in the *z/OS ISPF User's Guide Vol I*.

Help The Help pull-down offers these choices:

- 1 General
- 2 Why you might want to Reset ISPF statistics
- 3 Filling in the reset utility panel
- 4 Using the Member list
- 6 ISPF statistics
- 7 Appendices
- 8 Index

Reset ISPF statistics panel fields

All the fields on this panel are described in the Libraries and Data Sets topic in the *z/OS ISPF User's Guide Vol I*, except these fields:

New Userid

This field is used to set the ID field in the statistics. Enter a new user ID here if you want to change the user ID the statistics are recorded under. It is required if you do not specify a new version number.

If you are updating the user ID but not resetting the sequence numbers, the statistics are updated but the data is not scanned or renumbered.

New Version Number

Enter a number here if you want to change the version number. This field is required if you do not specify a new user ID when resetting statistics. It is ignored if you are deleting statistics.

Reset Mod Level

Use a slash to select this option and reset the modification level. Deselect this option if you do not want to reset the modification level. A new version number is required to reset the modification level.

Reset Sequence Numbers

Use a slash to select this option and reset the sequence numbers. Deselect this option if you do not want to reset the sequence numbers. A new version number is required to reset the sequence numbers. Only standard (STD) sequence numbers are reset.

If the data is in packed format, there can be no sequence number processing. However, statistics for members in packed format can be created or updated if the sequence numbers are not being reset.

SCLM Settings

The SCLM setting is a bit that ISPF uses to determine what type of edit the file last had performed upon it.

1 SCLM

This bit is ON to specify that the last edit of this file was under SCLM control.

Reset ISPF statistics utility (option 3.5)

2 Non-SCLM

This bit is ON to specify that the last edit of this file was under control of something other than SCLM.

3 As-is

This bit is ON to specify that this copy operation transfers the current setting of this file as it already is.

Reset Date/Time

The setting of this option determines whether to reset the Last Modified Date or Time and the Creation Date of the file.

Reset Number of Lines

The setting of this option determines whether to reset the Current Number of Lines, the Initial Number of Lines, and the Number of Modified Lines settings. If this option is selected, the Current Number of Lines and Initial Number of Lines settings are set to the actual number of lines of the member.

The Number of Modified Lines setting is dependent on the Reset Mod Level and Reset Sequence Numbers options. If either of those are reset and the Reset Date/Time field is selected, then the value of the Number of Modified Lines is set to zero. Otherwise, the Number of Modified Lines remains as is.

Generate extended statistics

This option modifies the behavior of the **Reset Number of Lines** option.

When selected, line numbers greater than 65,535 are recorded in the PDS directory by Reset Number of Lines. More space is taken in the PDS directory by each member reset if this option is chosen.

When not selected, Reset Number of Lines records line number statistics up to a maximum of 65,535 lines and causes Extended Statistics to be cleared by Reset Number of Lines (if present).

Reset ISPF statistics utility options

These topics describe the options shown on the Reset ISPF Statistics panel:

- “R — reset (create/update) ISPF statistics”
- “D — delete ISPF statistics” on page 183
- “Results of resetting statistics” on page 183

R — reset (create/update) ISPF statistics

Use option R either to create statistics in a library that does not currently have them, or to update statistics in a library.

The New Userid field is optional for option R. If you specify a user ID, it is placed in the ID field of the statistics. If you leave the New Userid field blank and select a member without statistics, the ID field of the statistics is set to the current user ID.

Either a new user ID or a new version number is required when you use this option. When you specify a version number, the statistics are created or reset as follows:

Version Number

Set to the specified value.

Modification Level

Set to zero if requested; otherwise, unchanged.

Creation Date

Set to current date in the national format.

Change Date

Set to current date, in the national format, and time.

Current No. Lines

Set to the current number of data records.

Initial No. Lines

Set to the current number of data records.

No. Modified Lines

Set to zero if the Reset Sequence Numbers field is selected.

If you have requested updating of the modification level and resetting of the sequence numbers, the last two digits of each sequence number are set to zeros. Otherwise, they are not changed.

If you have requested updating of sequence numbers, the data is scanned to determine if valid, ascending sequence numbers are present in all records. If so, the data is renumbered. Otherwise, the data is assumed to be unnumbered and renumbering is not done.

D — delete ISPF statistics

Use option D to delete ISPF statistics for an ISPF library or other partitioned data set. The New Userid and New Version Number fields are ignored when you use option D.

Results of resetting statistics

What you specify for the New Version Number, Reset Mod Level, and Reset Sequence Numbers fields controls the resetting of the sequence numbers, the modification flags within the data, and the statistics. A new version number is required to reset the modification level and sequence numbers. Therefore, if a new version number is entered and the data is not in packed format, Table 14 shows the various combinations you can use for the Reset Mod Level and Reset Sequence Numbers fields and the results of those combinations.

Table 14. Reset mod level and reset sequence numbers combinations

	Reset Mod Level <i>Selected</i>	Reset Mod Level <i>Deselected</i>
Reset Sequence Numbers <i>Selected</i>	RESET	MOD FLAGS=UNCHANGED SEQ #s=RESET
Reset Sequence Numbers <i>Deselected</i>	Unchanged	Unchanged

Processing of alias entries

If statistics are updated or created for members of a data set by entering a wildcard as part of the member name and no member selection list is displayed, statistics for alias members are not created, thus leaving the alias bit untouched.

If alias members are selected from a member selection list, a confirmation pop-up panel is displayed for each alias selected, before creating ISPF statistics. If statistics are created for an alias member, the alias bit is turned off, effectively creating a non-alias member using the same TTR as the original member for which the alias was created.

Hardcopy utility (option 3.6)

The Hardcopy utility allows you to specify a sequential data set or a member of a partitioned data set to be printed, and the destination of the output. It also allows you to specify whether a sequential data set is to be kept or deleted after printing. Partitioned data set members are always kept.

You can use the Hardcopy utility to print any DASD-resident data set except ISPF list and log data sets; use the ISPF LIST command to print log and list data sets during an ISPF session.

An optional print utility exit can be specified by your installation. If this exit is installed, it may cause the Hardcopy utility's response to differ from the descriptions shown here. See *z/OS ISPF Planning and Customizing* for more information about the print utility exit.

Another factor that can affect the Hardcopy utility's performance is whether the TSO/E Information Center Facility is installed. If the TSO/E Information Center Facility is installed, your installation can optionally allow ISPF to display a panel for submitting TSO/E Information Center Facility information with the print request. See "Using the TSO/E information center facility" on page 187 for more information.

If the TSO/E Information Center Facility is not installed, the Hardcopy utility first displays the panel shown in Figure 111.

```

Menu  RefList  Utilities  Help
-----
                          Hardcopy Utility
                          More:      +
Process option  -  1. Print and keep data set or member
                  2. Print and delete sequential data sets

Data Set Name  . . . _____
Volume Serial  . . . . . _____ (If not cataloged)
Data Set Password . . . _____ (If password protected)

Print Mode . . . . . BATCH          (Batch or Local)

Batch Sysout class . . . _____ (BATCH only)
Local printer ID or
writer-name . . . . . _____ (LOCAL only)
Local Sysout class . . . _____ (LOCAL only)

Job statement information: (If not to local printer/external writer, verify
before proceeding)
Command ==>
F1=Help      F2=Split    F3=Exit      F7=Backward  F8=Forward  F9=Swap
F10=Actions  F12=Cancel
    
```

Figure 111. Hardcopy Utility panel - before JCL generation (ISRUHCP)

Hardcopy utility panel action bar

The Reset ISPF Statistics panel action bar choices function as follows:

Menu For more information, see the details about the Menu Action Bar Choice in the ISPF User Interface topic in the *z/OS ISPF User's Guide Vol I*.

RefList

For information about referral lists, see the topic about Using Personal Data Set Lists and Library Lists in the *z/OS ISPF User's Guide Vol I*.

Utilities

For more information, see the details about the Utilities Action Bar Choice in the ISPF User Interface topic in the *z/OS ISPF User's Guide Vol I*.

Help The Help pull-down offers these choices:

- 1 General
- 2 Function of the hardcopy utility
- 3 Selecting a print mode
- 4 Submitting a background job to print a data set or member
- 5 Routing a data set to a printer local to your terminal group
- 6 Printing a data set using TSO/E Information Center Facility
- 7 Appendices
- 8 Index

Hardcopy utility panel fields

The Data Set Name, Volume Serial, Data Set Password, and Job statement information fields, shown in Figure 111 on page 184, are explained in the "ISPF Libraries and Data Sets" chapter of the *z/OS ISPF User's Guide Vol I*. The other fields on the panel are:

Print Mode

Lets you specify one of these print modes:

BATCH

Submits your print request as a background job.

LOCAL

Routes your data to a local printer, such as an IBM 328x printer that is connected to your terminal group.

Batch Sysout Class

Destination of printed data set. Used only if the data set is to be printed and Batch SYSOUT class is specified.

Local Printer ID or Writer name

Destination of printed data set. Used only if the data set is to be printed and Local Printer ID or external writer name is specified.

Note: If you specify a Local Printer ID or writer name and you have selected the Edit PRINTDS Command option on the ISPF Settings panel (option 0), ISPF displays the Local Print Command Edit panel to allow you to intercept and edit the PRINTDS command before it is processed. For more information on editing the PRINTDS command, see the "ISPF Libraries and Data Sets" chapter in the *z/OS ISPF User's Guide Vol I*.

Local Sysout Class

Used in conjunction with the Local Printer ID or Writer Name. Specifies the output class to use for output processing.

Generating and submitting JCL

Follow these steps to generate and submit JCL for your print jobs:

1. Choose one of the options listed at the top of the panel and type its code, 1 (for PK) or 2 (for PD), in the Option field.
2. Specify a fully qualified data set name and member name.

Hardcopy utility (option 3.6)

This is a required field. If you are entering a fully qualified TSO data set name, you must enclose the name in quotes. If you omit the quotes, the data set prefix from your TSO user profile is automatically added to the beginning of the data set name.

3. If the data set is not cataloged, specify the volume serial.
4. If your data set is password protected, type the password in the Data Set Password field. For more information on data set passwords, see the "ISPF Libraries and Data Sets" chapter of the *z/OS ISPF User's Guide Vol I*.
5. Specify either BATCH or LOCAL in the Print Mode field.
6. Specify one of these:
 - If you chose BATCH in the previous step, type a Batch SYSOUT class and any job statement information you need.
 - If you chose LOCAL in the previous step, type the name of a local printer or writer name in the Local Printer ID field. Job statement information is ignored.
7. Press Enter.

What happens next depends on your choice in step 5. If you chose BATCH, see step 7a. If you chose LOCAL, see step 7b on page 187.

- a. If you chose BATCH, ISPF generates the JCL and displays the panel shown in Figure 112, with the message JCL generated in the upper-right corner.

```
Menu  RefList  Utilities  Help
-----
                        Hardcopy Utility                      JCL generated
                                                                More:      +
Process option  1  1. Print and keep data set or member
                  2. Print and delete sequential data sets
                  3. Exit without submitting job

Enter End command to submit job.

Data Set Name . . 'MYPROJ.DEV.SOURCE(TESTA)'
Volume Serial . . . . . (If not cataloged)
Data Set Password . . . . . (If password protected)

Batch Sysout class . . . A
Print Mode . . . . . : BATCH (Batch or Local)
Local printer ID or
writer-name . . . . . :
Local Sysout class . . . :

Job statement information:
Command ==>>
F1=HELP      F2=          F3=END      F4=DATASETS  F5=FIND      F6=CHANGE
F9=SWAP      F10=LEFT     F11=RIGHT  F12=SUBMIT
```

Figure 112. Hardcopy Utility panel - after JCL generation (ISRUHCJP)

At this point you can either:

- Cancel the job by typing the CANCEL command in the Option field and pressing Enter.
- Submit the job by typing the END command and pressing Enter. ISPF displays this message at the bottom of the panel:

```
IKJ56250I JOB useridA(JOBnnnnn) SUBMITTED
***
```

Press Enter. For more information about BATCH printing, see “Additional batch printing information.”

- Specify another data set name for printing.
- b. If you chose LOCAL, ISPF calls the PRINTDS TSO command processor to print the data set on the specified local printer.
- A message is displayed in the short message area to show that PRINTDS has accepted the request. At this point, you can:
- Specify another option and press Enter
 - Enter the END command
 - Enter the CANCEL command
8. If you entered CANCEL or END, ISPF determines the next panel you see as follows:
- If you entered the Hardcopy utility from the ISPF Primary Option Menu or through the jump function (=), ISPF displays the ISPF Primary Option Menu.
 - If you entered the Hardcopy utility from the Utility Selection Panel, ISPF returns you to that panel.

Additional batch printing information

When you enter the desired information and press Enter, ISPF generates JCL that contains the job statement operands and a job step that prints the specified data set, using the IBM IEBGENER utility.

Note:

1. IEBGENER does not support packed data. If you try to print packed data, you may get unwanted results. IEBGENER prints the data set one logical record per print line. If the logical record length is greater than the printer width, the logical record is truncated.
2. ISPF does not unpack data automatically before printing it. Therefore, if you need to unpack data before printing it, edit the data set and enter the PACK primary command with the OFF operand. See *z/OS ISPF Edit and Edit Macros* for more information about the PACK command.

Once the JCL for the first job step is generated, the job statement operands are shown for information aboutly. They are no longer highlighted and you cannot type over them, since the job statement has already been generated. You can then select another data set name to cause another job step to be generated.

Using the TSO/E information center facility

If the TSO/E Information Center Facility is installed, your installation can allow ISPF to display the panel shown in Figure 113 on page 188.

Hardcopy utility (option 3.6)

```

                                     Hardcopy Utility

Process option  1  1. Print and keep data set or member
                  2. Print and delete sequential data set

Data Set Name . . . . _____
Volume Serial . . . . _____ (If not cataloged)
Data Set Password . . _____ (If password protected data set)

Printer location . . _____

Printer format . . . _____

Number of copies . . _____

Command ==> _____
F1=HELP      F2=      F3=END      F4=DATASETS  F5=FOUND     F6=CHANGE
F9=SWAP      F10=LEFT  F11=RIGHT  F12=SUBMIT

```

Figure 113. Hardcopy Utility panel - with the TSO/E information center facility installed (ISRUHCPI)

Follow these steps to use the TSO/E Information Center Facility to submit your print jobs:

1. Choose one of the options listed at the top of the panel and type its code, PK or PD, in the Option field.
2. Enter a fully qualified data set name and member name.
You must specify at least the low-level qualifier, such as LIST. If you enter your user prefix as part of the data set name, you must enclose the complete data set name in quotes. However, if you omit the user prefix and quotes, your user prefix is automatically added to the beginning of the data set name.
3. If the data set is not cataloged, enter the volume serial.
4. If your data set is password-protected, enter the password in the Data Set Password field. For more information about data set passwords, see the "ISPF Libraries and Data Sets" chapter of the *z/OS ISPF User's Guide Vol I*.
5. You can either leave the Printer location field blank or enter the location ID of the printer to be used. The location ID is assigned by your installation.
You can also enter a partial location name followed by an asterisk (*).
6. You can either leave the "Printer format" field blank or enter the format ID of the printer to be used. The format ID is assigned by your installation.
You can also enter a partial format name followed by an asterisk (*). If your printer location and format entries do not identify a specific printer, a printer selection list is displayed. From this list, which is similar to a member selection list, you can select a printer.
7. Specify the number of copies you want.
8. Press Enter.

The values entered in the fields on this panel are passed directly to the TSO/E Information Center Facility for processing.

Download data set to workstation utility (option 3.7)

The Download Data Set to Workstation utility allows you to upload or download data sets from the host environment to your workstation. This utility is also used to download the WSA installation files needed to create a workstation connection.

Before you install the workstation utility:

Review the information in the topic "Installing the Client/Server component" in the *z/OS ISPF User's Guide Vol I* before you use this utility to install the WSA for the first time.

When you select option 7 from the Utility Selection Panel, ISPF displays the Download Data Set to Workstation panel (ISPUDL). This panel has two options:

1. Download the ISPF C/S component to your workstation
2. Download or upload an ISPF library, PDS or sequential data set

Download ISPF C/S component

This option enables you to download the ISPF Workstation Agent (WSA) component installation program to your desktop workstation. After downloading the WSA and installing it, you can use ISPF on a z/OS host through GUI windows on your workstation and use your workstation connection in distributed editing. See the topic "Installing the Client/Server component" in the *z/OS ISPF User's Guide Vol I* for a description of the download and installation processes.

When you select option 1 from the Download Data Set to Workstation panel, ISPF displays the ISPF Client/Server Component Download panel shown in Figure 114.

```

Client/Server Component Download

Download methods
  1. FTP (requires workstation FTP server)
-  2. ISPF C/S (requires workstation connection)
   3. Manual

Workstation Type
-  1. Windows 2000/NT          3. AIX          5. HP UX
   2. Reserved                4. Solaris

Directory to copy file to:
_____

Data Set to copy file from:
_____

Enter "/" to select option
  Create directory to which the file is to be copied.

Command ==> _____
F1=HELP      F2=_____  F3=END      F4=DATASETS  F5=FIND      F6=CHANGE
F9=SWAP      F10=LEFT   F11=RIGHT   F12=SUBMIT

```

Figure 114. ISPF Client/Server Component Download panel (ISPWSD01)

The Client/Server Component Download panel enables you to choose the download method and workstation type you want to use to put the WSA installation program on your desktop.

Download data set to workstation utility (option 3.7)

Client/Server Component Download panel

The Client/Server Component Download panel contains these fields:

Download methods

You have three choices for downloading the WSA installation program.

FTP (requires workstation FTP server)

Download using FTP. ISPF invokes the host FTP client to connect with the FTP server on your workstation and transfer the WSA installation program. This option can be used to download the WSA installation program for the first time. It is described in the topic "Installing the Client/Server component" in the *z/OS ISPF User's Guide Vol I*.

ISPF C/S (requires existing workstation connection)

Download using ISPF Client/Server. If you already have a workstation agent installed on your workstation, you can use the built-in file transfer services to download a new or updated WSA installation program. The file must be downloaded in binary format.

Manual

ISPF tells you the name of the file you need to copy. You can copy it with any method you prefer as long as you maintain the data integrity of the WSA installation program. The file must be downloaded in binary format. This option can be used to download the WSA installation program for the first time. It is described in the topic "Installing the Client/Server component" in the *z/OS ISPF User's Guide Vol I*.

Workstation type

The workstation agent runs on different workstation platforms and you must indicate which platform you have, so that you receive the correct version.

1. Windows 2000 or NT
2. Reserved
3. AIX®
4. Solaris
5. HP UX

Directory to copy file to

Specify a directory on your workstation where you want to store the WSA installation program. You can specify a full path name or a relative directory, or leave this field blank. If you leave it blank, the download is made to your home directory (in the case of FTP downloads) or the current directory (in the case of client/server downloads). If you specify a relative directory (one that does not start with a drive letter or slash character) the directory is relative to the FTP home directory or the client/server current directory.

Data set to copy file from

The host data set that contains the WSA installation program. This value varies depending on the naming convention that was used when ISPF was installed.

Create directory to which the file is to be copied

If you want ISPF to create the directory on your workstation before copying the WSA installation program, enter a "/" in this field.

ISPF client/server (c/s) download

When you select choice 2 “ISPF C/S (requires workstation connection)” under *Download methods* on the ISPF Client/Server Component Download panel, you are choosing to use the ISPF Client/Server method of downloading. This method is used to obtain updated versions of the WSA and can only be used if you have already installed and initiated the WSA and established a workstation connection. If this is the first time you are downloading the WSA, use the FTP or Manual methods of downloading, instead.

If you do not already have a workstation connection (with or without GUI display) established, ISPF displays the ISPF Client/Server Installation Notice panel shown in Figure 115.

```

-   ISPWSD03          Client/Server Installation Notice
I
1   A workstation connection is required to download a new Client/Server
2   component using workstation agent file transfer services.

   Do you wish to start a workstation connection now?
   - 1. Yes, start workstation connection now and continue with download
     - 2. No, do not start workstation connection

Command ==>
0   F1=Help      F2=Split      F3=Exit      F7=Backward  F8=Forward
F   F9=Swap      F12=Cancel

```

Figure 115. ISPF Client/Server Installation Notice (ISPWSD03)

The field on this panel is:

Do you wish to start a workstation connection now?

This field enables you to start a workstation connection directly from the panel. This assumes, of course, that you have a previous copy of the WSA installed on your workstation.

1. Yes, start workstation connection now and continue with download.

Select this option when you know you have a Workstation Agent installed and you have initiated it on your workstation.

2. No, do not start workstation connection

Select this option when you know that a prerequisite for establishing a workstation connection has not been met and you want to return to the Client/Server Component Download panel.

If you have already established a workstation connection (see “Initiate the workstation connection” on page 61) and you select this download method, the Client/Server transfer service is immediately invoked to copy the WSA installation program to your workstation. A successful transfer results in the panel shown in

Download data set to workstation utility (option 3.7)

Figure 116.

```
—
I
1  ISPF Client/Server Component Install Program
2  The ISPF Client/Server Component workstation install program has been
   copied to your workstation in directory:
   C:\TEMP
   in directory:
   End your workstation connection, close the active workstation agent,
   and complete the installation by running the install program ISPFINST
   on your workstation in the directory specified. The program is a self
   extracting executable that will result in additional files being
   generated on your workstation.
   Do you wish to end your workstation connection now?
   1. Yes, end workstation connection now
   2. No, do not end workstation connection now
Command ==>
0  F1=HELP      F2=      F3=END      F4=DATASETS  F5=FINN
   F6=CHANGE   F9=SWAP   F10=LEFT   F11=RIGHT   F12=SUBMIT
F
```

Figure 116. ISPF Client/Server Component Install Program panel (ISPWSD06)

Running the installation program (ISPFINST)

After you have downloaded the Workstation Agent Installation program, resume the installation by running the program called ISPFINST.EXE (ispfinst on UNIX platforms). This is a self-extracting executable program that generates additional necessary files on your workstation. See the topic "Installing the Client/Server component" in the *z/OS ISPF User's Guide Vol I* for a description of the Workstation Agent installation process.

Download/upload data set

The final option on the Download Data Set to Workstation (option 3.7) panel is called "Data Set — Download/upload ISPF library, partitioned, or seq data set". This option provides a panel-driven interface to the ISPF FILEXFER service, enabling you to transfer data between the host and the workstation. This is a manually controlled alternative to using the Workstation Tool Integration (see "Workstation tool integration" on page 68).

Selecting option 2 displays the panel shown in Figure 117 on page 193:

Download data set to workstation utility (option 3.7)

```
Menu RefList RefMode Help
-----
Download/Upload Data Set To/From Workstation

ISPF Library:
Project . . . MYPROJ
Group . . . DEV . . . . .
Type . . . SOURCE
Member . . . (Blank or pattern for member selection list)

Other Partitioned or Sequential Data Set:
Data Set Name . . .
Volume Serial . . . (If not cataloged)

Workstation File:
File Name . . . . .

Transfer Option                                Options
- 1. Download to workstation                    - Generate statistics on upload
- 2. Upload from workstation                    - Transfer in text mode
                                                - Replace existing member/file

Command ==>
F1=HELP    F2=          F3=END    F4=DATASETS  F5=FOUND    F6=CHANGE
F9=SWAP    F10=LEFT   F11=RIGHT F12=SUBMIT
```

Figure 117. ISPF data set panel (ISPUDLDS)

Use the Download or Upload selections to indicate whether you want to download host data to the workstation, or upload workstation data to the host. Enter 1 for “download to workstation”. Enter 2 for “upload from workstation”.

You can transfer data from either PDS or sequential host data sets. The host data set must exist before attempting a transfer, but a PDS member is created if it does not already exist. Workstation files need not exist before downloading data from the host, but the specified directory must be there.

For downloading only, you can specify an asterisk (*) character in the workstation file name. ISPF substitutes the member name of the data being downloaded for the *. This enables you to select multiple members from the member list to be downloaded as separate files.

“Generate Statistics on Upload” indicates whether ISPF member statistics should be generated when a workstation file is uploaded to a member of a PDS. Statistics are only generated when the host data set is record format F or V.

The “Transfer in Text mode” field determines whether the file transfer is done in text mode (with ASCII to EBCDIC translation) or in binary mode (without any translation). When transferring in text Mode, the ispf filexfer service provides a one-to-one mapping of all 256 code points between the host code page and the workstation code page. Most other file transfer utilities (for example, ftp) only provide a one-to-one mapping of displayable characters.

Outlist utility (option 3.8)

This utility gives you the ability to browse, print, delete, or requeue job output that is in a held SYSOUT queue. When you select this option, a panel is displayed (Figure 118 on page 194) that allows you to select an option and enter the appropriate operands.

Outlist utility (option 3.8)

```
Menu  Utilities  Help
-----
                                Outlist Utility
                                More:    +

L List job names/id(s) via the TSO STATUS command
D Delete job output from SYSOUT hold queue
P Print job output and delete from SYSOUT hold queue
R Requeue job output to a new output class
blank Display job output

For Job to be selected:
Jobname  . .  _____
Class    . . .  _
JobID    . . .  _____

For Job to be requeued:
New Output class  . .  _

For Job to be printed:
Printer Carriage Control  . .  _          (A for ANSI   )
                                                (M for machine )

Option ==>
F1=Help      F2=Split    F3=Exit    F7=Backward  F8=Forward  F9=Swap
F10=Actions  F12=Cancel
```

Figure 118. Outlist Utility panel (ISRUOLP1)

Outlist Utility panel action bar

The Outlist Utility panel action bar choices function as follows:

Menu For more information, see the details about the Menu Action Bar Choice in the ISPF User Interface topic in the *z/OS ISPF User's Guide Vol I*.

Utilities

For more information, see the details about the Utilities Action Bar Choice in the ISPF User Interface topic in the *z/OS ISPF User's Guide Vol I*.

Help The Help pull-down offers you these choices:

- 1 General
- 2 Listing the status of jobs
- 3 Deleting the output of a held job
- 4 Printing the output of a held job
- 5 Requeueing the output of a held job
- 6 Displaying the Output of a held job
- 7 Appendices
- 8 Index

Outlist Utility panel fields

The fields on this panel are:

Jobname

The held SYSOUT job. It is required for all options except option L.

Class The SYSOUT hold queue. If you omit the CLASS operand, all SYSOUT queues are searched for the specified job.

JobID Required only if more than one job exists with the same job name.

New Output class

When requeuing a job (option R), enter the new SYSOUT hold class here.

Printer Carriage Control

When printing a data set (option P), enter a value here that corresponds to the type of carriage control characters in the data set. Valid values are:

A If the data contains American National Standard Institute (ANSI) carriage control characters.

M If the data contains machine control characters.

Blank If the data contains no carriage control characters.

The record formats for the corresponding data sets are FBA, FBM, and FB, respectively.

Outlist utility options

These topics explain the options listed at the top of the Outlist Utility panel:

- “L — list job names/ID(s) via the TSO STATUS command”
- “D — delete job output from SYSOUT hold queue”
- “P — print job output and delete from SYSOUT hold queue”
- “R — requeue job output to a new output class” on page 196
- “Blank — display job output” on page 196

L — list job names/ID(s) via the TSO STATUS command

If you select option L, a list of job names and job IDs is displayed. If you leave the job name blank, or if the job name is your user ID plus one identifying character, the status is listed for all jobs having job names consisting of your user ID followed by that identifying character. If you supply any other job name, the status for that exact job is displayed.

The list of job names is displayed on the lower portion of the panel. If the list is too long to fit on the screen, three asterisks are displayed on the last line of the screen. You can display the remainder of the list by pressing Enter.

D — delete job output from SYSOUT hold queue

If you select option D, the held output for a specific job is deleted from the specified SYSOUT queue.

P — print job output and delete from SYSOUT hold queue

If you select option P, the held output for a specific job is removed from the SYSOUT queue and placed in an ISPF-defined data set for printing. You can choose the record format for this data set by putting an entry in the Printer Carriage Control field.

An optional print utility exit can be installed by your system programmer. If this exit is installed, it may cause the Outlist utility's response to differ from the descriptions provided here. See *z/OS ISPF Planning and Customizing* for more information about the print utility exit.

Another factor that can affect the performance of the Outlist utility is whether the TSO/E Information Center Facility is installed. If the TSO/E Information Center Facility is installed, your installation can optionally allow ISPF to display a panel for submitting the TSO/E Information Center Facility information with the print request. See Figure 185 on page 329 for an example of this panel and “Using the TSO/E information center facility” on page 187 for information about the fields on this panel.

Outlist utility (option 3.8)

If the TSO/E Information Center Facility is not installed, the Outlist utility displays the panel shown in Figure 184 on page 322 when you press Enter. Use this panel to tell ISPF how and where the job output is to be printed. This option does not honor multiple copies for output on hold queue. To print multiple copies use option R.

ISPF uses temporary data sets named *prefix.userid.SPFnnn.OUTLIST* (if your data set prefix in your TSO user profile is different from your TSO userid) or *userid.SPFnnn.OUTLIST* (if your prefix and userid are the same), where *nnn* is a number between 100 and 999.

Attention: If you keep or use all data sets through 999, ISPF resets to 100 and uses the existing data sets. Also, ISPF can use the data sets that you allocate using the temporary data set naming convention.

R — requeue job output to a new output class

If you select option R, the held output for a specific job is requeued to another SYSOUT class from the specified SYSOUT queue. You must enter the new SYSOUT class on the panel in the “New Output class” field. You can use this option to print output with multiple copies by requeuing to a SYSOUT class predefined to print multiple copies.

Blank — display job output

If you leave the Option field blank, the held output for the specified job is displayed in Browse mode. You can use all Browse commands. The data remains in the SYSOUT queue. When you enter the END or RETURN command to end Browse, the Outlist Utility panel is displayed again, and you can then choose to print, requeue, or delete the job output.

Command table utility (option 3.9)

The Command Table utility (option 3.9) enables you to create or change ISPF application command tables. When you select this option, a panel is displayed (Figure 119 on page 197) to prompt you for an application ID. The name of the command table is then derived by adding CMDS to the application ID. If the table exists in the table input library, ISPTLIB, it is displayed and can be modified. If the table does not exist in the table input library, a new table is generated.

The command table displays the search order of commands for a particular logical screen. The order is from top to bottom of those commands displayed. The “User table” and “Site table” fields are blank if no values are set for them in the ISPF Configuration table, or if values have been set but the tables do not exist in the “ISPTLIB” concatenation.

You cannot use this utility to change a command table that is currently in use. Command table ISPCMDS, the system command table, is always in use by the Dialog Manager component. If you enter ISP in the Application ID field, ISPF displays the ISPCMDS command table in read-only mode.

While you are using this utility to change a command table, the table cannot be used for other purposes. For example, you cannot use split screen and select a function with NEWAPPL(XYZ) if you are changing command table XYZCMDS.

```

Menu  Help
-----
I  ISPUCMA          Command Table Utility

1  Specifications          Command table search order
   Application ID . . . . . Application table . . : ISR
2  Enter "/" to select option
   - Show description field User table 1 . . . . . : USER
3                                     User table 2 . . . . . :
4                                     User table 3 . . . . . :
5                                     Site table 1 . . . . . : SITE
6                                     Site table 2 . . . . . :
7                                     Site table 3 . . . . . :
8                                     System table . . . . . : ISP
9
8  If no application ID is specified, the current application ID will be
9  used. The name of the command table to be processed is formed by
1  prefixing the application id to the string 'CMDS'. For example:
1  Application ID . . . TST results in a command table name of 'TSTCMDS'.
1
1  Command ===>
1  F1=Help      F2=Split      F3=Exit      F7=Backward  F8=Forward
0  F9=Swap      F12=Cancel

F10=Actions  F12=Cancel

```

Figure 119. Command Table Utility panel (ISPUCMA)

Command Table Utility panel fields

The fields on the Command Table Utility panel function as follows:

Application ID

Contains the name of an application for which you want to define commands.

Show description field

Allows you to display the descriptions as well as the commands and definitions.

The command table for the named application is displayed on a Command Table editing panel (Figure 120 on page 198). This panel can be scrolled up and down using the scroll commands.

Command table utility (option 3.9)

```
File Menu Utilities Help
-----
Update TSTCMDS                               Row 1 to 4 of 4

Insert (I), delete (D), repeat (R) and edit (E) command entries.
Enter END command to save changes or CANCEL to end without saving.

Verb      T  Action
-----
SORT      0  SELECT PGM(PQRSORT) PARM(&ZPARM)
PREPARE   4
QUIT      2  ALIAS END
EXPLAIN   4
***** Bottom of data *****

Command ==> _____ Scroll ==> PAGE
F1=Help    F2=Split   F3=Exit    F7=Backward F8=Forward F9=Swap
F10=Actions F12=Cancel
```

Figure 120. Command table editing panel (ISPUCMD)

The column headings on the panel are:

Verb The command verb, which is the name of the command you are defining in the command table. A command verb must be 2 to 8 characters long, inclusive, and must begin with an alphabetic character. The content of this column is assigned to the ZCTVERB system variable.

T (truncation)

The minimum number of characters that you must enter to find a match with the command verb. If this number is zero or equal to the length of the command verb, you must enter the complete command verb. For example, in Figure 120 the PREPARE command has a truncation value of 4. Therefore, for the TST application used as the example in the figure, only the first four letters, PREP, must be entered to call this command. The content of this column is assigned to the ZCTTRUNC system variable.

Action

The actual coding of the action to be carried out when you enter the command. The action length must not be greater than 240 characters. The content of this column is assigned to the ZCTACT system variable.

To enter or edit the coding for the action:

1. Enter the E command table line command to display the Extended Command Entry panel (ISPUCMX).
2. Type the required coding in the Action lines.

Normally, any text you type in lowercase is translated to uppercase before it is saved.

To define some of the parameters in lowercase select the **Allow mixed-case in Action field** option on the Extended Command Entry panel. The case of the text you type is not translated and is saved as you input it.

Note that when you select the **Allow mixed-case in Action field** option:

- a. The first word *must* be input in uppercase.
 - b. If you use &ZPARAM to obtain parameters from the command line, the parameters may be translated to uppercase (regardless of the setting of the **Allow mixed-case in Action** field option).
3. Optionally, type a brief description of the purpose of the command in the Description lines.
 4. Press PF3 to return to the Command Table Editing panel.

Note:

1. Do not use ACTIONS, CANCEL, CRETRIEV, CURSOR, EXIT, PRINT, PRINTG, PRINTHI, PRINTL, PRINTLHI, RESIZE, RETF, RETP, RETRIEVE, SPLIT, SPLITV, SWAP, WINDOW, or WS as keywords in the Action column. These keywords are intended only for use in the system command table distributed with ISPF. They are not intended for use in application command tables.
2. Take care with ACTIONs that use ZPARAM, as the ISPF parser will add a matching parenthesis if one appears to be missing. Consider an entry of "SELECT CMD(%CMD &ZPARAM) NEWAPPL(ISR)". If "(XYZ" is passed then the command will receive "(XYZ) NEWAPPL(ISR)" as a parameter.

The valid actions are:

SELECT

Causes the selected dialog (command, program, or selection panel) to be given control immediately. See *z/OS ISPF Dialog Developer's Guide and Reference* for more information about the SELECT statement and its keywords.

ALIAS

Allows one command verb to carry out the action defined for another. For example, in Figure 120 on page 198, QUIT is an alias for END. Therefore, for the TST application used as the example in the figure, entering QUIT causes the same action to occur as entering END.

An ALIAS command must be defined before the command for which it is an ALIAS.

PASSTHRU

Causes the command to be passed through to the dialog as if it had not been found in the command table.

SETVERB

Causes the command to be passed through to the dialog, with the command verb stored separately from the operands.

NOP Causes the command to be inoperative. An inactive command message is displayed.

Blank Causes the command table entry to be ignored. ISPF continues to search for additional entries for the same command verb. If the command is not found in either the application command table or the system command table, an invalid command message is displayed.

xxxxx A variable name, beginning with an ampersand (&), allows dynamic specification of the command action.

Command table utility (option 3.9)

DESCRIPTION

An optional, brief description of the action the command verb is to perform. Since this column is offset three spaces under the Action column, the description length must not be greater than 80 characters. The content of this column is assigned to the ZCTDESC system variable.

For a new table, this panel initially contains dummy entries with all fields shown as underscores. The underscores are pad characters and need not be blanked out. However, any null entries where at least the verb contains all underscores are automatically deleted when the table is saved.

Scrolling a command table

You can scroll the table entries, using the ISPF UP and DOWN scroll commands, and change one or more entries simply by typing over them.

Saving a command table

The END command causes the table to be saved in the table output library, ISPTABL, and ends the utility.

Canceling a command table

The CANCEL command ends the command table display without saving the table.

Using command table line commands

The line commands you can enter at the left of any entry (by typing over the four quotation marks) are described in these topics:

- "D — deleting lines"
- "E — editing lines"
- "I — inserting lines" on page 201
- "R — repeating lines" on page 201
- "V — viewing lines" on page 201

Multiple line commands or changes can be entered in a single interaction. Line commands followed by a number, such as D3, are repeated that number of times. The lines are processed in the order in which they appear on the screen. Any line commands or changes that are entered concurrently with the END command are processed before the table is saved.

D — deleting lines

The D command deletes one or *n* lines



```
»-D- [ 1 - n ]----->>
```

E — editing lines

The E command displays the Extended Command Entry panel (ISPUCMX) where you can edit the action and description fields for a line.



```
»-E----->>
```

I — inserting lines

The I command inserts one or n lines.

► I $\left[\begin{array}{c} 1 \\ n \end{array} \right]$ _____ ►

The inserted lines contain underscores (pad characters) in all field positions.

R — repeating lines

The R command repeats a line one or n times. The repeated lines contain underscores (pad characters) in the Verb and T (truncation) fields, but the Action and Description fields are copied from the line on which the R command was entered.

► R $\left[\begin{array}{c} 1 \\ n \end{array} \right]$ _____ ►

V — viewing lines

The V command views one or n lines. You can look at the entire command entry including the command action and description fields, but you cannot change them.

► V $\left[\begin{array}{c} 1 \\ n \end{array} \right]$ _____ ►

Format specifications utility (option 3.11)

The Format Specifications utility (option 3.11) is provided to support the IBM 5550 terminal using the Double-Byte Character Set (DBCS). It is used to maintain formats that are used when viewing, browsing, and editing to display data sets that contain predefined formatted records.

The purpose of a format is to structure data from a record into fields, and to define the order these fields are to be physically displayed on the screen when you are viewing, browsing, and editing.

When you select this option, a panel is displayed (Figure 121 on page 202) that allows you to add, copy, delete, or update a format. You can also display the format list.

Format specifications utility (option 3.11)

```
Menu Utilities Help
-----
                          Format Specifications
                                          More:  +

A          Add a new format
C          Copy formats
D          Delete a format
U          Update format
L or BLANK Display format list

Format Name . . . _____

For COPY operations, specify the following:

From Format . . . _____ (Blank for format list, * for all formats)

From Table . . . _____ (Default is "ISRFORM" )

Note: The Format Utility is provided for support of the IBM 5550 terminal
Option ===>
F1=Help   F2=Split   F3=Exit   F7=Backward F8=Forward F9=Swap
F10=Actions F12=Cancel
```

Figure 121. Format Specifications panel (ISRFORM01)

Format Specifications panel action bar

The Format Specifications panel action bar choices function as follows:

Menu For more information, see the details about the Menu Action Bar Choice in the ISPF User Interface topic in the *z/OS ISPF User's Guide Vol I*.

Utilities

For more information, see the details about the Utilities Action Bar Choice in the ISPF User Interface topic in the *z/OS ISPF User's Guide Vol I*.

Help The Help pull-down introduces formats and provides information about how to add, copy, delete, update, and display formats.

Format Specifications panel fields

The fields on this panel are:

Format Name

The name of the format that you want to add, delete, or update. When copying a format (option C), this is the name you want the copied format stored under.

From Format

When copying a format (option C), you can:

- Enter the name of a format you want to copy
- Enter an asterisk (*) to copy all formats
- Leave the field blank to display a copy format selection list.

See Figure 123 on page 205 for an example of a Copy Format Selection List display.

From Table

When copying a format (option C), you can:

- Enter the name of a table from which you want to copy a format
- Leave the field blank if you want to copy a format from the ISRFORM table.

Note: The ISRFORM table is the default location in which all of your user-defined formats are stored. If you have not yet defined any formats, this table will be empty.

Format Specifications panel options

These topics describe the options shown at the top of the Format Specifications panel:

- “A — add a new format”
- “C — copy formats” on page 204
- “D — delete a format” on page 205
- “U — update a format” on page 205
- “L or BLANK — display format list” on page 205

A — add a new format

If you specify option A and a format name, the Format Definition panel (Figure 122) is displayed.

Format Definition (FORM01) More: +

Field Number	Start Column	Field Length	Field Type	Field Number	Start Column	Field Length	Field Type
1	00000	00	-	2	00000	00	-
3	00000	00	-	4	00000	00	-
5	00000	00	-	6	00000	00	-
7	00000	00	-	8	00000	00	-
9	00000	00	-	10	00000	00	-
11	00000	00	-	12	00000	00	-
13	00000	00	-	14	00000	00	-
15	00000	00	-	16	00000	00	-
17	00000	00	-	18	00000	00	-
19	00000	00	-	20	00000	00	-

Field Number: Identifies the field position on the screen.
 Start Column: From 1 to 32760; Specifies column position in the record.
 field Length: From 1 to 71; Fields must not overlap.
 Field Type :E - single-byte, D - double-byte, M - mixed data

Enter the END command to exit and save the format.
 Command ==>>>
 F1=Help F2=Split F3=Exit F9=Swap F12=Cancel

Figure 122. Format Definition panel (ISRFORM02)

A field definition includes:

Field Number

The number of the field for which you are defining a format. You can define up to 20 fields.

Start Column

Starting column position in the record.

Field Length

Field length in bytes; the maximum is 71 bytes.

Format specifications utility (option 3.11)

Field Type

The type of data that can be entered in the field. Valid types are:

- E** EBCDIC (single-byte)
- D** DBCS (double-byte)
- M** Mixed data

Note: All three of these field types can contain extended graphics characters. CAPS ON processing is not possible because of context dependencies. Therefore, it is ignored when you are editing formatted data.

The format definition information applies to both existing records and inserted records in a data set.

Note: It is recommended that you avoid using STD or COBOL formats with numbered data. The results can be different from using formats with unnumbered data. If you must use numbered data, do not define the columns the sequence numbers will appear in, or define an EBCDIC or mixed data field for them.

C — copy formats

If you specify option C on the Format Specifications panel:

- If you specify both an asterisk (*) in the From Format field and a table name other than ISRFORM in the From Table field, all formats stored in the “From” table are copied to ISRFORM.

Note: If you specify a table name in the From Table field, and that table does not have the same format as ISRFORM, a severe error occurs.

- If you specify both a format name and a “From” format, the format is copied. If you specified a “From” table (other than ISRFORM), the format is copied from that table. Otherwise, the format is copied from ISRFORM. The Format Definition panel for the newly created format, containing the currently defined fields, is displayed. You can add, delete, and update field definitions. When you enter the END command, the format definition is stored in ISRFORM under the format name you specified.
- If you specify a format name but no “From” format, the Copy Format Selection List panel (Figure 123 on page 205) is displayed.

If you did not specify a “From” table, the formats listed are those stored in ISRFORM, the default format table. Otherwise, the formats listed are those stored in the table you specified.

Note: The ISRFORM table is the default location in which all of your user-defined formats are stored. If you have not yet defined any formats, the table will be empty and you will receive a “No formats found” message.

You can select a format to copy by entering the S line command to the left of that format name. Other commands you can enter are U (Update), R (Rename), D (Delete), SELECT (which is similar to S), SORT, and LOCATE. See “Format selection list commands” on page 206 for a description of these commands.

The format is copied, and the Format Definition panel for the newly created format, containing the currently defined fields, is displayed. You can add, delete, and update field definitions. When you enter the END command, the format definition is stored in ISRFORM under the format name you specified on the Format Specifications panel.

- If you specify neither a format name nor a “From” format, but you do specify a “From” table (other than ISRFORM), the Copy Format Selection List panel is displayed. You can select one or more formats to copy by entering the S line

Format specifications utility (option 3.11)

command to the left of each format names. Each of these formats is copied under the same name from the specified "From" table to the ISRFORM table.

Note: If you do not specify option C but specify a name in the From Format field, the From Format field is ignored.

```
Copy Format Selection List (ISRFORM) Row 1 to 4 of 4
Name      Rename    Created   Last Modified   ID
COMMON01          02/11/19 02/11/19 11:08   USERID
COMMON02          02/11/19 02/11/19 11:16   USERID
COMMON03          02/11/19 02/11/19 11:16   USERID
COMMON04          02/11/19 02/11/19 11:16   USERID
***** Bottom of data *****

:
Command ==> _____ Scroll ==> PAGE
F1=Help      F2=Split    F3=Exit     F7=Backward  F8=Forward  F9=Swap
F12=Cancel
```

Figure 123. Copy Format Selection List panel (ISRFM04)

D — delete a format

If you specify option D and a format name on the Format Specifications panel, the format is deleted.

U — update a format

If you specify option U and a format name on the Format Specification panel, the Format Definition panel containing the currently defined fields is displayed. You can add, delete, and update field definitions.

L or BLANK — display format list

If you specify option L or leave the Option line blank on the Format Specifications panel, the Format Selection List panel (Figure 124) is displayed.

```
Format Selection List Row 1 to 4 of 4
Name      Rename    Created   Last Modified   ID
COMMON01          02/11/19 02/11/19 11:08   USERID
COMMON02          02/11/19 02/11/19 11:16   USERID
COMMON03          02/11/19 02/11/19 11:16   USERID
COMMON04          02/11/19 02/11/19 11:16   USERID
***** Bottom of data *****

:
Command ==> _____ Scroll ==> PAGE
F1=Help      F2=Split    F3=Exit     F7=Backward  F8=Forward  F9=Swap
F12=Cancel
```

Figure 124. Format Selection List panel (ISRFM03)

Format selection list commands

These topics describe the commands you can use on a Format Selection List panel:

- "Locating format names"
- "Renaming a format"
- "Sorting format names"
- "Updating or selecting a format" on page 207

Deleting a format

If you specify the D line command beside a format name, the format is deleted.

Locating format names

The LOCATE command is another useful tool, especially if you have a long format list. To use the LOCATE command, ensure that the list is sorted by name. Next, enter the LOCATE command on the Command line. The syntax is:

```
▶▶—LOCATE—name—————▶▶
```

where:

name

The name of the format you want to find.

For example, this command would find a format named FORM03:

```
LOCATE FORM03
```

If the format exists, the entry for the specified format name appears as the second line following the header lines. If the specified name is not found, the existing format name that would immediately precede the specified name appears as the first line following the header lines.

Renaming a format

If you specify the R line command beside a format name, you must also specify its new name in the Rename field before you press Enter. If you do not, the Enter required field message appears in the upper-right corner of the screen and the cursor moves to the Rename field.

Sorting format names

You can sort the name list on this panel by entering the SORT command on the Command line. The syntax of the SORT command is:

```
▶▶—SORT—

|      |
|------|
| NAME |
| TIME |

—————▶▶
```

where:

NAME

Sort by name.

TIME

Sort by time last modified.

For example, this command would sort a format selection list by time:

```
SORT TIME
```

Updating or selecting a format

If you specify the U or S line command beside a format name, the Format Definition panel containing the currently defined fields is displayed. You can add, delete, and update field definitions.

You can specify that multiple operations be done at the same time. However, if you specify U or S with other line commands, any commands after the first U or S are ignored.

The SELECT command provides you with another way to specify a format. This command is entered on the Command line.

The syntax of the SELECT command is:

```
►—SELECT—name—————►
```

where:

name

The name of the format you want to select.

If the format exists, the Format Definition panel containing the currently defined fields is displayed. You can add, delete, and update field definitions.

If no format exists for that name, a new format is created, and the Format Definition panel is displayed to allow you to define fields.

SuperC utility (option 3.12)

Note: For an introduction to the SuperC and SuperCE utilities (options 3.12 and 3.13), see Appendix A, “SuperC reference,” on page 457.

The SuperC utility (option 3.12) is a dialog that uses the SuperC program to compare data sets of unlimited size and record length at the file, line, word, or byte level. The panel shown in Figure 125 on page 208 is used to specify the name of a new data set.

Note: In this context, a *new* data set is an updated version of a previously created data set, such as a data set in your private library that has been modified but has not yet been promoted.

SuperC utility (option 3.12)

```
Menu  RefList  Utilities  Help
-----
SuperC Compare Utility - New Data Set

Specify "New" Data Set to be compared, then press the ENTER key.      More:      +

Project . . . _____
Group . . . . _____ . . . . _____ . . . . _____
Type . . . . _____
Member . . . _____ (Blank or pattern for member selection list,
                        "*" for all members)

"New" Other Partitioned, Sequential or VSAM Data Set:
Data Set Name . . . _____
Volume Serial . . . _____ (If not cataloged)

Profile DS Name . . . _____
Data Set Password . . _____ (If New data set password protected)

Enter "/" to select option      Execution Mode      Output Mode
- Mixed Mode                    1 1. Foreground    1 1. View
- Bypass selection list        2. Batch           2. Browse
Command ==>
F1=Help      F2=Split      F3=Exit      F7=Backward  F8=Forward  F9=Swap
F10=Actions  F12=Cancel
```

Figure 125. SuperC Utility panel (ISRSSNEW)

This panel requires only the names of the input data sets and a foreground or batch mode setting.

Note: For DBCS searches and compares to function properly, ISPF must be invoked with the JAPANESE keyword, on a terminal that supports DBCS, and the MIXED process option must be supplied to SuperC.

SuperC Compare Utility panel action bar

The SuperC Utility panel action bar choices function as follows:

Menu For more information, see the details about the Menu Action Bar Choice in the ISPF User Interface topic in the *z/OS ISPF User's Guide Vol I*.

RefList

For information about referral lists, see the topic about Using Personal Data Set Lists and Library Lists in the *z/OS ISPF User's Guide Vol I*.

Utilities

For more information, see the details about the Utilities Action Bar Choice in the ISPF User Interface topic in the *z/OS ISPF User's Guide Vol I*.

Help The Help pull-down provides general information about SuperC topics, as well as information about specifying the data sets and options and interpreting listings.

SuperC Compare Utility panel fields

All the fields on this panel are explained in the "ISPF Libraries and Data Sets" chapter of the *z/OS ISPF User's Guide Vol I*, except:

Profile DSN

The name of an optional data set that can contain a compare type, listing type, sequence numbers setting, Browse setting, process options, and process statements. All these elements, when combined in one data set or

member, are called a *profile*. See “Profiles and defaults - activate profiles and defaults” on page 226 for information about using the SuperCE utility (option 3.13) to create a profile data set.

The listing type and sequence numbers setting of the profile are copied onto the panel used to specify the old data set name (Figure 126 on page 210), but can be typed over or blanked out. However, other elements of the profile are in effect, even though they are not shown on the panel.

Mixed Mode

Select this field to have SuperC scan and parse the input data set lines for DBCS text strings.

Note: Mixed Mode is not valid for the File or Byte compare.

Bypass Selection List

When a member pattern is entered in the PDS Member List field or the member name portion of the data set field (such as MY.DATA.SET(pattern)), selecting this field causes SuperC to process all members matching that pattern without displaying a member selection list. Leaving this field blank causes the member list to be displayed.

Execution Mode

The processing mode you want to use when comparing the data sets. Choose one of these:

- 1 **Foreground.** After the old data set panel and member selection, if any, are completed, foreground mode compares the new and old data sets and stores the results in the data set specified in the **Listing DS Name** field, which you can browse at the terminal.
- 2 **Batch.** After the old data set panel and the member list, if any, are completed, batch mode causes the display of the SuperC Utility - Submit Batch Jobs panel, so you can specify job card and print disposition information or edit the JCL. Then, the batch job is submitted to compare the new and old data sets. See “Submitting a SuperC job in batch mode” on page 214 for more information.

Note: You cannot specify a data set password in batch mode. If your data sets are password protected, use foreground mode.

Output Mode

The output mode you want to use when displaying the listing file. Choose one of these:

- 1 **View.** This enables the listing file to be displayed in *view* mode. All View functions are enabled in this mode.
- 2 **Browse.** This enables the listing file to be displayed in the *browse* mode. All Browse functions are enabled in this mode.
- 3 **Eview.** This option only appears on non-English panels. It operates exactly the same as View except that Superc is invoked with an English language constants module. All titles and headings are in English. This facilitates use of hilighting of Superc listings on non-DBCS terminals.

When you complete the New Data Set panel and press Enter, ISPF displays the panel shown in Figure 126 on page 210. Of the five fields shown at the bottom of the panel (Volume Serial, Listing DS Name, Data Set Password, Listing Type, and Sequence Numbers), all except Listing Type may not appear, depending on the

SuperC utility (option 3.12)

mode you choose (foreground or batch) and the contents of the profile data set. Also, if you request a member list or specify an asterisk (*) in the Member field on the new data set panel, ISPF does not display a Member field on the old data set panel.

Note: In this context, an *old* data set is a base version of a data set, such as a data set in a production library.

```
Menu  RefList  Utilities  Help
-----
                          SuperC Compare Utility - Old Data Set

Specify "Old" Data Set to be compared, then press the ENTER key to compare to
"New" Data set . . . MYPROJ.DEV.SOURCE

Project . . . MYPROJ
Group . . . TEST . . . _____ . . . _____ . . . _____
Type . . . SOURCE
Member . . . _____

"Old" other Partitioned, Sequential or VSAM Data Set:
Data Set Name . . . _____
Volume Serial . . . _____ (If not cataloged)

Listing DS Name . . . SUPERC.LIST
Data Set Password . . . _____ (If Old data set password protected)

Listing Type . . . 1 1. Delta  2. CHNG  3. Long  4. OVSUM  5. Nolist

Command ==>
F1=Help    F2=Split    F3=Exit    F7=Backward  F8=Forward  F9=Swap
F10=Actions F12=Cancel
```

Figure 126. SuperC Utility - Old Data Set panel (ISRSSOLD)

Specify the name of an old data set. The type of old data set that you can specify depends on the type of new data set you specified on the previous panel. For example, you can compare:

- A complete new PDS to a complete old PDS
- A new sequential data set to:
 - An old sequential data set
 - An old membered PDS
- A new membered PDS to an old sequential data set.

In this context, the term *membered PDS* refers to a PDS for which a single member has been specified, such as:

```
'USERID.TEST.SCRIPT(NEWDATA)'
```

SuperC treats a membered PDS as a sequential data set because the comparison is done on a one-to-one basis. However, SuperC cannot compare a sequential data set to a complete PDS because it cannot compare one data set to more than one member of another data set.

When you press Enter, ISPF either displays a member selection list or begins the comparison. All the fields on this panel are explained in the "ISPF Libraries and Data Sets" chapter of the *z/OS ISPF User's Guide Vol I*, except:

Update DS Name

Tells SuperC the name of the data set that will contain column-oriented results of the comparison.

Note: This field is not displayed unless your profile data set contains an update (UPDxxxx) process option.

This data set is normally used as input to post processing programs and can be specified in addition to the normal listing data set. See the Process Options selection in "Process options - select process options" on page 224 for information about the SuperC process options.

If you leave this field blank, SuperC uses this default name:

prefix.userid.SUPERC.UPDATE

where *prefix* is your TSO prefix and *userid* is your user ID. If your prefix and user ID are identical, only your prefix is used. Also, if you do not have a prefix, only your user ID is used.

Note: If the ISPF configuration table field USE_ADDITIONAL_QUAL_FOR_PDF_DATA_SETS is set to YES, an additional qualifier defined with the ISPF_TEMPORARY_DATA_SET_QUALIFIER field is included before the SUPERC qualifier.

If you enter a fully qualified data set name SuperC uses it as specified. Otherwise, SuperC only appends your TSO prefix to the front of the data set name specified. If you run with TSO PROFILE NOPREFIX, SuperC uses the name as you entered it, which can result in an attempt to catalog the name in the master catalog.

If you enter the name of a data set that already exists, the contents of that data set are replaced by the new update output.

If you enter the name of a data set that does not exist, SuperC allocates it for you. The data set is allocated as a sequential data set unless you enter a member name after it, in which case it is allocated as a partitioned data set.

Note: For the UPDMVS8, UPDCMS8, UPDSEQ0, and UPDPDEL process options, the update data set contains valid data but only after a successful compare when differences are detected. The data set is always empty after a comparison that shows the data sets or members being compared have no differences.

Listing Type

The type of listing you want SuperC to create when it compares the data sets. This is a required field, so you must choose one of the listing types shown here. See Appendix B, "Understanding the listings," on page 505 for sample listings.

DELTA

Lists the differences between the source data sets, followed by the overall summary.

CHNG

Lists the differences between the source data sets, plus up to 10 matching lines before and after the differences. This listing is a variation of the DELTA listing; the matching lines before and after help you recognize changed areas of the source data sets.

LONG

Lists all the new data set source lines, plus old data set deleted lines. Both inserted and deleted lines are flagged.

SuperC utility (option 3.12)

OVSUM

Lists only the overall summary of the comparison. However, a PDS comparison generates an individual summary line for each PDS member.

NOLIST

Produces no listing output. In foreground mode, only a message is returned to show the outcome of the compare.

Listing DS Name

The name of the list data set to which SuperC writes the results of the comparison. However, if you enter NOLIST in the Listing Type field, SuperC does not create an output listing, so this name is ignored. Also, if you chose batch mode, this field does not appear on the panel. The SuperC Utility - Submit Batch Jobs panel is used instead.

If you leave this field blank, SuperC allocates a list data set, using default data set attributes and this data set name:

```
prefix.userid.SUPERC.LIST
```

where *prefix* is your TSO prefix and *userid* is your user ID. If your prefix and user ID are identical, only your prefix is used. Also, if you do not have a prefix, only your user ID is used.

Note: If the ISPF configuration table field USE_ADDITIONAL_QUAL_FOR_PDF_DATA_SETS is set to YES, an additional qualifier defined with the ISPF_TEMPORARY_DATA_SET_QUALIFIER field is included before the SUPERC qualifier.

If you enter a fully qualified data set name SuperC uses it as specified. Otherwise, SuperC only appends your TSO prefix to the front of the data set name specified. If you run with TSO PROFILE NOPREFIX, SuperC uses the name as you entered it, which can result in an attempt to catalog the name in the master catalog.

If you enter the name of a data set that already exists, the contents of that data set are replaced by the new output listing. However, if the data set is sequential, you can add this listing to the data set instead of replacing it by including the APNDLST process option in your profile data set.

If you enter the name of a data set that does not exist, SuperC allocates it for you. The data set is allocated as a sequential data set unless you enter a member name after it, in which case it is allocated as a partitioned data set.

Sequence Numbers

A value that tells SuperC whether to exclude sequence number fields from its comparison of your data sets. This field is not displayed if the compare type is FILE or BYTE. You can choose one of these:

blank Exclude Sequence Number fields from the comparison if the data set is F 80 or V 255 and the compare type is
Line

Otherwise, treat as data.

SEQ Exclude Sequence Number fields from the comparison. Sequence numbers are assumed in columns 73-80 in F 80 and in columns 1-8 in V 255 data sets.

NOSEQ

Treat F 80/V 255 standard sequence number columns as data.

COBOL

Ignore columns 1-6 in F 80 data sets. Data in columns 1-6 is assumed to be sequence numbers.

SuperC member lists

The panel shown in Figure 127 is displayed after you specify the old data set name, but only if all these statements are true:

- The new data set is partitioned.
- The Member field, shown on the SuperC Utility panel (see Figure 125 on page 208), or the PDS Member List field, shown on the SuperCE Utility panel (see Figure 130 on page 218) was left blank or a pattern was used, and Bypass Selection List was not selected. For more information on Displaying Member Lists, see the “ISPF Libraries and Data Sets” chapter of the *z/OS ISPF User’s Guide Vol I*.
- The profile data set or statements data set being used does not contain any SELECT process statements.

<u>M</u> enu	<u>F</u> unctions	<u>U</u> tilities	<u>H</u> elp			
COMPARE		USERID.COPYBOOK		Row 00001 of 00027		
Enter END command to process selections or CANCEL to leave the member list. Enter Old member(Oldmem) name if it is different from New member(Newmem) name.						
Newmem	Oldmem	Size	Created	Changed	ID	
. BIGCHAR		4	2001/06/29	2002/02/25 10:42:27	USERID	
. BIGKSDS		3	2001/08/10	2001/08/10 13:15:59	USERID	
. CONVT1		24	2001/06/18	2001/06/18 16:04:26	USERID	
. COPYCONC		12	2001/07/05	2001/07/05 17:33:41	USERID	
. COPYMM		2	2001/06/11	2001/06/11 10:57:01	USERID	
. COPY01		9	2001/02/24	2001/06/13 16:09:28	USERID	
. COPY0102		15	2000/05/11	2001/06/11 11:08:49	USERID	
. COPY02		7	2001/02/24	2001/02/24 17:09:50	USERID	
. DITTST1		27	2001/06/13	2001/06/13 10:38:16	USERID	
. FLMLDATE		443	2001/12/12	2001/12/12 12:41:44	USERID	
. FLMUDU		415	2001/12/10	2001/12/10 20:44:55	USERID	
. FMNCCPY1		35	2000/10/18	2002/09/10 17:18:42	USERID	
. FMNCCPY2		35	2000/10/18	2002/09/10 17:19:11	USERID	
Command ==>				Scroll ==> PAGE		
F1=Help	F2=Split	F3=Exit	F5=Rfind	F7=Up	F8=Down	F9=Swap
F10=Left	F11=Right	F12=Cancel				

Figure 127. SuperC member list panel (ISRSSML)

The members displayed in this list are members in the new data set. If the OLDMEM column is blank, SuperC assumes each member in the new data set is to be compared with a member of the same name in the old data set.

If you enter a member name in the OLDMEM column, SuperC compares this member to the one listed beside it in the NEWMEM column.

To compare your selections, enter the END command. If you have not selected any members, ISPF returns you to the previous panel.

To cancel your selections, enter either:

SuperC utility (option 3.12)

- The RESET command to remove all unprocessed selections without ending the member list display
- The CANCEL command to end the member list display without processing selections that are still on the screen.

Note: Both the jump function (=) and the RETURN command cause an implied cancellation of selections before they are carried out.

For more information about member lists, see the Using Member Selection Lists section of the “ISPF Libraries and Data Sets” chapter of the *z/OS ISPF User’s Guide Vol I*.

Submitting a SuperC job in batch mode

If you selected Batch Mode (2) on the SuperC Utility panel, the panel shown in Figure 128 is displayed before the job is submitted. This panel allows you to specify one of these:

- The SYSOUT class, which determines the printer to which your job is sent and the format used for the printed output.
- The name of a listing data set.
- Output data definitions that you can use to give the printer additional instructions, such as an output destination that is not defined by a SYSOUT class.

```
SuperC Utility - Submit Batch jobs                                     More:  +
Press ENTER to continue submit

Enter "/" to select option          Generate Output Type:
/_ Edit JCL before user submit      1  1. SYSOUT Class
                                     2  2. Data Set Name
                                     3  3. //OUTDD DD

SYSOUT Class . . . . A_____
Data Set Name . . . . _____
//OUTDD DD . . . . ._____
// . . . . ._____
                                LRECL for the Listing Output will be 133

Job statement information: (Required - Enter/Verify JOB control statement)

====> _____
====> _____
====> _____
Command ====> _____
F1=Help   F2=Split   F3=Exit   F7=Backward F8=Forward F9=Swap
F12=Cancel
```

Figure 128. SuperC Utility - Submit Batch Jobs panel (ISRSCSUB)

The “Job statement information” field is explained in the Job Statement Information section of the “ISPF Libraries and Data Sets” chapter of the *z/OS ISPF User’s Guide Vol I*. The other fields on the panel shown in Figure 128 are:

SYSOUT class

A system output classification defined by your installation, which defines certain print characteristics, such as the printer and the format that is used

to produce the output. You can enter any valid SYSOUT parameters. This field is required if you leave the Option field blank.

If you enter either option 1 or option 2, the "SYSOUT class" field is ignored. However, for option 2, you can include the SYSOUT= operand in an OUTDD DD field.

Data Set Name

The name of the listing data set that you want ISPF to store your compare results in. This data set can be either partitioned or sequential.

The Data Set Name field is required if you use option 1 on this panel. This field serves the same purpose as the Listing DS Name field, which is used when running the SuperC utility in foreground mode.

The logical record length (LRECL) of the listing data set is displayed under the blank OUTDD lines on the SuperC Utility - Submit Batch Jobs panel. SuperC creates listings with one of four LRECLs:

- 132 Standard listing for the NOPRTCC process option; printer control characters are omitted.
- 133 Standard listing.
- 202 Wide listing for the NOPRTCC process option; printer control characters are omitted.
- 203 Wide listing.

If you specify an existing sequential data set with an incorrect LRECL, SuperC overrides the data set specifications. This applies to any listing and update data sets in both foreground and batch.

A separate operation, such as using the Hardcopy utility (option 3.6), is needed to print the listing data set.

If you leave the Option field blank or enter option 2, the Data Set Name field is ignored. Therefore, to specify an output data set in either of these two situations, you must include the DSN= operand in an OUTDD DD field.

When you are specifying the name of an existing data set, these rules apply:

- When you submit JCL for processing, the output listing produced by that JCL usually replaces the contents of the specified data set, if any exist. Therefore, be careful when specifying the name of an existing data set.

You can keep a history of changes by using the APNDLST compare option when you run the comparison. This compare option adds the new output listing to the contents of the specified sequential data set instead of replacing it.

Note: Using the APNDLST process option with a packed output listing file may cause unpredictable results in the output listing file.

- Use standard TSO data set naming conventions.

When you are specifying the name of a data set that does not exist, these rules apply:

- If you include a member name in the data set specification, ISPF allocates a partitioned data set with suitable attributes for the listing.

SuperC utility (option 3.12)

- If you do not specify a member name, ISPF allocates a sequential data set.

//OUTDD DD

Output data definitions that are used to specify additional printer instructions in job control language (JCL). This field is required if you use this panel. Otherwise, it is ignored.

The OUTDD DD fields are provided so you can pass to your printer all the JCL needed to format special types of output that may not be supported by your installation's SYSOUT class definitions. The example shown in Figure 128 on page 214 specifies a wide format for printing on 14 3/4-inch forms.

The "SYSOUT class" and Data Set Name fields are ignored. If you need to specify this information, be sure to include it in your OUTDD DD job card. If you specify a data set name in your OUTDD DD job card, the output data set is printed and kept. Otherwise, it is printed and deleted. Here are some examples:

- To specify a SYSOUT class, enter:

```
//OUTDD DD SYSOUT=X
```

where X is the SYSOUT class, such as A, B, or C.

- To specify a data set name, enter:

```
//OUTDD DD DSN=fully.qualified.name  
//          DISP=XXXXX...
```

where XXXXX... is one of these:

- For an old data set:

```
OLD
```

- For a new sequential data set:

```
(NEW,CATLG),SPACE=(3325,(50,100),RLSE),UNIT=SYSDA
```

- For a new partitioned data set

```
(NEW,CATLG),SPACE=(3325,(50,100,25),UNIT=SYSDA
```

- For a sequential data set that will be modified by, instead of replaced by, the comparison results:

```
MOD
```

Note: These three fields are independent of one another. Also, none of them requires you to provide an OUTDD card in the "Job statement information" field.

Using the NOLIST listing type in batch mode

If you enter the NOLIST listing type and choose batch mode, the options on the SuperC Utility - Submit Batch Jobs panel shown in Figure 128 on page 214 are not valid because no listing is produced. Therefore, an alternate panel is displayed, which blanks out the fields that are not valid but still allows you to submit job statement JCL. This panel is shown in Figure 129 on page 217.

```

Batch Submit - Nolist

Press ENTER to continue submit job or END to Cancel

Enter "/" to select option
/ Edit JCL before user submit

NOLIST listing type was specified. There will be no output generated.

Job statement information: (Required - Enter/Verify JOB control statement)

====> _____
====> _____
====> _____
====> _____

Command ====> _____
F1=Help      F2=Split    F3=Exit     F7=Backward F8=Forward  F9=Swap
F10=Actions  F12=Cancel

```

Figure 129. SuperC Utility - submit batch jobs panel using NOLIST (ISRSCSB1)

When this panel is displayed, you can either:

- Type the job statement JCL and press Enter to submit the job
- Enter the END command to cancel the job.

SuperCE utility (option 3.13)

The SuperCE utility (option 3.13) is a dialog that uses the SuperC program to compare data sets of unlimited size and record length at the file, line, word, or byte level. It is appropriate if you need more flexibility than the standard SuperC utility (option 3.12) provides.

Note: For an introduction to the SuperC and SuperCE utilities (options 3.12 and 3.13), see Appendix A, “SuperC reference,” on page 457.

The panel shown in Figure 130 on page 218 is the first panel of the SuperCE utility. It requires only the names of the input data sets, which are entered using standard TSO naming conventions, such as:

```
New DS Name . . . . 'USERID.TEST2.SCRIPT'
```

Note: In this context, a *new* data set is an updated version of a previously created data set, such as a data set in your private library that has not yet been promoted.

SuperCE utility (option 3.13)

```
Menu Utilities Options Help
-----
SuperCE Utility

New DS Name . . . _____
Old DS Name . . . _____
PDS Member List _____ (blank/pattern - member list, * - compare all)
(Leave New/Old DSN "blank" for concatenated-uncataloged-password panel)
Compare Type          Listing Type          Display Output
 2 1. File            2 1. OVSUM          1 1. Yes
  2. Line            2 2. Delta          2. No
  3. Word            3. CHNG            3. Cond
  4. Byte            4. Long            4. UPD
                    5. Nolist

Listing DSN . . . . SUPERC.LIST
Process Options . . _____

Statements Dsn . . . _____
Update DSN . . . . . _____

Enter "/" to select option      Execution Mode          Output Mode
_ Bypass selection list        1 1. Foreground        1 1. View
                               2 2. Batch             2 2. Browse

Command ==>
F1=Help   F2=Split   F3=Exit   F7=Backward F8=Forward F9=Swap
F10=Actions F12=Cancel
```

Figure 130. SuperCE Utility panel (ISRSEPRI)

SuperCE Utility panel action bar

The SuperCE Utility panel action bar choices function as follows:

Menu For more information, see the details about the Menu Action Bar Choice in the ISPF User Interface topic in the *z/OS ISPF User's Guide Vol I*.

Utilities

For more information, see the details about the Utilities Action Bar Choice in the ISPF User Interface topic in the *z/OS ISPF User's Guide Vol I*.

Options

The Options pull-down offers you these choices:

- 1 Edit Statements
- 2 Process Options
- 3 Profiles and Defaults

Help The Help pull-down provides general information about SuperCE topics, including how to specify the input data sets and options.

SuperCE Utility panel fields

A default compare type, listing type, listing data set name, and Browse option are provided if you choose not to specify your own. The fields on the SuperCE Utility panel are:

New DS Name and Old DS Name

Specify the name of a sequential data set, PDS, or membered PDS. Use standard TSO naming conventions, including quotes for fully qualified names. Leave either or both of these fields blank to display a panel on which you can specify concatenated, uncataloged, and password-protected

data sets. These panels are shown in Figure 131 on page 223 (foreground compare) and Figure 132 on page 224 (batch compare).

PDS Member List

Leave this field blank to display a member selection list for the new data set. Otherwise, enter either a pattern or an asterisk (*). See “SuperC member lists” on page 213 for more information.

pattern

Entering a pattern causes ISPF to display a list of the members in the new data set that match the pattern, unless Bypass Selection List has been specified. For more information about using patterns, see the “ISPF Libraries and Data Sets” chapter of the *z/OS ISPF User’s Guide Vol I*. For example:

```
PDS Member List . . ISR*
```

* Entering an asterisk causes all the members in the new data set to be compared to any like-named members in the old data set. A member list is not displayed. For example:

```
PDS Member List . . *
```

Members in either data set not having like-named members in the other data set are not compared, but are listed in the output list data set.

When entire data sets are compared by using an asterisk for a member name pattern, each real member that appears in both the old and new data sets is compared once. Alias entries are processed but only to determine if they have matching alias and/or real entries.

Note: You can also use SELECT process statements in the statements data set to specify an optional set of PDS members to be searched. However, the SELECT statement turns off the PDS member list function.

Compare Type

The type of comparison you want SuperC to perform. Choose one of these:

File Compares source data sets for differences, but does not show what the differences are. This is the simplest and fastest method with the least amount of processing overhead. For this compare type, SuperC prepares summary information only and causes all listing types to produce the same output, except NOLIST, which does not produce any output listing. A message is returned to notify you of the compare results.

Line Compares source data sets for line differences. Reformatted lines (that is, lines with blanks inserted or deleted) are automatically detected for lines less than or equal to 256 characters. This compare type is the default. It is most useful for comparisons of program source code because it is record-oriented and points out inserted or deleted lines of code. Lines can be of unlimited size.

Word Compares source data sets for word differences. In this context, a *word* is a group of characters that begins and ends with a blank or other line delimiter. If you use the XWDCMP process option, all non-alphanumeric characters are considered to be delimiters. Also, a word cannot be longer than 256 characters.

SuperCE utility (option 3.13)

The Word compare type is most useful for comparing text data sets. If two data sets contain the same words in the same order, SuperC considers them to be identical, even if those words are not on the same lines.

Byte Compares source data sets for byte differences. The output listing data set consists of a hexadecimal printout with character equivalents listed on the right. A BYTE compare with a LONG listing of a data set against itself results in a hexadecimal dump of that data set. This compare type is most useful for comparing machine readable data.

Listing Type

The type of listing you want SuperC to create when it compares the data sets. Listing Type is not a required field in SuperCE. If you do not specify a listing type, the default is DELTA. See the topic about Listing Formats in the *z/OS ISPF User's Guide Vol I* for sample listings.

OVSUM

Lists only the general summary of the comparison. However, a PDS comparison generates an individual summary line for each PDS member.

Delta Lists the differences between the source data sets, followed by the general summary.

CHNG

Lists the differences between the source data sets, plus up to 10 matching lines before and after the differences. This listing is a variation of the DELTA listing; the matching lines before and after help you recognize changed areas of the source data sets.

Long Lists all the new data set source lines, plus old data set deleted lines. Both inserted and deleted lines are flagged.

Nolist Produces no listing output. In foreground mode, a message is returned to show the outcome of the comparison.

Listing Dsn

The name of the list data set to which SuperC writes the results of the comparison. However, if you enter NOLIST in the Listing Type field, SuperC does not create an output listing, so this name is ignored.

If you leave this field blank, SuperC allocates a list data set, using default data set attributes and this data set name:

```
prefix.userid.SUPERC.LIST
```

where *prefix* is your TSO prefix and *userid* is your user ID. If your prefix and user ID are identical, only your prefix is used. Also, if you do not have a prefix, only your user ID is used.

Note: If the ISPF configuration table field USE_ADDITIONAL_QUAL_FOR_PDF_DATA_SETS is set to YES, an additional qualifier defined with the ISPF_TEMPORARY_DATA_SET_QUALIFIER keyword is included before the SUPERC qualifier.

If you enter a fully qualified data set name SuperC uses it as specified. Otherwise, SuperC only appends your TSO prefix to the front of the data

set name specified. If you run with TSO PROFILE NOPREFIX, SuperC uses the name as you entered it, which can result in an attempt to catalog the name in the master catalog.

If you enter the name of a data set that already exists, the contents of that data set are replaced by the new output listing. However, if the data set is sequential, you can add this listing to the data set instead of replacing it by using the APNDLST process option.

If you enter the name of a data set that does not exist, SuperC allocates it for you. The data set is allocated as a sequential data set unless you enter a member name after it, in which case it is allocated as a member of a partitioned data set.

Process Options

Keywords that tell SuperC how to process the compare operation. You can type these keywords in the Process Options fields or select them from a panel. See the Process Options selection in "Process options - select process options" on page 224 for a table of keywords.

Statements Dsn

The name of the data set that contains your process statements. All statements data sets must be fixed block with 80-byte records (FB 80). See the Edit Statements selection in "Process options - select process options" on page 224 for more information.

Update Dsn

Tells SuperC the name of the data set that will contain column-oriented results of the comparison. This data set is normally used as input to post processing programs and can be specified besides the normal listing data set.

If you leave this field blank and use an update (UPDxxx) option, SuperC uses this default name:

prefix.userid.SUPERC.UPDATE

where *prefix* is your TSO prefix and *userid* is your user ID. If your prefix and user ID are identical, only your prefix is used. Also, if you do not have a prefix, only your user ID is used.

Note: If the ISPF configuration table field USE_ADDITIONAL_QUAL_FOR_PDF_DATA_SETS is set to YES, an additional qualifier defined with the ISPF_TEMPORARY_DATA_SET_QUALIFIER field is included before the SUPERC qualifier.

If you enter a fully qualified data set name SuperC uses it as specified. Otherwise, SuperC only appends your TSO prefix to the front of the data set name specified. If you run with TSO PROFILE NOPREFIX, SuperC uses the name as you entered it, which can result in an attempt to catalog the name in the master catalog.

If you enter the name of a data set that already exists, the contents of that data set are replaced by the new update output. However, if the data set is sequential, you can add this listing to the data set instead of replacing it by using the APNDUPD process option.

If you enter the name of a data set that does not exist, SuperC allocates it for you. The data set is allocated as a sequential data set unless you enter a member name after it, in which case it is allocated as a partitioned data set.

SuperCE utility (option 3.13)

Note: For the UPDMVS8, UPDCMS8, UPDSEQ0, and UPDPDEL process options, the update data set contains valid data, but only after a successful compare when differences are detected. The data set is always empty after a comparison that shows the data sets or members being compared have no differences.

Display Output

Tells ISPF whether you want to display the output listing in Browse mode. Enter one of these:

Note: The NOLIST listing type overrides Yes, No, and Cond.

Yes Call Browse to display the listing data set after processing the comparison. This is the default.

No Do not call Browse to display the SuperC listing data set.

Cond Do not call Browse unless SuperC finds differences between the data sets.

UPD Browse the update data set instead of the list data set. This parameter is not valid unless you create an update data set by using one or more of the SuperC process options that begin with UPD (UPDxxx).

Bypass Selection List

When a member pattern is entered in the PDS Member List field, selecting this field causes SuperC to process all members matching that pattern without displaying a member selection list. Leaving this field blank causes the member list to be displayed.

Output Mode

The output mode for displaying the listing file. Choose one of these:

1 **View.** This enables the listing file to be displayed in *view* mode. All View functions are enabled in this mode.

2 **Browse.** This enables the listing file to be displayed in the *browse* mode. All Browse functions are enabled in this mode.

3 **Eview.** This option only appears on non-English panels. It operates exactly the same as View except that SuperC is invoked with an English language constants module. All titles and headings are in English. This facilitates use of highlighting of SuperC listings on non-DBCS terminals.

SuperCE utility options

These topics describe the Execution Mode options shown on the SuperCE Utility panel:

- "Foreground compare data sets"
- "Batch submit batch data set compare" on page 223
- "Process options - select process options" on page 224
- "Edit statements - edit statements data set" on page 225
- "Profiles and defaults - activate profiles and defaults" on page 226

Foreground compare data sets

If you choose **Foreground**, SuperC processes the data sets in foreground mode, so you can browse the results of the compare. This choice locks your keyboard until SuperC processing is complete.

The panel shown in Figure 131 is displayed if you leave the Option field and the New DS Name or Old DS Name field blank on the SuperCE Utility panel.

```

SuperCE - Concatenation Foreground Entry

                                "New" Concatenation
DS1 . . . _____
DS2 . . . _____
DS3 . . . _____
DS4 . . . _____

                                Other "New" Partitioned, Sequential or VSAM Data Set
Data Set Name . . . _____
Volume Serial . . . _____ (If not cataloged)
Password . . . . . _____ (Password allowed only in foreground mode)

                                "Old" Concatenation
DS1 . . . _____
DS2 . . . _____
DS3 . . . _____
DS4 . . . _____

                                Other "Old" Partitioned, Sequential or VSAM Data Set
Data Set Name . . . _____
Volume Serial . . . _____ (If not cataloged)
Password . . . . . _____ (Password allowed only in foreground mode)
Command ==>>
F1=Help      F2=Split    F3=Exit      F7=Backward  F8=Forward  F9=Swap
F12=Cancel

```

Figure 131. SuperCE - concatenation interactive entry panel (ISRSECAT)

For fields DS1 through DS4, both new and old, use normal TSO naming conventions. You can specify a series of concatenated data sets, an uncataloged or password-protected data set, or a cataloged data set.

Up to four data sets can be concatenated for both the new and old input data sets. Make sure the data sets are concatenated in the proper sequence, as follows:

1. If two or more sequential data sets are concatenated as one input data set, the data set attributes, such as block size, must be identical.
2. PDS concatenations must have the data set with the largest block size as the first in any concatenation.
3. The SuperCE dialog uses only the first occurrence of a member in the concatenated series of PDSs as source input for a compare. Any other occurrences of the member are ignored.

Other partitioned or sequential data sets, volume serials, and data set passwords are specified as on any other data entry panel. See the "ISPF Libraries and Data Sets" chapter of the *z/OS ISPF User's Guide Vol 1* for more information.

Note: The Password fields apply only to the other partitioned or sequential data sets. TSO prompts you if any concatenated data sets are password-protected. The Password field is only enabled in foreground mode.

Batch submit batch data set compare

Option B causes SuperC to process the data sets in batch mode. This choice frees the keyboard, allowing you to continue using ISPF while waiting for SuperC to

SuperCE utility (option 3.13)

compare the data sets. The output listing is sent to the destination specified on the SuperC Utility - Submit Batch Jobs panel (Figure 128 on page 214).

The panel shown in Figure 132 is displayed if you select option B and leave the New DS Name or Old DS Name field blank on the SuperCE Utility panel. You can concatenate up to four data sets that have like attributes. For example, all must be either sequential or partitioned.

```

SuperCE - Concatenation Batch Entry

                                "New" Concatenation
DS1 . . . _____
DS2 . . . _____
DS3 . . . _____
DS4 . . . _____

                                Other "New" Partitioned, Sequential or VSAM Data Set
Data Set Name . . . _____
Volume Serial . . . _____ (If not cataloged)
Password . . . . . _____ (Password allowed only in foreground mode)

                                "Old" Concatenation
DS1 . . . _____
DS2 . . . _____
DS3 . . . _____
DS4 . . . _____

                                Other "Old" Partitioned, Sequential or VSAM Data Set
Data Set Name . . . _____
Volume Serial . . . _____ (If not cataloged)
Password . . . . . _____ (Password allowed only in foreground mode)
Command ==>>>
F1=Help      F2=Split    F3=Exit      F7=Backward  F8=Forward  F9=Swap
F12=Cancel

```

Figure 132. SuperCE - Concatenation Batch Entry panel (ISRSECAT)

This panel is the same as the panel shown in Figure 131 on page 223, except the Password field is omitted. If your data sets are password protected, compare the data sets in foreground mode by leaving the Option field on the SuperCE Utility panel blank.

Printing a SuperCE listing in batch mode: If you selected option B on the SuperCE Utility panel, the panel shown in Figure 128 on page 214 is displayed before the job is submitted. This panel allows you to determine whether to print your SuperC listing or write it to a list data set.

Process options - select process options

The compare type that you select determines the available process options:

Line Compare

```

|          ASCII  ALLMEMS ANYC  APNDLST APNDUPD CKPACKL CNPML  COBOL  COVSUM
|          Cpnnnnn DLMDUP  DLREFM DPACMT  DPADCMT DPBLKCL DPCBCMT DPCPCMT DPFTCMT
|          DPMACMT DPPLCMT DPPSCMT FMVLNS  GWCBL  LOCS  LONGLN  MIXED  NARROW
|          NOPRTCC NOSEQ  NOSUMS REFMOVR SEQ  UPDCMS8 UPDCNTL UPDLDEL UPDMVS8
|          UPDPDEL UPDREV  UPDREV2 UPDSEQ0 UPDSUMO VTITLE  WIDE  Y2DTONLY

```

Word Compare

```

|          ASCII  ALLMEMS ANYC  APNDLST APNDUPD CKPACKL COBOL  COVSUM
|          Cpnnnnn DPACMT  DPADCMT DPBLKCL DPCBCMT DPCPCMT DPFTCMT DPMACMT
|          DPPLCMT DPPSCMT GWCBL  LOCS  MIXED  NOPRTCC NOSEQ  NOSUMS
|          SEQ  UPDCNTL UPDREV  UPDREV2 UPDSUMO VTITLE  XWDCMP

```

Byte Compare

```

ASCII  ALLMEMS APNDLST APNDUPD COVSUM  Cpnnnnn
LOCS   NOPRTCC NOSUMS  UPDCNTL UPDSUMO VTITLE

```

File Compare

```

ASCII  ALLMEMS APNDLST COVSUM  Cpnnnnn
FMSTOP LMCSFC  LOCS    NOPRTCC

```

To select one or more SuperCE process options, perform either of these actions:

- Type any nonblank character to the left of the process options you want to select. If move + or move -+ is shown, use the Backward and Forward keys to move through the panel. Press Enter when you have finished. This causes the options you chose to be displayed in the Process Options fields on the SuperCE Utility panel. If you select two options that cannot be chosen together, or if you enter an option name incorrectly, an error message is displayed.
- Use the CANCEL command to return to the SuperCE Utility panel without processing selections.

SuperC process options can affect how the input data is processed, and determine the format and content of the output listing data set. They can also help you save processing time by avoiding comments and blank lines. A separate group of options, called update data set options (UPDxxx), allow you to create update data sets, examples of which are shown in Appendix C, “Update files,” on page 527.

All these options can be chosen from the XXXX Compare Process Options panels, where XXXX is the compare type (FILE, LINE, WORD, or BYTE) that you are using. The only exception is that the DPxxx (do not process) options are not available from a selection panel when you are conducting a WORD comparison. However, you can type any of them in the Process Options field on the SuperCE Utility panel. Errors caused by mistyping process options are detected when you call the SuperCE utility.

For definitions of the SuperC process options, see “Process options” on page 461.

Edit statements - edit statements data set

A statements data set consists of process statements that contain instructions for the SuperC program. They are similar to the process options, but are composed of a keyword and one or more operands. See “Process options - select process options” on page 224 for information about SuperCE process options.

When you select the Edit Statements option from the SuperCE Utility Options pull-down menu, the SuperCE utility displays the statements data set you specified in the Statements Dsn field. This data set is always displayed in Edit mode, allowing you to add, change, or delete SuperC process statements as needed. Only one process statement can appear on each line of the statements data set.

The size of the Edit window depends on the number of lines your terminal can display. The sample panel shown in Figure 133 on page 226 shows how the Edit window appears on a 24-line display. Examples of some common process statements are listed below the Edit window so you can easily compose the proper input line.

SuperCE utility (option 3.13)

```
USERID.SUPERC.STMTS                               Columns 00001 00072

Enter or change Process Statements in the EDIT window below:
***** ***** Top of Data *****
.....
.....
.....
.....
.....
***** ***** Bottom of Data *****

Examples      Explanation
CMPCOLM 5:60 75:90    Compare using two column compare ranges
LSTCOLM 25:90        List columns 25:90 from input
DPLINE 'PAGE '       Exclude line if "PAGE " found anywhere on line
SELECT MEM1,NMEM2:OMEM2  Compare MEM1 with MEM1 and NMEM2 with OMEM2
CMPLINE NTOP 'MACRO' Start comparing after string found in new DSN
LNCT 66              Set lines per page to 66
-----

Others: CHNGV  CMPBOFS  CMPCOLMN  CMPCOLMO  CMPSECT  DPLINEC  NCHGT
Command ==>>>                               Scroll ==>> PAGE
F1=Help      F2=Split      F3=Exit      F5=Rfind      F6=Rchange   F7=Up
F8=Down      F9=Swap       F10=Left     F11=Right     F12=Cancel
```

Figure 133. SuperC process statements panel (ISRSEPRS)

The SuperC program validates process statements at run time. Invalid process statements are not used and are noted at the bottom of the listing. Unless a higher return code is required by some other condition, a return code of 4 is generated.

See “Process statements” on page 472 for process statement syntax, definitions, and examples.

Profiles and defaults - activate profiles and defaults

A SuperC profile is a data set that can contain a compare type, a listing type, a Browse setting, and various combinations of process options and process statements that you select.

SuperC profiles are useful for a wide range of users. Beginners can use profiles created by others as a simple method of running SuperC. Experienced SuperC users can create profiles for the groups of options they use often so that they do not have to remember individual process options and statements. Also, profiles give system programmers a mechanism for setting up complex compare tools that others can simply call by profile name.

Some other characteristics of profiles are:

- A profile can be either a sequential data set or a member of a PDS.
- Data set names are not represented in a profile.
- Profiles can be created only with the SuperCE utility (option 3.13). However, once they are created, they can be used in the standard SuperC utility (option 3.12).
- To change a profile, activate it and make the necessary changes to the information in the fields on the SuperCE Utility panel. Then select option C and create a profile, entering in the Activate/Create Profile DS Name field the name of the profile data set that you want to modify.

- You can modify the SuperC default settings by selecting the Defaults option on the Profile Manager screen. See Figure 136 on page 230 for an example of the SuperC - Defaults panel.
- You can display the contents of a profile data set using View, Browse, or Edit. Figure 134 shows a Browse display of a profile data set.

```
Menu Utilities Compilers Help
-----
USERID.TESTPROF                               Line 00000000 Col 001 080
***** Top of Data *****
.* PROF PREFIX CTYP=LINE,LTYP=DELTA ,BRW=YES
.* PROF PREFIX PROC1=                          * MARGIN*
.* PROF PREFIX PROC2=                          * MARGIN*
***** Bottom of Data *****

Command ==>                                     Scroll ==> PAGE
F1=Help   F2=Split  F3=Exit  F5=Rfind  F7=Up    F8=Down  F9=Swap
F10=Left  F11=Right F12=Cancel
```

Figure 134. Browse a SuperCE profile

Selecting option A on the SuperCE Utility panel displays this panel. The panel is used to activate and create profiles.

SuperCE utility (option 3.13)

```

                                SUPERCE - Profile Manager

A Activate   Reads the specified input profile data set:
              1. Establishes the process and compare options from the
                profile prefix lines.
              2. Establishes the profile as the process statement data set
                if any process statements are detected.

C Create     Creates an output profile data set:
              1. Combines process and compare options from the Primary Panel
                and any process statements from the Statements Data Set:
              2. Rewrites the profile data set (if the data set exists) or
                allocates a new data set before generating the profile.

D Defaults   Presents panel for modifying SuperC defaults.

Activate/Create
Profile DS Name . . . _____

Option ==> _____
F1=Help   F2=Split  F3=Exit  F9=Swap  F12=Cancel
```

Figure 135. SuperCE - Profile Manager panel (ISRSEPMG)

The only field on this panel is:

Activate/Create Profile DS Name

The name of the profile data set that you want to either activate or create. This field is required.

If you choose option A (Activate), SuperCE copies the compare type, listing type, Browse setting, and any process options this data set contains. If the profile also contains process statements, SuperCE displays the name of the profile data set in the Statements Dsn field on the SuperCE Utility panel.

If you choose option C (Create), SuperCE copies the information that is saved into one output data set or member.

These topics describe the options shown at the top of the SuperCE - Profile Manager panel:

- “A — activate”
- “C — create”
- “D — defaults” on page 229

A — activate: Option A (Activate) restores the contents of the profile data set specified in the Activate/Create Profile DS Name field. This data set must be cataloged. When you press Enter, information that was stored in the profile data set when it was created is displayed in the corresponding fields on the SuperCE Utility panel. For example, process options stored in the profile appear in the Process Options fields. At this point, you can make additional changes or choose another option.

C — create: Option C (Create) causes SuperCE to copy data entered on the SuperCE Utility panel and place it in the profile data set specified in the Activate/Create Profile DS Name field. Be sure the correct information is displayed on that panel and that the statements data set, if you specify one, contains the correct process statements before you create the profile.

If the profile data set that you specify does not already exist, SuperCE allocates it for you. Data stored in the profile data set can include:

- These values taken from the fields on the SuperCE Utility panel. The abbreviations in parentheses show how these values are identified in a profile data set:
 - Compare type (CTYP)
 - Listing type (LTYP)
 - Browse setting (BRW)
 - Process options (PROC1 and PROC2).
- Process statements copied from the statements data set that was specified in the Statements Dsn field. This data set name is displayed and highlighted on the SuperCE - Profile Manager panel. For example, the sample panel shown in Figure 135 on page 228 displays the name SUPERC.STMTS.

If you leave the Statements Dsn field blank, the data set name and the words preceding it are not displayed on the SuperCE - Profile Manager panel and SuperCE does not include any process statements in your profile. See these topics about process options and process statements, respectively:

- “Process options - select process options” on page 224
- “Edit statements - edit statements data set” on page 225

D — defaults: Option D (Defaults) brings up an additional panel, shown in Figure 136 on page 230, that allows you to:

- Specify SuperC output data set default allocation parameters

The first extent and secondary space values are used whenever Options 3.12, 3.13, or 3.14 create a new output data set such as a listing or statements data set. If you specify a new data set with a member name, the directory space value is used to create a PDS. If you blank out any of the values, SuperC will supply defaults.

Space values are applicable only if you select “Invoke SuperC via PROGRAM interface”.

Note: New data set allocation block size parameters are controlled by the PDF Configuration Table. See *z/OS ISPF Planning and Customizing* for details.

- Specify your own Statements data set initial edit macro name
- Enable or disable a new high performance program interface to SuperC. If you select “Invoke SuperC via PROGRAM interface”, ISPF invokes SuperC directly. Otherwise, ISPF invokes SuperC via a CLIST named ISRSFORG (ISRSSRCH for Search-For). The CLIST interface may be useful if you need to customize the allocations or wish to post-process the result. The PROGRAM interface is more efficient and is the default.

Search-For utility (option 3.14)

```

                                SUPERC - Defaults

                                Verify entries below. End or Enter to exit.

New List data set allocation in blocks:
1st Extent . . 50   Secondary . . 100   Directory . . 5

New Update data set allocation in blocks:
1st Extent . . 15   Secondary . . 30   Directory . . 5

New Profile data set allocation in blocks:
1st Extent . . 5    Secondary . . 5    Directory . . 5

New Statements data set allocation in blocks:
1st Extent . . 5    Secondary . . 5    Directory . . 5

Statements data set initial edit macro name . . !ISRSMAC

Enter "/" to select option
/  Invoke SuperC via PROGRAM interface

Command ==>>> _____
F1=Help   F2=Split  F3=Exit   F9=Swap  F12=Cancel
```

Figure 136. SuperC - Defaults panel (ISRSDFLT)

Search-For utility (option 3.14)

Note: For an introduction to the Search-For and Extended Search-For utilities (options 3.14 and 3.15), see Appendix A, “SuperC reference,” on page 457.

The Search-For utility (option 3.14) is a dialog that uses the SuperC program to search your data sets or PDS members for one or more character strings. The Search-For Utility panel, shown in Figure 137 on page 231, is the first panel of the Search-For utility. The only requirements for this panel are:

- A string to be searched for, unless you select “Specify additional search strings”
- A data set to search, along with a volume serial and password if necessary.

A default listing data set name is provided if you choose not to enter your own.

```

Menu  RefList  Utilities  Help
-----
Search-For Utility
More:  +
Search String . . . _____

ISPF Library:
Project . . . _____
Group . . . . _____ . . . . _____ . . . . _____
Type . . . . _____
Member . . . _____ (Blank or pattern for member selection list,
                        "*" for all members)
Other Partitioned, Sequential or VSAM Data Set:
Data Set Name . . . _____
Volume Serial . . . _____ (If not cataloged)

Listing Data Set . . . SRCHFOR.LIST
Data Set Password . . . _____ (If Search-For data set password protected)

Enter "/" to select option      Execution Mode      Output Mode
- Specify additional search strings  1 1. Foreground    1 1. View
- Mixed Mode                       2 2. Batch         2 2. Browse
- Bypass selection list

Command ==>
F1=Help    F2=Split    F3=Exit    F7=Backward  F8=Forward  F9=Swap
F10=Actions  F12=Cancel

```

Figure 137. Search-For Utility panel (ISRSFSPR)

Search-For Utility panel action bar

The Search-For Utility panel action bar choices function as follows:

Menu For more information, see the details about the Menu Action Bar Choice in the ISPF User Interface topic in the *z/OS ISPF User's Guide Vol I*.

RefList

For information about referral lists, see the topic about Using Personal Data Set Lists and Library Lists in the *z/OS ISPF User's Guide Vol I*.

Utilities

For more information, see the details about the Utilities Action Bar Choice in the ISPF User Interface topic in the *z/OS ISPF User's Guide Vol I*.

Help The Help pull-down provides general information about Search-For topics, including how to specify the input data sets, search string, and options.

Search-For Utility panel fields

All the fields on this panel are explained in the Libraries and Data Sets topic in the *z/OS ISPF User's Guide Vol I*, except these:

Search String

A string to be searched for. No distinction is made between uppercase and lowercase characters. Use the Extended Search-For utility (option 3.15) to specify case-sensitive searches.

Four keywords—C, PREFIX, SUFFIX, and WORD—can help you narrow the scope of a search. See “Search-For strings and keywords” on page 233 for information about these keywords and the rules that govern search string entry.

Search-For utility (option 3.14)

Specify additional search strings

Select this field to have the Search-For utility search for more than one string. The Search-For utility displays the panel shown in Figure 138 on page 233, on which you can specify additional search strings. This panel precedes a member list request.

If you do not select this option, the Search-For utility searches only for the string entered in the Search String field.

Mixed Mode

Select this field to have the Search-For utility scan and parse the input data set lines for DBCS text strings.

Note: The Word, Prefix, and Suffix Search-For qualifiers have no effect on DBCS strings.

Bypass Selection List

When a member pattern is entered in the PDS Member List field or the member name portion of the data set field (such as MY.DATA.SET(*pattern*)), selecting this field causes SuperC to process all members matching that pattern without displaying a member selection list. Leaving this field blank causes the member list to be displayed.

Execution Mode

The processing mode you want to use when searching the data sets. Specify one of these:

- 1 **Foreground.** Searches the data sets and stores the results in the data set specified in the Listing Data Set Name field. You can browse the listing data set at the terminal.
- 2 **Batch.** Causes the display of the Search-For Utility - Submit Batch Jobs panel so that you can specify job card and print disposition information or edit the JCL statements. Then, Search-For submits the batch job to search the data sets. See "Submitting a Search-For job in batch mode" on page 236 for more information.

Note: You cannot specify a data set password in batch mode. If your data sets are password protected, use foreground mode.

Output Mode

The output mode you want to use when displaying the listing file. Choose one of these:

- 1 **View.** This enables the listing file to be displayed in *view* mode. All View functions are enabled in this mode.
- 2 **Browse.** This enables the listing file to be displayed in the *browse* mode. All Browse functions are enabled in this mode.

Listing Data Set

The name of the listing data set to which the SuperC program writes the results of the search. If you leave this field blank, the Search-For utility allocates a listing data set, using default data set attributes and this data set name:

prefix.userid.SRCHFOR.LIST

where *prefix* is your TSO prefix and *userid* is your user ID. If your prefix and user ID are identical, only your prefix is used. Also, if you do not have a prefix, only your user ID is used.

Note: If the ISPF configuration table field USE_ADDITIONAL_QUAL_FOR_PDF_DATA_SETS is set to YES, an additional qualifier defined with the ISPF_TEMPORARY_DATA_SET_QUALIFIER field is included before the SRCHFOR qualifier.

If you enter a fully qualified data set name SuperC uses it as specified. Otherwise, SuperC only appends your TSO prefix to the front of the data set name specified. If you run with TSO PROFILE NOPREFIX, SuperC uses the name as you entered it, which can result in an attempt to catalog the name in the master catalog.

If you enter the name of a data set that does not exist, the Search-For utility allocates it for you. The data set is allocated as a sequential data set unless you enter a member name after it, in which case it is allocated as a partitioned data set.

Specifying additional search strings

The panel shown in Figure 138 is displayed if you select “Specify additional search strings” on the Search-For Utility panel. You can specify:

- Additional strings to be searched for
- Optional scan-type and continuation keywords.

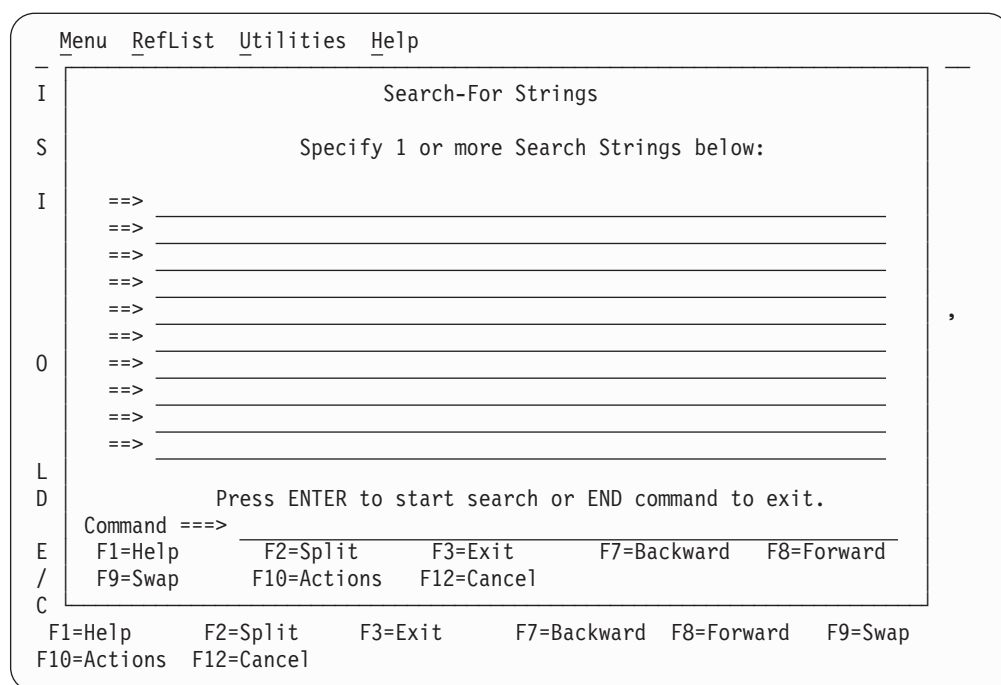

Figure 138. Additional Search Strings panel (ISRSFSST)

From this panel, pressing Enter either:

- Displays a member list, if requested
- Runs the search if no member list is needed.

Entering the END command returns you to the Search-For Utility panel.

Search-For strings and keywords

Enter the strings that you want SuperC to find. When you press Enter, SuperC looks for the strings without regard to whether they appear in uppercase or

Search-For utility (option 3.14)

lowercase in the original data set. If you are searching a partitioned data set concatenation, SuperC will inform you (in the CONCAT# field in the listing) in which group it first found the string. If you want SuperC to search all the groups for each member, you can use the SDUPM process option of Extended Search-For (option 3.15). If you want the search to distinguish between uppercase and lowercase, you must use Extended Search-For (option 3.15). If any of the strings are found (string-1 OR string-2 OR string-3) on the line, SuperC considers the condition met. You can restrict SuperC searches further by using one of the SuperC Search-for keywords discussed in "Using keywords."

Entering search strings

Enclose the string in single quotation marks if it contains embedded blanks or apostrophes. Two consecutive apostrophes must be entered to specify a single apostrophe within a search string.

If you need to specify a DBCS string that contains a hexadecimal '7D' (x'7D', the hexadecimal representation of a single quotation mark) as half of a DBCS pair, you must use the Enhanced SearchFor option (option 3.15) with the MIXED process option.

This example searches for the string IT'S A LIVING.

```
==> 'IT'S A LIVING'
```

Using keywords

These keywords can help you narrow the range of the search. If you do not use a keyword, SuperC will find the string wherever it exists, even if that happens to be in the middle of a word.

PREFIX

Shows the string is preceded by a non-alphanumeric character, such as a blank space. It cannot be used on the same line with SUFFIX or WORD. For example, you can do this:

```
==> ELSE PREFIX  
==> ELSE SUFFIX
```

but not this:

```
==> ELSE PREFIX SUFFIX
```

SUFFIX

Shows the string is followed by a non-alphanumeric character. It cannot be used on the same line with PREFIX or WORD. See the examples under PREFIX.

WORD

Shows the string is both preceded and followed by a non-alphanumeric character. It cannot be used on the same line as PREFIX or SUFFIX. See the examples under PREFIX.

C Continuation. Shows continuation of the previous line(s). Continuation lines generate additional strings, all of which must be found in the same line of an input data set.

Also, the C keyword can be entered on the same line as one of the other keywords. This example tells SuperC to find ELSE and to also find IF, but only when IF is on the same line as ELSE.

```
==> ELSE WORD  
==> IF WORD C
```

Search-For member lists

A panel similar to the one shown in Figure 139 is displayed only if:

- The search data set is partitioned.
- The Member field on the Search-For Utility panel (Figure 137 on page 231) or the PDS Member List field on the Extended Search-For Utility panel (Figure 141 on page 237) was left blank or a pattern was used and Bypass Selection List was not selected. For more information on Displaying Member Lists, see the “ISPF Libraries and Data Sets” chapter of the *z/OS ISPF User’s Guide Vol I*.
- For the Extended Search-For utility (option 3.15), the statements data set being used does not contain any SELECT process statements.

<u>M</u> enu	<u>F</u> unctions	<u>U</u> tilities	<u>H</u> elp		
SEARCH	USERID.DATASET				Row 00001 of 00026
Enter END command to process selections or CANCEL to leave the member list.					
Name	Prompt	Size	Created	Changed	ID
. COPY01T		10	2002/09/06	2002/09/17 12:56:47	USERID
. COPY01TM		10	2002/08/26	2002/08/28 18:23:19	USERID
. COPY0102		17	2002/09/05	2002/09/06 09:59:12	USERID
. DCAR		7	2002/08/06	2002/08/06 13:59:01	USERID
. DT1		5	2002/08/08	2002/08/08 17:09:42	USERID
. FMNCCPY1		17	2002/09/12	2002/09/18 14:45:55	USERID
. FMNCCPY2		17	2002/09/12	2002/09/12 15:10:06	USERID
. NEWCCPYT		17	2002/09/05	2002/09/05 18:24:29	USERID
. TEMP0102		17	2002/08/28	2002/08/28 18:38:02	USERID
. TESTMD1		10	2002/08/29	2002/08/29 17:02:17	USERID
. TEST0102		17	2001/03/08	2002/09/02 15:18:53	USERID
. TEST3		17	2002/09/06	2002/09/06 10:04:59	USERID
. TEST4		17	2002/09/06	2002/09/06 11:26:50	USERID
Command ==>			Scroll ==> PAGE		
F1=Help	F2=Split	F3=Exit	F5=Rfind	F7=Up	F8=Down
F10=Left	F11=Right	F12=Cancel			

Figure 139. Search member list panel (ISRSSML)

To start the search, enter the END command.

To cancel your selections, enter either:

- The RESET command to remove all unprocessed selections without ending the member list display
- The CANCEL command to end the member list display without processing selections still on the screen.

Note: Both the jump function (=) and the RETURN command cause an implied cancellation of selections before they are carried out.

For more information about member lists, see the Using Member Selection Lists section of the “ISPF Libraries and Data Sets” chapter of the *z/OS ISPF User’s Guide Vol I*.

Search-For utility (option 3.14)

Submitting a Search-For job in batch mode

If you selected Batch Mode (2) on the Search-For Utility panel, the panel shown in Figure 140 is displayed before the job is submitted.

```
Search-For Utility - Submit Batch jobs

Press ENTER to continue submit

Enter "/" to select option          Generate Output Type:
/_ Edit JCL before user submit      1 1. SYSOUT Class
                                     2 2. Data Set Name
                                     3 3. //OUTDD DD

SYSOUT Class . . . . A _____
Data Set Name . . . . _____
//OUTDD DD . . . . _____
// . . . . . . . . . . _____
                                LRECL for the Listing Output will be 133

Job statement information: (Required - Enter/Verify JOB control statement)
====> _____
====> _____
====> _____
====> _____
Command ====>
F1=Help   F2=Split   F3=Exit   F7=Backward F8=Forward F9=Swap
F12=Cancel
```

Figure 140. Search-For Utility - Submit Batch Jobs panel (ISRSFSSUB)

This panel allows you to specify one of these Generate Output types:

- The SYSOUT class, which determines the printer to which your job is sent and the format used for the printed output
- The name of a listing data set
- Output data definitions that you can use to give the printer additional instructions, such as an output destination that is not defined by a SYSOUT class.

The Job Statement information field is explained in the details about Job Statement Information in the Libraries and Data Sets topic of the *z/OS ISPF User's Guide Vol I*. The other fields on this panel, as well as the options listed at the top of the panel, are described in "Submitting a SuperC job in batch mode" on page 214.

Search-ForE utility (option 3.15)

Note: For an introduction to the Search-For and Extended Search-For utilities, see Appendix A, "SuperC reference," on page 457.

If you select option 3.15, the Extended Search-For Utility panel, shown in Figure 141 on page 237, is displayed. This utility is a dialog that uses the SuperC program to search your data sets or PDS members for one or more character strings. It is appropriate if you need more flexibility than the standard Search-For utility (option 3.14) provides.

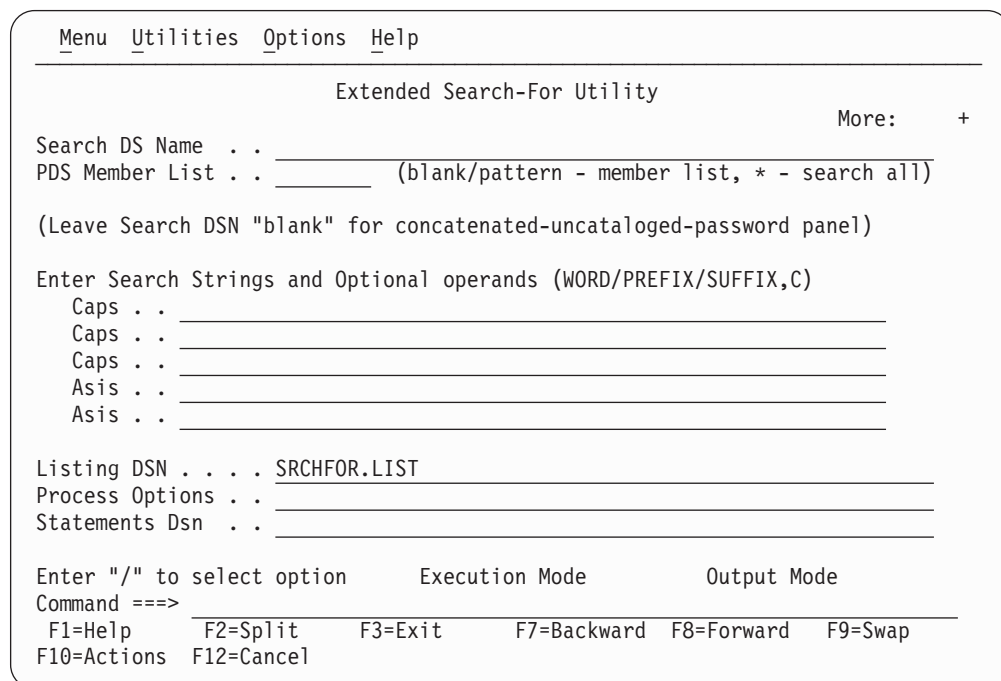

Figure 141. Extended Search-For Utility panel (ISRSFPRI)

Search-ForE Utility panel action bar

The Search-ForE Utility panel action bar choices function as follows:

Menu For more information, see the details about the Menu Action Bar Choice in the ISPF User Interface topic in the *z/OS ISPF User's Guide Vol I*.

Utilities

For more information, see the details about the Utilities Action Bar Choice in the ISPF User Interface topic in the *z/OS ISPF User's Guide Vol I*.

Options

- 1 Edit statements
- 2 Process options

Help The Help pull-down provides general information about Extended Search-For topics, including how to specify data sets, search strings, process options and process statements.

Search-ForE Utility panel fields

The panel requires only the entry of character string(s). The fields on this panel are:

Search DS Name

Specify the name of a sequential data set, PDS, or membered PDS. Use standard TSO naming conventions, including quotes for fully qualified names. Leave this field blank to display a panel on which you can specify concatenated, uncataloged, and password-protected data sets. This panel is shown in Figure 142 on page 240.

PDS Member List

Leave this field blank to display a list of all the members in the search data

Search-ForE utility (option 3.15)

set. Otherwise, enter a pattern or an asterisk (*). See "Search-For member lists" on page 235 for more information.

pattern

Entering a pattern causes ISPF to display a list of the members in the search data set that match the pattern unless Bypass Selection List was selected. See the topic about Displaying Member Lists in the "ISPF Libraries and Data Sets" chapter of the *z/OS ISPF User's Guide Vol I* for more information about using patterns. For example:

```
PDS Member List . . . ISR*
```

- * Entering an asterisk causes all the members in the search data set to be searched.

You can also use SELECT process statements in the statements data set to specify an optional set of PDS members to be searched. However, the SELECT statement turns off the PDS member list function.

CAPS A search string that you want the Extended Search-For utility to find. This search string is converted to uppercase before the search begins and is found only if it exists in the search data set in uppercase.

The ANYC process option causes the string to be found in any case, (uppercase, lowercase, or mixed case) even if you enter the string in the CAPS field.

You can enter up to three uppercase search strings, one in each CAPS field. Here are some examples:

example 1

Either of these strings may be found in the search data set:

```
CAPS . . . . THEN  
CAPS . . . . IF
```

example 2

The two strings shown must be found on the same line because of the continuation (C) keyword. THEN must be a complete word, while ISR must be the prefix of a word.

```
CAPS . . . . THEN WORD  
CAPS . . . . ISR PREFIX C
```

example 3

In the next example, a hexadecimal string is specified as the search string. Use this to find unprintable characters.

```
CAPS . . . . X'7B00'
```

example 4

This example searches for the string JOE'S CLIST. Notice that the string is enclosed in single quotation marks and the apostrophe following Joe's name has been doubled.

```
CAPS . . . . 'JOE'S CLIST'
```

ASIS A search string that you want the Extended Search-For utility to find. This search string is searched for as it is when you enter it in the ASIS field. Therefore, the Extended Search-For utility does not find the string unless it exists in the data set exactly as you enter it in an ASIS field. You can enter one search string in each ASIS field.

The examples following the CAPS field definition apply to the ASIS field as well.

See “Search-For strings and keywords” on page 233 for a list of rules that determine the format required for entering search strings and for definitions of the keywords that are shown in the examples.

The SRCHFOR and SRCHFORC process statements override any strings entered in the CAPS and ASIS fields.

Listing DS Name

The name of the list data set to which the Extended Search-For utility writes the listing information. If you leave this field blank, Extended Search-For allocates a list data set, using default data set attributes and this data set name:

```
prefix.userid.SRCHFOR.LIST
```

where *prefix* is your TSO prefix and *userid* is your user ID. If your prefix and user ID are identical, only your prefix is used. Also, if you do not have a prefix, only your user ID is used.

Note: If the ISPF configuration table field USE_ADDITIONAL_QUAL_FOR_PDF_DATA_SETS is set to YES, an additional qualifier defined with the ISPF_TEMPORARY_DATA_SET_QUALIFIER field is included before the SRCHFOR qualifier.

If you enter a fully qualified data set name SuperC uses it as specified. Otherwise, SuperC only appends your TSO prefix to the front of the data set name specified. If you run with TSO PROFILE NOPREFIX, SuperC uses the name as you entered it, which can result in an attempt to catalog the name in the master catalog.

If you enter the name of a data set that already exists, the contents of that data set are replaced by the new listing output. However, if the data set is sequential, you can add this listing to the data set instead of replacing it by using the APNDLST process option.

If you enter the name of a data set that does not exist, Search-For allocates it for you. The data set is allocated as a sequential data set unless you enter a member name after it, in which case it is allocated as a partitioned data set.

Process Options

Keywords that tell SuperC how to process the search-for operation. You can type these keywords in the Process Options field or select them from a panel. See “Process options” on page 461 for tables of keywords.

Bypass Selection List

When a member pattern is entered in the PDS Member List field, selecting this field causes SuperC to process all members matching that pattern without displaying a member selection list. Leaving this field blank causes the member list to be displayed.

Statements Dsn

The name of the data set that contains your search-for process statements, which you can create or change by using option E on the Extended Search-For Utility panel. SuperC reads these process statements before conducting the search. All statements data sets must be fixed block with 80-byte records (FB 80).

Execution Mode

Search-ForE utility (option 3.15)

Foreground

If you choose option 1, Foreground, and you leave the Search DS Name field blank, the Extended Search-For - Concatenation Data Set Entry panel, shown in Figure 142, is displayed.

```
Extended Search-For Concatenation Foreground Entry

                                "Search" Concatenation
DS1 . . . . _____
DS2 . . . . _____
DS3 . . . . _____
DS4 . . . . _____

                                Other "Search" Partitioned, Sequential or VSAM Data Set
Data Set Name . . . . _____
Volume Serial . . . . _____ (If not cataloged)
Password . . . . . _____ (Password allowed only in foreground mode)

Command ==> _____
F1=Help      F2=Split    F3=Exit      F7=Backward  F8=Forward   F9=Swap
F12=Cancel
```

Figure 142. Extended Search-For - concatenation data set entry panel (ISRSFCON)

For fields DS1 through DS4, use normal TSO naming conventions. You can specify a series of concatenated data sets, an uncataloged or password-protected data set, or a cataloged data set name.

Up to four data sets can be concatenated. Make sure the data sets are concatenated in the proper sequence, as follows:

1. If two or more sequential data sets are concatenated as one input data set, the data set attributes, such as block size, must be identical.
2. PDS concatenations must have the data set with the largest block size as the first in any concatenation.
3. Search-For uses only the first occurrence of a member in the concatenated series of PDSs as source input for a search. Any other occurrences of the member are ignored. You may specify the SDUPM process option to cause SuperC to search for and report all occurrences of the string for the entire concatenated series of PDS members.

Other partitioned or sequential data sets, volume serials, and data set passwords are specified as on any other data entry panel. For more information, see the "ISPF Libraries and Data Sets" chapter in the *z/OS ISPF User's Guide Vol I*.

Note: The Password field applies only to the other partitioned or sequential data set. TSO prompts you if any concatenated data sets are password-protected.

Batch Option 2 causes SuperC to process the data sets in batch mode.

Search-ForE utility (option 3.15)

This choice frees the keyboard, allowing you to continue using ISPF while waiting for SuperC to search the data sets. The output listing is sent to the destination specified on the Search-For Utility - Submit Batch jobs panel (Figure 140 on page 236).

This panel is displayed if you select option 2 and leave the Search DS Name field blank on the Extended Search-For Utility panel. You can concatenate up to four data sets that have like attributes. For example, all must be either sequential or partitioned.

```
Extended Search-For Concatenation Batch Entry

                                "Search" Concatenation
DS1 . . . _____
DS2 . . . _____
DS3 . . . _____
DS4 . . . _____

                                Other "Search" Partitioned, Sequential or VSAM Data Set
Data Set Name . . . _____
Volume Serial . . . _____ (If not cataloged)
Password . . . . . _____ (Password allowed only in foreground mode)

Command ==>>> _____
F1=Help      F2=Split    F3=Exit     F7=Backward F8=Forward  F9=Swap
F12=Cancel
```

Figure 143. Extended Search-For - concatenation batch entry panel (ISRSFCON)

This panel is the same as the panel shown in Figure 142 on page 240, except the Password field is omitted. If your data sets are password-protected, search the data sets in foreground mode by leaving the Option field on the Extended Search-For Utility panel blank.

If you selected the Batch option on the Extended Search-For Utility panel, the panel shown in Figure 140 on page 236 is displayed before the job is submitted. Use this panel to specify whether your Search-For listing is to be printed or written to a list data set.

Output Mode

The output mode you want to use when displaying the listing file. Choose one of these:

View This enables the listing file to be displayed in *view* mode. All View functions are enabled in this mode.

Browse

This enables the listing file to be displayed in the *browse* mode. All Browse functions are enabled in this mode.

Search-ForE utility (option 3.15)

Select Search-For process options

Table 15 lists all of the process options for Search-For.

Table 15. Search-For process options

ALLMEMS	ANYC	APNDLST	ASCII	CKPACKL	COBOL	Cpnnnnn
DPACMT	DPADCM	DPBLKCL	DPCBCMT	DPCPCMT	DPFTCMT	DPMACMT
DPPLCMT	DPPSCMT	FMSTOP	IDPFX	LMTO	LNFMTO	LONGLN
LPSF	LTO	MIXED	NOPRTCC	NOSEQ	NOSUMS	SDUPM
SEQ	XREF					

These rules govern the selection of Search-For process options:

- Type any nonblank character to the left of one or more process options. Then press Enter. This causes the options you specify to be displayed in the Process Options field on the Extended Search-For Utility panel. If you select two options that cannot be specified together, or if you enter an option name incorrectly, an error message is displayed. If **more +** or **more -+** is shown, use your Backward and Forward keys to move through the panel.
- Use the CANCEL command to return to the Extended Search-For Utility panel without processing selections.

Search-For process options can affect how the input data is processed, and determine the format and content of the output listing data set. They can also help you save processing time by avoiding comments and blank lines.

All these options except the DPxxxx (do not process) options can be chosen from the Search-For Process Options panel. However, you can type any of them in the Process Options field on the Extended Search-For Utility panel. Errors caused by mistyping process options are detected when you call the Extended Search-For utility.

For definitions of the Search-For process options, see "Process options" on page 461.

Edit Search-For statements data set

A statements data set consists of process statements that contain instructions for the SuperC program. They are similar to the process options, but are composed of a keyword and one or more operands. See "Select Search-For process options" for information about Search-For process options.

When you select 1 from the Options menu on the Extended Search-For Utility panel, the Extended Search-For utility displays the statements data set you specified in the Statements Dsn field. This data set is always displayed in Edit mode, allowing you to add, change, or delete search-for process statements as needed.

The size of the Edit window depends on the number of lines your terminal can display. The sample panel shown in Figure 144 on page 243 shows how the Edit window appears on a 24-line display. Examples of some common process statements are listed below the Edit window so you can easily compose the proper input line.

```

USERID.SRCHFOR.STMTS                               Columns 00001 00072

Enter or change Process Statements in the EDIT window below:
***** ***** Top of Data *****
.....
.....
.....
.....
.....
.....
.....
.....
.....
.....
***** ***** Bottom of Data *****

Examples      Explanation
SRCHFOR 'ABCD',W      Search for the word "ABCD"
SRCHFORC 'DEFG'      "DEFG" must be on same line as word "ABCD"
CMPCOLM 1:60 75:90   Search columns 1:60 and 75:90 for string(s)
DPLINE 'PAGE ',87:95 Exclude line if "PAGE " found in columns 87:99
DPLINE 'PAGE '       Exclude if "PAGE " found anywhere on line
SELECT MEM1,MEM2     Search only members MEM1 and MEM2 of PDS

- - - - -

Command ==> _____ Scroll ==> PAGE
F1=Help      F2=Split      F3=Exit      F5=Rfind      F6=Rchange   F7=Up
F8=Down      F9=Swap       F10=Left     F11=Right     F12=Cancel

```

Figure 144. Search-For process statements panel (ISRSFPRS)

The SuperC program validates the process statements at run time. Invalid process statements are not used and are noted at the bottom of the listing. Unless a higher return code is required by some other condition, a return code of 4 is returned.

For the syntax and examples of the Search-For process statements, see “Process statements” on page 472.

ISPF table utility (option 3.16)

The ISPF Table Utility (Option 3.16) provides functions for processing ISPF tables. When you select this option, the ISPF Table Utility entry panel is displayed. This panel allows you to specify a table data set or DD, a table name, and an option to be performed.

The Edit and Browse functions allow you to view the data in the rows of an ISPF table in full-screen mode (that is, multiple rows are displayed on a screen). Line commands allow you to work with individual or multiple table rows. Primary commands are provided to support processing against the entire table, including changing the format of the displayed data. Table data can be scrolled in any direction (up, down, left, or right). All table column values are displayed in scrollable fields, allowing columns to be scrolled left or right, and individual column values to be expanded and displayed in a popup window. The values for any extension variables associated with a particular table row can be displayed.

The Edit function allows you to change the data in a table simply by overtyping the displayed value. Edit function line commands are available to insert new table rows, repeat rows, and delete rows. Extension variables for a table row can be created, modified, or deleted.

The Export function writes the data in an ISPF table to a sequential file so that it can be browsed or edited. You can customize the format of the data written to the sequential file.

ISPF table utility (option 3.16)

The Import function uses the data in a sequential file to either create a new ISPF table or replace an existing table. The data in the sequential file is required to be in a special format generated by the ISPF Table Utility Export function.

```

  Menu  RefList  Utilities  Options  Help
-----
                                ISPF Table Utility
Option ==>> _____

      blank Display table list          E Edit table
      B Browse table                    I Import table data

Enter one of the parameters below:
Table Data Set . . TBUTIL.TABLES
or Table DD . . . _____ (Default is ISPTLIB)

Table Name . . . . _____ (Blank or pattern for table selection list)

Import Data Set _____

Enter "/" to select option
_ Open table in SHARE mode

F1=Help    F3=Exit    F12=Cancel  F13=Help    F15=End    F16=Return
F17=Rfind  F18=Rchange F22=Left   F23=Right   F24=Cretriev

```

Figure 145. ISPF Table Utility panel (ISRUTBP0)

Table Utility panel action bar

The Table Utility Panel action bar choices function as follows:

Menu For more information, see the details about the Menu Action Bar Choice in the ISPF User Interface topic in the *z/OS ISPF User's Guide Vol I*.

RefList

For information about referral lists, see the topic about Using Personal Data Set Lists and Library Lists in the *z/OS ISPF User's Guide Vol I*.

Utilities

For more information, see the details about the Utilities Action Bar Choice in the ISPF User Interface topic in the *z/OS ISPF User's Guide Vol I*.

Options

The Options pull-down offers these choices:

- 1 Table Utilities Options
- 2 Export Report Options
- 3 Export Data Set Attributes

Help The Help pull-down provides general information about Table Utility topics as well as information about each of the main panels and options.

Table Utility panel fields

The fields on the ISPF Table Utility panel are:

Table Data Set

The name of the data set containing the table you wish to process.

Table DD

The name of the DD allocated to your ISPF session which contains the table you wish to process.

The default is the ISPTLIB DD if you do not enter data for either the Table Data Set or Table DD. If you enter data in both the Table Data Set and Table DD fields, the Table Data Set takes precedence.

Table Name

The name of the table you wish to process.

If you leave this field blank or supply a pattern the table selection list will be displayed showing the matching tables in the table data set or DD.

Import Data Set

The name of the sequential data set containing the data used to create or replace a table through the Import function.

Open table in SHARE mode

Select this option if the table you choose to process is already open on another logical screen, or if you might need to share the table with another logical screen.

Table utility entry panel options

These are the options shown on the ISPF Table Utility entry panel:

Blank - (Display Table List)

If you leave the Option field blank, a list of tables for the Table Data Set or Table DD is displayed when the Table Name is either blank or contains a pattern. If a valid Table Name is entered, the table list is bypassed and the Edit/Browse panel is displayed.

B - (Browse Table)

If a valid Table Name for the Table Data Set or Table DD is entered, the Browse Table panel is displayed. If the Table Name is either blank or contains a pattern, the table list is displayed allowing you to select the table to be browsed.

E - (Edit Table)

If a valid Table Name for the Table Data Set or Table DD is entered, the Edit Table Display panel is displayed. If the Table Name is either blank or contains a pattern, the table list is displayed allowing you to select the table to be edited.

I - (Import Table Data)

The Import function uses data from a sequential data set to create a new ISPF table or update an existing ISPF table. You must supply a Table Data Set and Table Name for the new or updated table. The sequential data set containing the data that will be used to create or update the table must be specified in the Import Data Set field.

Table data set selection list

This selection list is displayed when you enter a table data set name and either no table name or a table name pattern on the table utility entry panel.

ISPF table utility (option 3.16)

```
Menu Utilities Options Help
-----
ISPF Table List                               Row 1 to 12 of 29
Command ==> _____ Scroll ==> CSR

List of tables in table library PDFTOOL.COMMON.TABLES

Name
-----
- BLG0CMDS
- BLG0KEYS
- BLG0PROF
- BLSGEDIT
- BLSGEDRT
- BLSGPROF
- BLSLPROF
- DAFCMDS
- ECXPDFPC
- HSQCMDS
- MOSCMDS
- MVS8CMDS
F1=Help      F2=Split    F3=Exit     F7=Backward F8=Forward  F9=Swap
F10=Actions  F12=Cancel
```

Figure 146. Table data set selection list panel (ISRUTBP1)

If no table name is supplied, all members in the table data set are shown in the selection list. If a table name pattern is supplied, all members in the table data set that have a name matching the pattern are shown in the selection list.

These line commands are available on the table data set selection list panel:

- E** The Edit line command displays the EDIT table panel. It is available if you did not enter an option on the table utility entry panel.
- B** The Browse line command displays the BROWSE table panel. It is available if you did not enter an option on the table utility entry panel.
- S** When you use the Select line command against a table, either the BROWSE table or EDIT table panel is displayed:
 - BROWSE table is displayed if you entered option B on the entry panel.
 - EDIT table is displayed if you entered option E on the entry panel.
 - If you did not enter option B or E on the entry panel, the panel is determined by how the option “Use EDIT as default to process selected table” is set. To set this option, select Table Utility Options panel from the Options pull-down.

These primary commands are available on the table data set selection list panel:

L *string*

The Locate command scrolls the selection list and positions at the top of the display the entry which either matches or precedes (in alphabetic sequence) the value of *string*.

S *tblname*

The Select command searches the selection list for an entry that matches *tblname*. If a matching entry is found the table is displayed in either the BROWSE table or EDIT table panel, following the same rules as for the Select line command.

E *tblname*

The Edit command is available if you did not enter an option on the table utility entry panel. The selection list is searched for an entry that matches *tblname*. If a matching entry is found the EDIT table panel is displayed.

B *tblname*

The Browse command is available if you did not enter an option on the table utility entry panel. The selection list is searched for an entry that matches *tblname*. If a matching entry is found the BROWSE table panel is displayed.

Table DD selection list

This selection list is displayed when you enter a table DD and either no table name or a table name pattern on the table utility entry panel.

Menu Utilities Options Help		
Command ==>		ISPF Table List Row 1 to 12 of 443
		Scroll ==> CSR
List of tables in data sets allocated to DD ISPTLIB		
Name	Concat. Number	Table Data Set
-----		-----
— \$ISRPROF	1	PDFDEV.LSACKV.TABLES
— #ISRPROF	1	PDFDEV.LSACKV.TABLES
— ABCPROF	7	LSACKV.ISPF.ISPPROF
— ACBKEYS	17	SYS1.DGTTLIB
— ADB2DB2D	9	SYS2.TABLES.SYSPLEXD
— ADB2PARM	23	DB2.ADMIN.V2R1M0.SADBTLIB
— ADB21D	23	DB2.ADMIN.V2R1M0.SADBTLIB
— ADB21DI2	23	DB2.ADMIN.V2R1M0.SADBTLIB
— ADB21S	23	DB2.ADMIN.V2R1M0.SADBTLIB
— ADB21SP	23	DB2.ADMIN.V2R1M0.SADBTLIB
— ADB21T	23	DB2.ADMIN.V2R1M0.SADBTLIB
— ADB21X	23	DB2.ADMIN.V2R1M0.SADBTLIB
F1=Help	F2=Split	F3=Exit F7=Backward F8=Forward F9=Swap
F10=Actions	F12=Cancel	

Figure 147. Table DD selection list panel (ISRUTBP2)

If no table name was supplied, all members in the data sets allocated to the table DD are shown in the selection list. If a table name pattern was supplied, all members in the data sets allocated to the table DD which have a name matching the pattern are shown in the selection list.

The table DD selection list is sorted in member name order. Along with the member name, the selection list displays the name of the table data set where the member was found, and the concatenation number for that data set within the table DD.

These line commands are available on the table DD selection list panel:

- E** The Edit line command displays the EDIT table panel. It is available if you did not enter an option on the table utility entry panel.
- B** The Browse line command displays the BROWSE table panel. It is available if you did not enter an option on the table utility entry panel.
- S** When you use the Select line command against a table, either the BROWSE table or EDIT table panel is displayed:
 - BROWSE table is displayed if you entered option B on the entry panel.
 - EDIT table is displayed if you entered option E on the entry panel.

ISPF table utility (option 3.16)

- If you did not enter option B or E on the entry panel, the panel is determined by how the option “Use EDIT as default to process selected table” is set. To set this option, select Table Utility Options panel from the Options pull-down.

These primary commands are available on the table data set selection list panel:

L *string*

The Locate command scrolls the selection list and positions at the top of the display the entry which either matches or precedes (in alphabetic sequence) the value of *string*.

S *tblname*

The Select command searches the selection list for an entry that matches *tblname*. If a matching entry is found the table is displayed in either the BROWSE table or EDIT table panel, following the same rules as for the Select line command.

E *tblname*

The Edit command is available if you did not enter an option on the table utility entry panel. The selection list is searched for an entry that matches *tblname*. If a matching entry is found the EDIT table panel is displayed.

B *tblname*

The Browse command is available if you did not enter an option on the table utility entry panel. The selection list is searched for an entry that matches *tblname*. If a matching entry is found the BROWSE table panel is displayed.

Edit/browse table panel

The table display panel used for the Edit and Browse functions of the table utility shows multiple rows on the one screen. Each row occupies one line on the screen. The UP and DOWN primary commands allow you to scroll through the rows in a table.

Options		Help			
BROWSE		ISPF Table BLSGEDIT		Row 1 to 15 of 17	
Command ==>				Scroll ==> CSR	
				Shift ==> PAGE	
ZEDPTYPE	ZEDPLRCL	ZEDPRCFM	ZEDPFLAG	ZEDPBNDL	ZEDPBNDR
----	----	----	-----1-----2-----	----	----
— TRACE	128	F	000000101000000000010000	0	0
— CLIST	251	V	010000000000100000010000	0	0
— PANELS	80	F	000000101000100000010000	0	0
— TRACE	72	F	000000101000000000010000	0	0
— CNTL	80	F	000000001000100000010000	0	0
— JCL	80	F	010000000000100000010000	0	0
— VCALL	80	F	000000001000000000000000	0	0
— TRACE	121	V	000000001000000000000000	0	0
— F02	80	F	000000001000000000000000	0	0
— F03	121	V	000000001000000000000000	0	0
— PRINT1	129	V	000000001000000000000000	0	0
— TEXT	251	V	010000000000000000000000	0	0
— ISPVCALL	80	V	000000000000000000000000	0	0
— TRACE	80	F	000000000000000000000000	0	0
— LOG	121	V	000000000000000000000000	0	0
F1=Help	F3=Exit	F4=Expand	F5=Rfind	F12=Cancel	F13=Help
F15=End	F16=Return	F17=Rfind	F22=Left	F23=Right	F24=Cretriev

Figure 148. Table display panel, edit mode (ISRUTBP3)

The dialog variables for the table rows are displayed in columns across the screen, with the dialog variable names shown as column headings. The RIGHT and LEFT primary commands allow you to view any columns that are not currently visible.

Two options on the Table Utility Options panel control how key values are displayed:

- Color used to display table key values specifies the color (BLUE, RED, PINK, GREEN, TURQ, YELLOW, or WHITE).
- Intensity used to display table key values specifies the intensity (HIGH or LOW).

The default color is GREEN and the default intensity is HIGH. For the Edit function, key values are always underscored. For the Browse function, key values are not underscored.

To determine the width required for each column field, the table utility must scan the table rows and check the length of the table variable values. While the utility uses an efficient method to scan a table, this process can be time consuming for a table with an extremely large number of rows. You can limit the number of rows scanned through the "Maximum rows searched to determine column width" option on the Table Utility Options panel.

All table variables are displayed in scrollable fields, with a scale indicator displayed below each column heading. Using scrollable fields allows the EXPAND primary command to be used to display the value of a table variable in a popup window. This popup window can display and edit data in HEX mode. The scrollable fields also allow you to use the RIGHT and LEFT primary commands to horizontally scroll column values.

For the Browse function, all the fields displaying table variable values are protected. For the Edit function, all these fields are unprotected and you can make changes to the table variable values by overtyping the displayed data.

For the Edit function, when you press Exit (F3) the changes are saved to a table output library. Normally the changes would be saved to the originating data set.

If you specified the table name and a Table DD on the ISPF Table Utility panel, and the "Always save table in originating data set" check box on the Table Utility Options panel is not selected, ISPF prompts you to specify the output data set. See "Table output data set selection" on page 260 for more information.

Line commands

This topic describes the line commands available on the Edit/Browse panel.

- E** Extension Variables. Use this command to display the extension variables for the table row. When using the Edit function, the values of the extension variables can be changed, new extension variables can be created, and existing extension variables can be deleted. See "Extension Variables panel" on page 250.
- In** Insert Row After. Use this command to insert one or more rows after the row where the line command was entered. The table variable values for an inserted row are initialized with blanks.
- Bn** Insert Row Before. Use this command to insert one or more rows before the row where the line command was entered. The table variable values for an inserted row are initialized with blanks.

ISPF table utility (option 3.16)

Rn Repeat Row. Use this command to create one or more copies of the table row. The copied rows are inserted after the row where the line command was entered. For the copied rows, all variables excluding keys are initialized using the values from the corresponding variables in the row where the line command was entered. Key variables are initialized with blanks.

Dn Delete Row. Use this command to delete one or more table rows.

Note:

1. The E command is available in both the Edit and Browse functions. The I, B, R, and D commands are only available in the Edit function.
2. For all line commands except E, an optional number from 1 to 9 can be entered as a suffix to the line command character. This causes the command to operate on multiple rows starting with the row on which the command was entered.
3. When processing a keyed table, the optional number is ignored for the line commands I, B, and R.

Extension Variables panel: The Extension Variables panel shows the names and values of the extension variables defined for a table row. To display the extension variables panel, enter the E line command against a table row on the table display screen.

```
Options Help
-----
Command ==> BLSGEDIT Extension Variables for Row 1 Row 1 to 3 of 3
Scroll ==> CSR

Extension variable values scrollable width: 65
S Name Value
-- -----
-- +-----1-----2-----3-----4-----5-----6-----+
ZEDPIMAC
ZEDPFLG2 01000011
ZEDPFLG3 00000001
***** Bottom of data *****

F1=Help F2=Split F3=Exit F4=Expand F5=Rfind F7=Up F8=Down
F9=Swap F10=Left F11=Right F12=Cancel
```

Figure 149. Extension Variables Panel (ISRUTBP4)

When you edit a table, the extension variable names and their values and the “Extension variable values scrollable width” are displayed in unprotected fields. You can change the extension variable names and values by overtyping the displayed data. You can use the selection field to enter a line command against an extension variable. When you browse a table, the extension variable names and values are protected, and the selection field is unavailable.

The extension variable values are displayed in scrollable fields with a scale indicator displayed below the column heading. You can use the RIGHT and LEFT primary commands to horizontally scroll through one of the values. You can enter

the EXPAND primary command to display the value of an extension variable in a popup window. This popup window also enables you to display and edit data in HEX mode.

The “Extension variable values scrollable width” field initially displays the length of the scrollable width of the field that displays the extension variable values. This length will be the maximum of either:

- The length of the field displaying the values. This length depends on the width of the screen. For example, if the screen has a width of 80 characters the field will have a length of 65 characters. For a screen with a width of 132 characters the field will have a length of 117 characters.
- The length of the largest value for the extension variables displayed.

If you need to lengthen the value for an extension variable beyond the scrollable limit, you can use this field to enter a numeric value to increase the scrollable width of the field. You can then use the EXPAND primary command (F4) to update the value of the extension variable.

Line commands: This topic describes the line commands available on the Extension Variables panel.

- In** Insert Extension Variable After. Use this command to insert one or more extension variables after the row where the line command was entered. The name and value for the inserted extension variable are initialized with blanks.
- Bn** Insert Extension Variable Before. Use this command to insert one or more extension variables before the row where the line command was entered. The name and value for an inserted extension variable are initialized with blanks.
- Rn** Repeat Extension Variable. Use this command to create one or more copies of the extension variable. The extension variables are inserted after the row where the line command was entered. For the new extension variables, the names and values are copied from the extension variable where the line command was entered.
- Dn** Delete Extension Variable. Use this command to delete one or more extension variables.

Note:

1. Line commands on the extension variables panel are only available when using the Edit function.
2. For all line commands, an optional number from 1 to 9 can be entered as a suffix to the line command character. This causes the command to operate on multiple extension variables starting with the extension variable against which the command was entered.

Primary commands

This topic describes the primary commands available on the Table Utility Edit/Browse panel:

Navigating through the table

- UP
- DOWN
- LEFT
- RIGHT
- FIND

ISPF table utility (option 3.16)

- RFIND

Changing the data or how it is displayed

- INSERT
- EXPAND
- SORT
- STATS
- STRUCT

Saving or exporting table data

- SAVE
- CANCEL
- EXPORT
- FEXPORT

Browse and Edit primary commands are entered in the Command field. All the primary commands except SAVE are available in both the Edit and Browse functions. The SAVE command is only available in Edit.

CANCEL

Terminate Edit without Saving Changes. The CANCEL command (F12) terminates table editing without saving the table data to the output data set.

CAN can be used as an abbreviation for the CANCEL command.

DOWN

Scroll Down. The standard ISPF DOWN command (F8|F20) can be used to vertically scroll the table display towards the bottom of the table.

ISPF supported scroll amount values used for the DOWN command can be entered in the Scroll field. You can also enter a valid scroll amount in the Command field.

EXPAND

Expand Display of Scrollable Field. The standard ISPF EXPAND command (F4) can be used to display a table variable value in a popup window containing a scrollable dynamic area. To do this, enter EXPAND while the cursor is placed on the field displaying a table variable value.

EXPORT

Display Table Export Layout. The Export Layout panel is displayed when the EXPORT primary command is entered on the Edit/Browse panel. This panel shows the structure used to format the table data written to the export output data set. You can make changes to the structure to alter the format of the data written to the output data set.

Order	Name	Field Heading	Width	Cumulative Width
001	ZEDPTYPE	ZEDPTYPE	8	9
002	ZEDPLRCL	ZEDPLRCL	8	18
003	ZEDPRCFM	ZEDPRCFM	8	27
004	ZEDPFLAG	ZEDPFLAG	24	52
005	ZEDPBNDL	ZEDPBNDL	8	61
006	ZEDPBNDR	ZEDPBNDR	8	70
007	ZEDPTABC	ZEDPTABC	8	79
008	ZEDPMASK	ZEDPMASK	8	88
009	ZEDPTABS	ZEDPTABS	8	97

***** Bottom of data *****

F1=Help F2=Split F3=Exit F7=Backward F8=Forward F9=Swap
F10=Actions F12=Cancel

Figure 150. Table Export Layout panel (ISRUTBP7)

The screen shows the current structure used to format the table data written to the export data set. The list contains these fields:

Order This input field allows you to enter a number which defines the sequence in which the table variables for each row are placed in the export data set. For example, assigning an Order of 001 to a table variable makes it the first to be written to each table data record in the export data set.

Note: Only table variables that have an Order value less than 999 are written to the export data set.

Name The name of the table variable.

Field Heading

This input field allows you to define a heading for each table variable written to the export data set. It is initialized with the name of the associated table variable.

Width This input field allows you to define the number of characters allocated to the column used to print a table variable value. This field is initialized to the display length of the table variable value on the table display screen.

Cumulative Width

This field shows the total number of characters required in the export data set record to accommodate this variable and all the preceding table variables.

When you are happy you have the correct format defined, use the FILE primary command to write the table data to the export data set.

These abbreviations can be used for the EXPORT command:

EX
EXP
EXPO
EXPOR

ISPF table utility (option 3.16)

FILE The FILE command causes the table data to be written to the export data set in the format defined on the export layout panel.

The name of the export output data set can be specified as a parameter to the FILE command. You can enter any fully qualified data set name by enclosing it in apostrophes. If you omit the apostrophes, your TSO prefix or user ID (if no TSO prefix is defined in your TSO user profile) is added to the beginning of the data set name. For example, if a user whose TSO prefix is LSACKV issues the command FILE TAB1.DATA, the table data report is written to the export data set LSACKV.TAB1.DATA.

If you do not specify an export data set name on the FILE command, a default name is generated according to these rules:

- If no TSO prefix is defined in your TSO user profile:
userid.tblname.TBLDUMP
- If your TSO prefix and user ID are the same:
tsopref.tblname.TBLDUMP
- If your TSO prefix and user ID are not the same:
tsopref.userid.tblname.TBLDUMP

tsopref is your TSO prefix. *userid* is your TSO user ID. *tblname* is the name of the table you are processing.

Note: If the ISPF configuration table field USE_ADDITIONAL_QUAL_FOR_PDF_DATA_SETS is set to YES, an additional qualifier defined with the ISPF_TEMPORARY_DATA_SET_QUALIFIER field is included before the *tblname* qualifier.

A warning message might be displayed if the export data set already exists. You then have the option of terminating the command to avoid overwriting the data set. If you don't want to receive these warnings in future, clear the "Warn if export data set exists" check box on the Table Utility Options panel.

When the FILE command has finished, the export data set is displayed. The "Display mode for export data set" option on the Table Utility Options panel allows you to choose either the ISPF Browse, View, or Edit functions to display the export data set.

These abbreviations can be used for the FILE command:

FI
FIL

FEXPORT

Fast EXPORT Command. The FEXPORT command writes the table data to the export output data set without displaying the export layout panel.

The name of the export output data set can be specified as a parameter to the FEXPORT command. You can enter any fully qualified data set name by enclosing it in apostrophes. If you omit the apostrophes, your TSO prefix or user ID (if no TSO prefix is defined in your TSO user profile) is added to the beginning of the data set name. For example, if a user whose TSO prefix is LSACKV issues the command FEXPORT TAB1.DATA, the table data report is written to the export data set LSACKV.TAB1.DATA.

If you do not specify an export data set name on the FEXPORT command, a default name is generated according to these rules:

- If no TSO prefix is defined in your TSO user profile:
userid.tblname.TBLDUMP
- If your TSO prefix and user ID are the same: *tsopref.tblname.TBLDUMP*
- If your TSO prefix and user ID are not the same:
tsopref.userid.tblname.TBLDUMP

tsopref is your TSO prefix. *userid* is your TSO user ID. *tblname* is the name of the table you are processing.

Note: If the ISPF configuration table field `USE_ADDITIONAL_QUAL_FOR_PDF_DATA_SETS` is set to YES, an additional qualifier defined with the `ISPF_TEMPORARY_DATA_SET_QUALIFIER` field is included before the *tblname* qualifier.

If the export data set exists when the FEXPORT command is issued and you have selected “Warn if export data set exists” on the Table Utility Options panel, a warning popup panel is displayed. You then have the option of terminating the command to avoid overwriting the data set.

When the FEXPORT command has finished, the export data set is displayed. The “Display mode for export data set” option on the Table Utility Options panel allows you to choose either the ISPF Browse, View, or Edit functions to display the export data set.

These abbreviations can be used for the FEXPORT command:

```
FE
FEX
FEXP
FEXPO
FEXPOR
```

FIND Search for String in Table. The FIND command can be used to search for the occurrence of a character string in a specified column in the table. If the string is found, the row in which it is found is positioned at the top of the display.

The FIND command has these formats:

```
FIND varname string
FIND n string
```

where:

varname

The name of any of the table variables.

n

The ordinal number of any column displayed on the current screen.

string

The character string to be searched for. The search is not case sensitive.

These abbreviations can be used for the FIND command:

```
F
FI
FIN
```

INSERT

Insert a Blank Row at the Top of the Table. Use the INSERT command to create a new blank row as the first row in the table. This command allows you to create a row in an empty table.

ISPF table utility (option 3.16)

LEFT Scroll Left. The LEFT command (F10 | F22) can be used to scroll the table display horizontally towards the first table column.

The scroll amount values used for the LEFT command can be entered in the Shift field. You can also enter one of these valid scroll amounts in the Command field:

PAGE Causes the display to scroll left by the width of the screen.

MAX Causes the display to scroll left so that the first column for the table is the leftmost displayed.

0 to 9999

Causes the display to scroll left the specified number of columns.

Note: Table variable values are displayed in scrollable fields. Therefore if the cursor is placed in a field displaying a table variable value, the LEFT command operates on that field, not on the whole table display.

RFIND

Repeat Last FIND Command. The RFIND command (F5 | F17) is used to repeat the last FIND command. It is most useful when assigned to a function key.

R can be used as an abbreviation for the RFIND command.

RIGHT

Scroll Right. The RIGHT command (F11 | F23) can be used to scroll the table display horizontally towards the last table column.

The scroll amount values used for the RIGHT command can be entered in the Shift field. You can also enter one of these valid scroll amounts in the Command field:

PAGE Causes the display to scroll right by the width of the screen.

MAX Causes the display to scroll right so that the last column for the table is the rightmost displayed.

0 to 9999

Causes the display to scroll right the specified number of columns.

Note: Table variable values are displayed in scrollable fields. Therefore if the cursor is placed in a field displaying a table variable value, the RIGHT command operates on that field, not on the whole table display.

SAVE Save Table Changes. The SAVE command causes the changes to the table data to be written to the table output library. Normally the changes would be saved to the originating data set.

If you specified the table name and a Table DD on the ISPF Table Utility panel, and the "Always save table in originating data set" check box on the Table Utility Options panel is not selected, ISPF prompts you to specify the output data set. See "Table output data set selection" on page 260 for more information.

SAV can be used as an abbreviation for the SAVE command.

SORT Display Table Sort Definition. The Sort Specification panel is displayed when the SORT primary command is entered on the Edit/Browse panel. This panel allows you to sort the table according to the values of one or more table variables.

```

Options Help
-----
Table BLSGEDIT Sort Specification          Row 1 to 9 of 9
Command ==> _____ Scroll ==> CSR

Overtyp e the Order column and press ENTER to rearrange the table variables
into the order in which you would like them to be sorted. Change Sequence to A
(Ascending) or D (Descending) as required. Table BLSGEDIT will only be sorted
using table variable with an Order less than 999.

Order      Name          Sequence (A/D)
-----
999      ZEDPTYPE          A
999      ZEDPLRCL          A
999      ZEDPRCFM          A
999      ZEDPFLAG          A
999      ZEDPBNDL          A
999      ZEDPBNDR          A
999      ZEDPTABC          A
999      ZEDPMASK          A
999      ZEDPTABS          A
F1=Help   F2=Split   F3=Exit   F7=Backward F8=Forward F9=Swap
F10=Actions F12=Cancel

```

Figure 151. Table Sort Specification panel (ISRUTBP8)

The screen displays a list of the table variables and contains these fields:

Order This input field allows you to enter a number which defines the sort priority for the associated table variable. For example, assigning an Order of 001 makes the associated table variable the primary sort key.

Note: The table will only be sorted on those variables that have an Order value less than 999.

Name The name of the table variable.

Sequence (A/D)

This input field allows you to define whether to sort in ascending (A) or descending (D) sequence for the associated table variable.

When you press Exit (F3) to return to the Edit/Browse panel it is sorted based on changes made on the table sort display.

Note: If you are using Edit, the sort criteria entered on this screen are saved with the table.

These abbreviations can be used for the SORT command:

```

S0
SOR

```

STATS

Display Table Statistics. The table statistics display is invoked when the STATS primary command is entered on the browse/edit table display. This screen shows the statistical information that ISPF maintains for the table.

```

                                Statistics for Table BLG0CMDS
Command ==> _____
The following information is returned by the TBSTATS service:

Created on . . . : 1997/01/14 at 13:26:23
Last updated on : 2004/08/27 at 09:37:02 by LSACKV

Initial number of rows when created . . . . . : 101
Current number of rows . . . . . : 101
Number of existing rows which have been updated : 2
Number of times table has been updated . . . . . : 7
Virtual storage size (bytes) . . . . . : 8,072

Last TABLE SERVICES command . . . . . : TBTOP
Return code from above service . . . . . : 0

Status 1 : 1 - table exists in input library chain
Status 2 : 3 - table is open in WRITE mode in this logical screen
Status 3 : 2 - table is not available for WRITE mode

F1=Help      F2=Split      F3=Exit      F7=Backward  F8=Forward
F9=Swap      F10=Actions   F12=Cancel

```

Figure 152. Table statistics panel (ISRUTBP6)

The screen shows these fields:

Created on

The date and time the table was originally created.

Last updated on

The date and time the table was last modified.

by

User ID of the last user who modified the table.

Initial number of rows when created

Number of rows that were added during the session when the table was first created and then closed.

Current number of rows

Number of rows currently in the table.

Number of existing rows which have been updated

Number of rows that have been modified in the table at least once. A row that is added to an existing table is considered a modified row.

Number of times table has been updated

Number of editing sessions during which the table has been modified. Opening a table, then making one or more updates, then closing and saving the table increments this count by one.

Virtual storage size (bytes)

Number of bytes of virtual storage required by the table.

Last TABLE SERVICES command

The name of the last table service called.

Return code from above service

The return code issued by the last table service called.

Status 1

The status of the table in the table input library chain.

Status 2

The status of the table in this logical screen.

Status 3

The availability of the table to be used in WRITE mode.

STRUCT

Display Table Structure. The table structure panel is invoked when the STRUCT primary command is entered on the Edit/Browse panel. This panel shows the structure used to format the browse/edit table display. You can change the data displayed on this screen to alter the format of the table display.

```

Options Help
-----
Command ==> _____ Structure of Table BLSGEDIT Row 1 to 7 of 9
                               Scroll ==> CSR

Number of Rows . . . : 17      Rows scanned to produce
Number of Keys . . . : 0      structure . . . . . : 17
Number of Names . . . : 9

-----
ZEDPTYPE ZEDPLRCL ZEDPRCFM ZEDPFLAG          ZEDPBNDL ZEDPBNDR
-----

Column Name      Type Length Display Area
-----
001 ZEDPTYPE Name 8 <= start of display
002 ZEDPLRCL Name 8 <= displayed
003 ZEDPRCFM Name 8 <= displayed
004 ZEDPFLAG Name 24 <= displayed
005 ZEDPBNDL Name 8 <= displayed
006 ZEDPBNDR Name 8 <= end of display
007 ZEDPTABC Name 8
F1=Help F2=Split F3=Exit F7=Backward F8=Forward F9=Swap
F10=Actions F12=Cancel

```

Figure 153. Table structure panel (ISRUTBP5)

The top area of this screen shows this information about the table:

- Number of Rows
- Number of Keys
- Number of Names
- Rows scanned to produce structure

Note: This value is controlled by the “Maximum rows searched to determine column width” option on the Table Utility Options panel.

The next area of the screen shows the current column headings for the table display.

The bottom area of the screen shows the current structure used to format the table display. This is a list containing these fields:

Column

This input field shows a number representing the relative position of the associated table variable in the table display. You can change the position of a variable in the table display by altering this number.

Name The name of the table variable.

Type Shows a value of Key if the associated variable is defined as a key for the table. Otherwise shows a value of Name.

ISPF table utility (option 3.16)

Length

This input field shows the number of characters used to display the table variable value. The table utility calculates this number by scanning the table rows and finding the largest length value for each table variable.

Note: If you have specified a value for the “Maximum rows searched to determine column width” option on the Table Utility Options panel, the table utility might not scan all the table rows and therefore the calculated length value might not be large enough for all variable values.

Display Area

Identifies the table variables currently shown on the table display screen.

When you press Exit (F3) to return to the Edit/Browse panel it is reformatted based on changes made on the table structure display.

These abbreviations can be used for the STRUCT command:

STR
STRU
STRUC

UP Scroll Up. The standard ISPF UP command (F7|F19) can be used to vertically scroll the table display towards the top of the table.

ISPF supported scroll amount values used for the UP command can be entered in the Scroll field. You can also enter a valid scroll amount in the Command field.

Table output data set selection

This panel is displayed when either the first SAVE command is issued or the EXIT command (F3) is issued, and these conditions are all true:

- The table you have modified was specified on the Table Utility Entry panel
- you did not select “Always save table in originating data set” on the Table Utility Options panel
- you specified a Table DD rather than a Table Data Set on the Table Utility Entry panel

```

Help
-----
Table Output Data Set Selection      Row 1 to 7 of 2
Command ==> _____ Scroll ==> CSR

No table data set was originally specified, only a table DD. Since there was
more than one table data set allocated to this DD, please select which data
set should receive the updated table. All future SAVE requests will
automatically use the selected table data set. Use END or CANCEL to return
without saving the table.

S Table Data Set
-----
- PDFTDEV.LSACKV.TABLES
- PDFTOOL.COMMON.TABLES
- PDFTDEV.STG.TABLES
- PDFTDEV.INT.TABLES
- PDFTDEV.SVT.TABLES
- ISPFTEST.TABLES
- LSACKV.ISPF.ISPPROF
- MBURNS.ISPF.ISPPROF
F1=Help      F2=Split      F3=Exit      F7=Backward  F8=Forward  F9=Swap
F10=Actions  F12=Cancel

```

Figure 154. Table Output Data Set Selection panel (ISRUTBP9)

This panel lists the data sets allocated to the table DD specified on the table utility entry panel. Enter an S in the selection field for the data set in which you would like the updated table to be saved. If you press Enter without selecting a data set, the table update is canceled.

Table utility options

To display the Table Utility Options panel, select Table Utility Options from the Options menu on the action bar. This panel allows you to set options that control certain behaviors within the ISPF Table Utility.

These options on the first section of the panel affect the Edit and Browse functions:

Open table in SHARE mode

Select this option if the table you are to process is already open on another logical screen or if you might need to share the table with another logical screen.

Use EDIT as default to process selected table

When you select this option, you will default to Edit mode if you do not specify either the Edit or Browse functions on the table utility entry panel or the table selection panel. You will default to browse mode when this option is not selected.

Always save table in originating data set

When this option is selected: If the table you are editing was specified on the table utility entry panel but the Table data set was not specified, the table is automatically saved in the original data set.

When this option is cleared: When you first attempt to save the table, the table output data set selection panel will be displayed. This panel allows you to choose within the table DD the data set where the table will be saved.

Maximum rows searched to determine column width

To determine the width required to display each column field, the table utility scans the table rows and checks the length of the table variable

ISPF table utility (option 3.16)

values. This option allows you to specify a number which acts as the limit for the number of rows scanned in this process. If you leave this value blank, all rows will be scanned.

Note: Because the table utility uses an efficient method to scan a table, you can leave this option blank for all but extremely large tables.

Color used to display table key values

Use this option to specify the color (BLUE, RED, PINK, GREEN, TURQ, YELLOW, or WHITE) used to display the values for the key variable in the table. The default is GREEN.

Intensity used to display table key values

Use this option to specify the intensity (HIGH or LOW) used to display the values for the key variables in the table. The default is HIGH.

These options on the second section of the panel affect the Import function:

Warn if table exists in the output library

When this option is selected, a warning message will be displayed if you try to import data into a table that already exists in the specified output data set. You can then choose either to overwrite the existing table or to cancel the import process. If you don't want to receive warning messages in this situation, clear this option.

Use Edit to view the imported table

When this option is selected, the table utility uses the Edit function to display the table that was created or updated by the Import function. If this option is not set, the Browse function will be used to display the table.

These options on the final section of the panel affect the Export function:

Warn if export data set exists

When this option is selected, a warning message will be displayed if the data set you are exporting table data into already exists. You can then choose either to overwrite the data set or to cancel the export process. If you don't want to receive warning messages in this situation, clear this option.

Display mode for export data set

This option allows you to choose whether to use either the ISPF Browse, View, or Edit function to display the export data set after the export process has completed.

Table export report options

To display the Table Export Reports Options panel, select Export Report Options from the Options menu on the action bar. This panel allows you to set options which control the format of the report written to the output data set by the table utility Export function.

```

Table Export Report Options
Command ==> _____

Enter "/" to select option
_ Set options to match IMPORT format report

/ Generate headings
/ Underline headings

Heading, column and page spacing:

Blank lines after heading . . . . . 0 (0 - 9)
Number of spaces between columns . . 1 (0 - 99)
Number of lines per page . . . . . 0 (0 - 99)
                                     (0 if no paging is required)
Number of blank lines between pages 0 (0 - 99)
                                     (ignored if lines/page = 0)

Enter END to save changes.
Enter CANCEL to cancel changes.
F1=Help      F2=Split      F3=Exit      F7=Backward  F8=Forward
F9=Swap      F12=Cancel

```

Figure 155. Table Export Report Options panel (ISRUTBO2)

The panel provides these options:

Set options for IMPORT format report

Select this option if you want to write the export report in the same format that is used by the table utility Import function. Selecting this option causes other options on the panel to be set so as to produce the export report in the appropriate format.

Generate headings

Select this option if you want the export report to have headings for the columns showing the table variable values.

Underline headings (in export report)

Select this option if you want the column headings to be underlined. Column headings for key variables are underlined with plus signs (+++++). Column headings for non-key variables are underlined with dashes (-----).

Blank lines after heading

This option allows you to specify the number of blank lines printed after the column headings. The number must be between 0 and 9.

Number of spaces between columns

This option allows you to specify the number of spaces printed between the columns showing the table variable values. The number must be between 0 and 99.

Number of lines per page

This option allows you to specify the maximum number of lines printed on each page of the report. The number must be between 0 and 99. If you specify 0, no page breaks will be generated.

Number of blank lines between pages

This option allows you to specify the number of blank lines printed at the

ISPF table utility (option 3.16)

end of a page to separate it from the following page. The number must be between 0 and 99. This option is ignored if you specify 0 for the "Number of lines per page" option.

Export data set attributes

To display the Export Data Set Attributes panel, select Export Data Set Attributes from the Options menu on the action bar. This panel allows you to set various attributes for the output data set created by the table utility Export function.

```
Export Data Set Attributes
Command ==> _____
Management class . . . _____ (Blank for default management class)
Storage class . . . . . _____ (Blank for default storage class)
Volume serial . . . . . _____ (Blank for system default volume) **
Device type . . . . . SYSALLDA (Generic unit or device address) **
Data class . . . . . _____ (Blank for default data class)
Space units . . . . . TRACK (BLKS, TRKS, or CYLS)
Primary quantity . . 5 (In above units)
Secondary quantity 5 (In above units)

( ** Only one of these fields may be specified)

Enter END to save changes.
Enter CANCEL to cancel changes.

F1=Help      F2=Split     F3=Exit      F7=Backward  F8=Forward
F9=Swap      F12=Cancel
```

Figure 156. Table Export Data Set Attributes panel (ISRUTBO3)

The panel provides these options:

Management class

Specify the SMS management class for the data set. The management class is used to obtain data management-related information for the data set, such as migration, backup, and retention criteria.

Storage class

Specify the SMS storage class for the data set. The storage class is used to obtain storage-related information (volume serial) for the data set.

Volume serial

For a non-SMS data set, specify the volume serial of the direct-access volume you wish to contain the data set.

Device type

For a non-SMS data set, specify the generic unit address for the direct access volume you wish to contain the data set.

Data class

Specify the SMS data class for the data set. The data class is used to obtain data-related information (space units, primary quantity, secondary quantity, directory block, record format, record length, and data set name type) for the data set.

Space units

Specify the disk space units (TRACK, CYLINDER, or BLOCK).

Primary quantity

Enter a number for the primary allocation in space units.

Secondary quantity

Enter a number for the secondary allocation in space units.

Importing data into a table

The ISPF Table Utility supports an Import function, where data in a sequential data set is used to load an ISPF table. The import function is invoked by entering option I (Import table data) on the ISPF Table Utility entry panel.

When you use the Import function, enter these fields on the table utility entry panel:

Table Data Set

This identifies the data set where the table that will be created or updated by the Import function is saved.

Table Name

The name of the table that will be created or updated by the Import function.

Import Data Set

The name of the data set containing the data used as input to the Import function.

The Import function requires the Import Data Set to contain a report in a specific format. This format is generated by the ISPF table utility Export function and has these features:

- The variable name is used as a heading for each column showing the values for the table variables.
- The headings are underlined. Column headings for key variables are underlined with plus signs (+++++++). Column headings for non-key variables are underlined with dashes (-----).
- There are no blank lines after headings.
- There is only 1 space between columns.
- There is no paging.

A warning message might be displayed if the table you specify already exists in the Table Data Set. You then have the option of terminating the command to avoid overwriting the table. If you don't want to receive these warnings in future, clear the "Warn if table exists in the output library" check box on the Table Utility Options panel.

When the import process has finished, the table that was created or updated is displayed. The "Use Edit to view the imported table" option on the Table Utility Options panel allows you to choose either the table utility Edit or Browse function to display the imported table. The default is Browse.

Exporting data from a table

The ISPF Table Utility supports an Export function, where data in an ISPF table is used to write a customizable report to a sequential file. The Export function is invoked by using either the EXPORT or FEXPORT primary commands from the table display screen for the table utility Edit and Browse functions.

ISPF table utility (option 3.16)

Note: The report does not show the values for extension variables defined for table rows.

The EXPORT primary command displays the Export Layout panel, where you can control the layout of the table data in these ways:

- Exclude table variables from the report
- Change the order in which the table variables appear in the report
- Change the column headings

The Table Export Report Options panel allows you to change the format of the report. Selecting the "Set options for IMPORT format report" option ensures the generated report is in a format that can be processed by the table utility Import function. The Export Data Set Attributes panel allows you to define the allocation attributes for the export data set.

Figure 157 shows an example of the export report in a format suitable for the Import function:

```
***** Top of Data *****
SUBSYS  SERVER  DESCRIPT                                BSECEXIT BCATOWN BJCLASS BJS
+++++++  -----
DB2D           DB2 Version 5                                A
DB26           DB2 Version 6 - Subsystem 1                    A
DB62           DB2 Version 6 - Subsystem 2                    A
DB27           DB2 Version 7                                A
DBT5           DB2 Version 5.1 for FM/DB2 FVT only              A
DBT6           DB2 Version 6.1 for FM/DB2 FVT only              A
DBT7           DB2 Version 6.1 for FM/DB2 FVT only              A
***** Bottom of Data *****
```

Figure 157. Export report example

Processing tables that are currently open

Normally, ISPF does not allow a table to be opened and processed if that table is currently open. However, if the table currently open has been opened with the SHARE option, a subsequent open of the table is allowed if:

- The SHARE option is used, and
- The WRITE/NOWRITE option is the same as specified when the table was initially opened

The ISPF Table Utility provides support which allows you to process a table even when that table is currently open.

If a table is currently open in SHARE mode, the ISPF Table Utility can be used to process that table provided you select the "Open table in SHARE mode" option on the ISPF Table Utility panel *and* the Edit (WRITE) or Browse (NOWRITE) option specified matches the WRITE/NOWRITE setting when the table was originally opened.

If a table data set (rather than a table DD) is specified on the entry panel, the ISPF Table Utility also allows you to process a table that is open but not in SHARE mode, or a table that is open in SHARE mode but the WRITE/NOWRITE (edit/browse) setting does not match that of the open table. When this situation is detected, one of the popup windows shown here is displayed allowing you to specify the way in which to process the table:

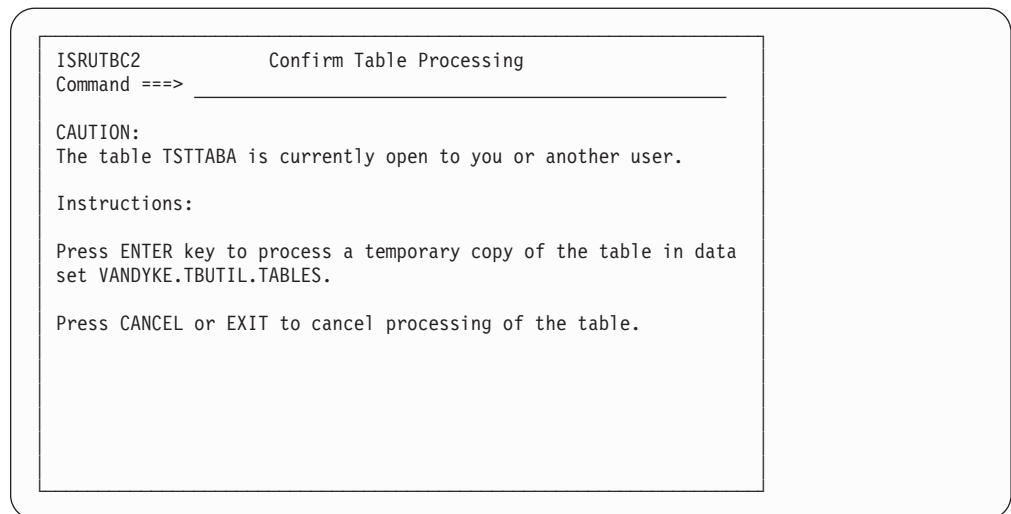

Figure 158. Panel displayed when the selected table is currently open but not in SHARE mode

The panel shown in Figure 158 is displayed when the selected table from the table data set (TSTTABA) is currently open but not in SHARE mode.

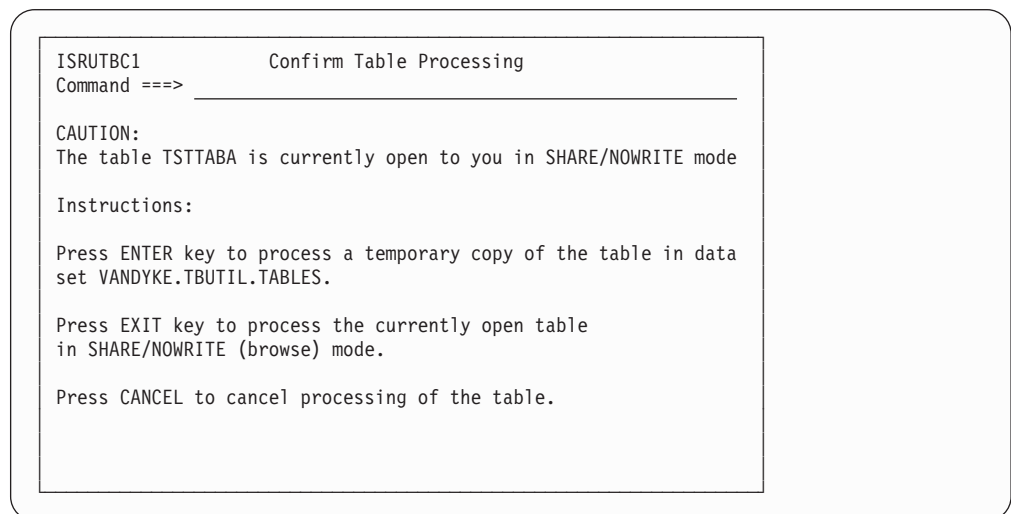

Figure 159. Panel displayed when the selected table is currently open in SHARE mode for NOWRITE

The panel shown in Figure 159 (ISRUTBC1) is displayed when the selected table (TSTTABA) from the table data set is currently open in SHARE mode for NOWRITE (not for update) and you either:

- Did not select the Open table in SHARE mode option on the entry or options panel, or
- Requested to edit (WRITE) the table

ISPF table utility (option 3.16)

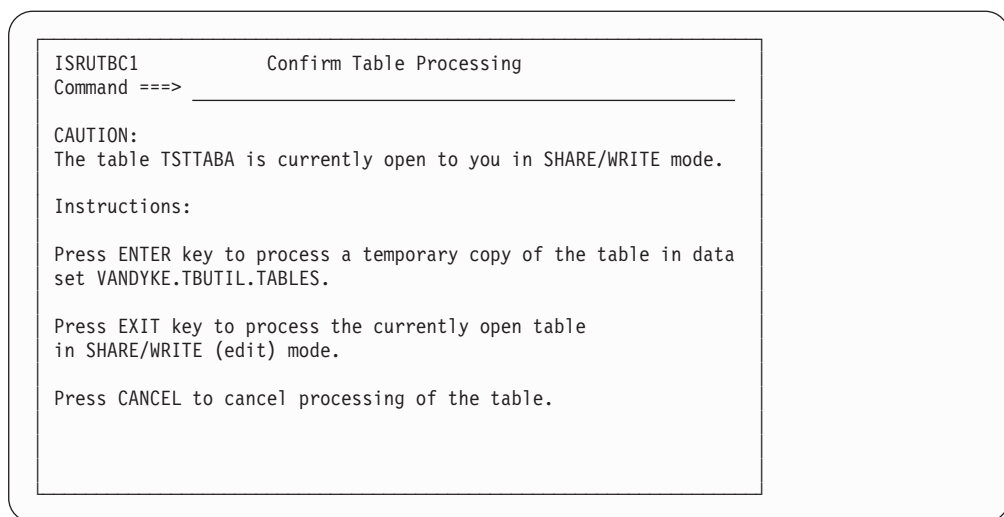

Figure 160. Panel displayed when the selected table is currently open in SHARE mode for WRITE

The panel shown in Figure 160 (ISRUTBC1) is displayed when the selected table (ISRPLIST) is currently open in SHARE mode for WRITE (for update) and you either:

- Did not select the Open table in SHARE mode option on the entry or options panel, or
- Requested to browse (NOWRITE) the table

If you press Enter, the table utility:

- Creates a temporary partitioned data set.
- Copies the table from the table data set you specified. into a member in the temporary data set using a generated member name.
- Opens the table using the generated name.
- Displays the table data.

If you press the Exit key (usually PF3) on panel ISRUTBC1, the table utility:

- Displays the data for the currently open table. If this table was originally opened for WRITE, the data is displayed for edit, otherwise it is displayed for browse.

If you press Cancel (or Exit on panel ISRUTBC2):

- The table is not processed and you are returned to the entry or table selection panel.

If you edit a temporary copy of an open table, this panel is displayed when you exit the edit display:

```

ISRUTBPB                Save Temporary Table
Command ==>>>

Specify the names of the data set and member where the temporary table
will be saved.

Partitioned Data Set Name and Member
  Name . . . . . 'VANDYKE.TBUTIL.TABLES'
  Member . . . . . ISRPLIST

Enter "/" to select option
_ Replace existing member

Instructions:

Press ENTER key to save the temporary table in the specified data set
and member.

Press EXIT or CANCEL to exit without saving the temporary table.

```

This panel allows you to save the updated table in a specified data set and member. The panel initially shows the table data set and table (member) you requested to edit. The "Replace existing member" option allows you to replace an existing member with the data from the table you have edited. If you press Enter, the table utility writes the table data to the specified data set and member. If you press Exit or Cancel, the data from the temporary table is not saved.

z/OS UNIX directory list utility (option 3.17)

The z/OS UNIX Directory List Utility (option 3.17) supports processing of directories and files in a z/OS UNIX directory structure. When you select this option, the z/OS UNIX Directory List Utility panel (ISRUULP) is displayed.

The layout and options of the Directory List Utility are similar to those in the Data Set List Utility (ISPF option 3.4). You can either display the directory list under the specified path name for further processing, or print the directory list to the ISPF list data set.

z/OS UNIX directory list utility (option 3.17)

```
Menu Utilities Options Help
-----
z/OS UNIX Directory List Utility
Option ==> _____
blank Display directory list      P Print directory list
Pathname . . . /var _____ +

Enter "/" to select option
/ Confirm File Delete
/ Confirm Non-empty Directory Delete

When the directory list is displayed, enter either:
"/" on the directory list line command field for the command prompt pop-up,
an ISPF line command, the name of a TSO command, CLIST, or REXX exec, or
"=" to execute the previous command.

Time zone EST5EDT is used to calculate the displayed date and time values.

F9=Swap   F10=Actions  F12=Cancel
```

Figure 161. z/OS UNIX Directory List Utility panel (ISRUULP)

Note: When the z/OS UNIX Directory List Utility panel is first displayed, a message is displayed showing the time zone that is used to calculate the date and time values displayed in the directory list. The time zone value is obtained from the z/OS UNIX TZ environment variable. If a value for the TZ environment value is not found in the system-wide /etc/profile file or the user's .profile file, the utility calculates displayed date and time values using the operating system GMT offset.

z/OS UNIX Directory List Utility panel action bar

The Data Set List Utility Panel action bar choices function as follows:

Menu For more information, see the details about the Menu Action Bar Choice in the ISPF User Interface topic in the *z/OS ISPF User's Guide Vol I*.

Utilities

For more information, see the details about the Utilities Action Bar Choice in the ISPF User Interface topic in the *z/OS ISPF User's Guide Vol I*.

Options

The Options pull-down offers these choices:

- 1 Directory List Options
Options that control the behavior of the directory list display.
- 2 Directory List Column Arrangement
Settings that alter the order and size of the column fields that are displayed in the directory list.
- 3 Directory List Default Line Commands
Settings that define the default line commands for the different z/OS UNIX file types.
- 4 Enable superuser mode(SU)
Select this option to switch to superuser mode.

Help The Help pull-down provides general information about z/OS UNIX Directory List Utility topics as well as information about displaying and printing a z/OS UNIX Directory List.

z/OS UNIX Directory List Utility panel fields

The z/OS UNIX Directory List Utility panel contains these fields:

Pathname

This is a scrollable field where you enter the path name of the directory you want to list or print. If you leave this field blank, your home directory is used. If the field is blank and you do not have a home directory, you are prompted to enter a path name.

You can use these special characters at the beginning of the Pathname field to represent the path name for a particular directory:

- ~ (Tilde) The path name for your home directory.
- .
- .. (Double period) The path name of the parent directory of your current working directory.

Note: Within the z/OS UNIX Directory List Utility, you can also use these special characters in any field where a z/OS UNIX file path name can be entered.

Confirm File Delete

This option controls the display of the Confirm Delete panel. This panel is displayed when deleting files or empty directories from the directory list display using the D line command. If this option is selected, the Confirm Delete panel is displayed. If this option is not selected, the panel is not displayed and the file or empty directory is deleted without any additional user interaction.

Confirm Non-empty Directory Delete

This option controls the display of the Confirm Non-empty Directory Delete panel. This panel is displayed when using the directory list D line command to delete a directory that contains files and subdirectories. If this option is selected, the Confirm Non-empty Directory Delete panel is displayed. If this option is not selected, the panel is not displayed and the directory (including all contained files and subdirectories) is deleted without any additional user interaction.

z/OS UNIX Directory List Utility panel options

See:

- “Blank—display directory list”
- “P—print directory list” on page 279

Blank—display directory list

To display a directory list for the specified path, leave the Option line blank and press Enter. If you leave the Pathname field blank, your home directory will be used.

You can also specify the options Confirm File Delete and Confirm Non-empty Directory Delete to control the behavior of the D (delete file) line command in the directory list.

z/OS UNIX directory list utility (option 3.17)

```

Menu Utilities View Options Help
-----
z/OS UNIX Directory List          Row 1 to 13 of 25
Command ==>                      Scroll ==> PAGE
Pathname . : /SYSTEM/etc

Command  Filename      Message      Type Permission Audit  Ext  Fmat
-----
.        .                Dir  rwxr-xr-x  fff---
..       ..               Dir  rwxr-xr-x  fff---
.nfsc    .nfsc            File rw-r--r-- fff--- --s- ----
ant.conf ant.conf        File rwxrwxrwx fff--- --s- ----
bpa      bpa              Dir  rwxr-xr-x  fff---
cmx      cmx              Dir  rwxr-xr-x  fff---
dce      dce              Dir  rwxr-xr-x  fff---
dfs      dfs              Dir  rwxr-xr-x  fff---
inetd.conf inetd.conf      File rwxrwxrwx fff--- --s- ----
inetd.pid inetd.pid       File rw-r--r-- fff--- --s- ----
ioepdcf ioepdcf        Syml rwxrwxrwx  fff---
ldap     ldap            Dir  rwxr-xr-x  fff---
licgmt   licgmt         Dir  rwxr-xr-x  fff---
log      log            File rw-rw---- fff--- --s- ----
pkiserv  pkiserv        Dir  rwxr-xr-x  fff---
profile  profile        File rwxr-xr-x  fff--- --s- ----
security security       Dir  rwxr-xr-x  fff---
F1=Help  F2=Split  F3=Exit  F4=Expand  F5=Rfind  F7=Up    F8=Down
F9=Swap  F10=Left  F11=Right F12=Cancel

```

Figure 162. z/OS UNIX Directory List panel (ISRUUDL0)

The information for each entry in the directory is displayed in column fields across the screen. The number of columns displayed depends on the available screen width. Figure 162 shows the initial directory list display on a terminal with a screen width of 80 and a screen depth of 28.

The RIGHT primary command can be used to scroll the displayed column fields to the right. Figure 163 on page 273 shows the directory list display when the RIGHT command is issued on the previous display:

Menu Utilities View Options Help						
z/OS UNIX Directory List					Row 1 to 13 of 25	
Command ==>					Scroll ==> PAGE	
Pathname . : /SYSTEM/etc						
Command	Filename	Message	Owner	Group	Links	Size
_____	.		IBMUSER	OMVSGRP	14	8192
_____	..		IBMUSER	OMVSGRP	6	8192
_____	.nfsc		IBMUSER	OMVSGRP	1	0
_____	ant.conf		IBMUSER	OMVSGRP	1	29
_____	bpa		IBMUSER	OMVSGRP	2	8192
_____	cmx		IBMUSER	OMVSGRP	2	8192
_____	dce		IBMUSER	OMVSGRP	9	8192
_____	dfs		IBMUSER	OMVSGRP	8	8192
_____	inetd.conf		IBMUSER	OMVSGRP	1	1215
_____	inetd.pid		IBMUSER	OMVSGRP	1	10
_____	ioepdcf		IBMUSER	OMVSGRP	1	22
_____	ldap		IBMUSER	OMVSGRP	2	8192
_____	licmgmt		IBMUSER	OMVSGRP	6	8192
_____	log		IBMUSER	OMVSGRP	1	0
_____	pkiserv		IBMUSER	OMVSGRP	2	8192
_____	profile		IBMUSER	OMVSGRP	1	10665
_____	security		IBMUSER	OMVSGRP	2	8192
F1=Help F2=Split F3=Exit F4=Expand F5=Rfind F7=Up F8=Down						
F9=Swap F10=Left F11=Right F12=Cancel						

Figure 163. z/OS UNIX Directory List—scrolling right

Note: These two screens assume that the default column arrangement settings are used. You can change the width of column fields and the order in which they are displayed, and remove selected columns from the directory list display. See “z/OS UNIX Directory List Column Arrangement panel” on page 315.

z/OS UNIX Directory List panel action bar: The z/OS UNIX Directory List panel action bar choices function as follows:

Menu For more information, see the details about the Menu Action Bar Choice in the ISPF User Interface topic in the *z/OS ISPF User's Guide Vol I*.

Utilities

For more information, see the details about the Utilities Action Bar Choice in the ISPF User Interface topic in the *z/OS ISPF User's Guide Vol I*.

View The View pull-down offers this choice: **1. Sort**

You can sort the list by any of these fields:

1. Filename
2. Message
3. File Type
4. Permissions
5. Permissions - Octal
6. Owner
7. Audit
8. Extended Attributes
9. Format
10. Group
11. Links
12. Size

z/OS UNIX directory list utility (option 3.17)

13. Changed Date/Time
14. Modified Date/Time
15. Accessed Date/Time
16. Created Date/Time

You can also specify the sort sequence (ascending or descending) or accept the default sequence for the associated sort field. By default, character fields are sorted alphabetically and numeric fields are sorted in descending order.

Options

The Options pull-down offers these choices:

- 1 Directory List Options
Options that control the behaviour of the directory list display.
- 2 Directory List Column Arrangement
Settings that alter the order and size of the directory list column fields and allow you to remove columns from the display.
- 3 Directory List Default Line Commands
Settings that define the default line commands for the different z/OS UNIX file types.
- 4 Enable superuser mode(SU)
Select this option to switch to superuser mode.
- 5 Refresh List
Refresh the display of the directory list.
- 6 Save List
Save the directory list to a file.
- 7 Reset
Reset the directory list.

Help The Help pull-down provides general information about z/OS UNIX Directory List Utility topics, including the format of the directory list and the available line commands and primary commands.

z/OS UNIX Directory List panel fields: The fields listed here can appear on the directory list panel. Which fields are displayed depends on the column arrangements settings and whether the display has been scrolled left or right.

Command

Field used to enter a line command, z/OS UNIX command, TSO command, CLIST, or REXX exec against a directory list entry.

Filename

The name of the file or subdirectory.

Message

This field is initially blank. After you run one of the built-in line commands on a file or subdirectory, a message is displayed showing the last function used on that file or subdirectory:

LineCommand
Message

AA	Modified
B	Browsed
CI	Replaced
CO	Copied
E	Edited
D	Deleted
FS	Information
I	Information
L	Listed
MF	Modified
MG	Modified
MM	Modified
MO	Modified
MX	Modified
N	Created
R	Renamed
UA	Modified
X	(Depends on whether a z/OS UNIX command or TSO command is executed)

If you enter a TSO command, CLIST, or REXX exec on the Command line, a default message appears in the Message field. The message is in this format:

```
XXXXXXXX RC=#
```

where:

```
XXXXXXXX
```

is the command entered

is the return code from the command

If you enter a z/OS UNIX command, the completion status is indicated by one of these messages being displayed in the Message field:

Ended xxx

Command has ended with a return code of xxx

Terminated xxx

Command has terminated due to signal xxx

Stopped xxx

Command has stopped due to signal xxx

Timed out

The elapsed running time of the command exceeded the specified time limit. ISPF sent a SIGKILL signal to terminate the process.

Type The directory entry type. The possible values are:

Dir Directory

File Regular file

z/OS UNIX directory list utility (option 3.17)

- Char** Character special file
- FIFO** FIFO (first-in-first-out) special file
- Syml** Symbolic link
- Extl** External symbolic link

Perm The file or subdirectory permissions, in octal format. The permissions are displayed as three octal (range 0-7) digits. The first digit defines the access permission for the file owner. The second digit defines the access permission for any member of the file's group. The third digit defines the access permission for anyone else. Table 16 shows the values and associated permissions for the octal digits:

Table 16. Octal permission values

Value	Permissions
0	None
1	Search (or execute)
2	Write
3	Write and search (or execute)
4	Read
5	Read and search (or execute)
6	Read and write
7	Read, write and search (or execute)

If there are extended access control list (ACL) entries defined for the file or subdirectory, the character + is displayed after the octal value.

Permissions

The file or subdirectory permissions, in symbolic format. There are three groups of three characters. The first group describes owner permissions; the second describes group permissions; and the third describes other (or "world") permissions. The characters that may appear in each group are:

- r** Permission to read the file
- w** Permission to write to the file
- x** Permission to execute the file

These characters can appear in the execute (third) position of each group:

- s** If in owner permissions group, the set-user-ID bit is on; if in group permissions section, the set-group-ID bit is on.
- S** Same as s except the execute bit is off.
- t** The sticky bit is on.
- T** Same as t except the execute bit is off.

Note: You can specify whether permissions are to be displayed in octal or symbolic format on the z/OS UNIX Directory List Options panel.

Audit Two groups of three characters describing the audit bit settings. The first three characters describe the user-requested audit information. The last three characters describe the auditor-requested audit information. Each group of three characters shows the read, write, and execute (search) audit options. The possible values are:

- s** Audit successful access attempts
- f** Audit failed access attempts
- a** Audit all access attempts
- No audit

Ext A group of four characters describing the extended attributes for a regular file. The possible values are:

- a** Program runs APF-authorized if linked AC=1
- p** Program is considered program-controlled
- s** Program is enabled to run in a shared address space
- l** Program is loaded from the shared library region
- Attribute not set

Fmat File format for regular files. The possible values are:

- bin**
Binary data
- n1** New line
- cr** Carriage return
- lf** Line feed
- crlf**
Carriage return followed by line feed
- lfcr**
Line feed followed by carriage return
- crnl**
Carriage return followed by new line

Owner

The user ID of the owner of the file or subdirectory.

Group The group name of the owner of the file or subdirectory.

Links For a file, the number of hard links to the file. For a subdirectory, the number of subdirectories it contains.

Size The file size, in bytes.

Modified

The date and time the file was last changed.

Changed

The date and time the status of the file was last changed.

Accessed

The date and time the data in the file was last accessed.

Created

The date and time the file was created.

Actions you can take from the Directory List panel: These topics describe actions you can take from the Directory List panel:

- "Line commands"
- "z/OS UNIX commands, TSO commands, CLISTs, and REXX EXECs"
- "Using the path name substitution character" on page 279

Line commands: Line commands can be entered in the Command field to the left of the directory list entries.

z/OS UNIX commands, TSO commands, CLISTs, and REXX EXECs: Besides the ISPF-supplied line commands, you can also enter z/OS UNIX Commands, TSO commands, CLISTs, and REXX EXECs that use a path name as an operand. The line command field is a scrollable field with a maximum length of 255 characters and a display length of 8 characters. If the command you want to enter requires more space than is available in the display field, use the EXPAND function key (F4) to display the entire 255-character line command input field in a pop-up window.

z/OS UNIX directory list utility (option 3.17)

The line command prefix characters > and < are used to identify a command to be run in z/OS UNIX. ISPF uses the **spawn** service (BPX1SPN) to create a new process and execute the command. The > prefix character requests that the command be run by the z/OS UNIX login shell. The < prefix character requests that the command be run directly.

Figure 164 shows an example of using the c89 shell command to compile, link-edit, and assemble the C program contained in the file /u/myhome/hello.c. The > character before the command name indicates that it will be run in a login shell environment:

```
z/OS UNIX Directory List                               Row 1 to 6 of 6
Command ==>> _____ Scroll ==>> CSR
Pathname . : /u/myhome
Command  Filename      Message          Type Permission Audit  Ext  Fmat
-----
_____ .                Dir  rwxrwxrwx  fff--
_____ ..               Dir  rwxrwxrwx  fff--
_____ bin               Dir  rwxrwxrwx  fff--
>c89    hello.c           File  rwxrwxrwx  fff-- --s- ----
_____ prog1            File  rwxrwxrwx  fff-- --s- ----
_____ test1            File  rwxrwxrwx  fff-- --s- ----
***** Bottom of data *****
:
:
```

Figure 164. Example: specifying a z/OS UNIX command to run on a selected file

Figure 165 shows an example of running the program /u/myhome/hello.c directly in z/OS UNIX. The < character indicates that the selected file is the name of a command that is to be run:

```
z/OS UNIX Directory List                               Row 1 to 6 of 6
Command ==>> _____ Scroll ==>> CSR
Pathname . : /u/myhome/bin
Command  Filename      Message          Type Permission Audit  Ext  Fmat
-----
_____ .                Dir  rwxrwxrwx  fff--
_____ ..               Dir  rwxrwxrwx  fff--
_____ bin               Dir  rwxrwxrwx  fff--
<       hello.c           File  rwxrwxrwx  fff-- --s- ----
_____ prog1            File  rwxrwxrwx  fff-- --s- ----
_____ test1            File  rwxrwxrwx  fff-- --s- ----
***** Bottom of data *****
:
:
```

Figure 165. Example: running the selected file directly

A line command that is not recognized as a z/OS UNIX Directory List line command, or is not prefixed with < or >, is assumed to be a TSO command, CLIST, or REXX EXEC. These commands are passed to TSO for execution using the ISPF SELECT CMD service. Variable names that start with an ampersand (&) are evaluated by ISPF. If you want the underlying command processor to see the ampersand you must specify two consecutive ampersands (&&).

Figure 166 on page 279 shows an example of running a REXX EXEC called LISTDATA against the file prog1 in directory /u/myhome. This is the same as entering this command on the Command line:

```
TSO LISTDATA '/u/myhome/prog1'
```

```

z/OS UNIX Directory List                               Row 1 to 6 of 6
Command ==> _____ Scroll ==> CSR
Pathname . : /u/myhome

Command  Filename      Message          Type Permission Audit  Ext  Fmat
-----
_____ .                Dir  rwxrwxrwx  fff---
_____ ..               Dir  rwxrwxrwx  fff---
_____ bin              Dir  rwxrwxrwx  fff---
_____ hello.c          File rwxrwxrwx  fff--- --s- ----
listdata prog1         File rwxrwxrwx  fff--- --s- ----
_____ test1          File rwxrwxrwx  fff--- --s- ----
***** Bottom of data *****
:

```

Figure 166. Example: specifying a REXX exec to run on a selected file

Note: If the TSO command, CLIST, or REXX exec issues a return code greater than or equal to 8, processing stops and an error message is displayed.

Using the path name substitution character: If a command, CLIST, or REXX exec requires the file or subdirectory path name in a position other than the first operand or if other operands are needed, you can use the path name substitution character to represent the path name. If no operands are specified after the command, ISPF uses the path name of the file or subdirectory that is being acted on as the first operand of the command.

Note: For TSO commands, CLISTs, and REXX EXECs, the path name is enclosed in quotes.

The ISPF-defined default for the path name substitution character is the exclamation point (!) character. You can change the value of this character using the z/OS UNIX Directory List Options panel.

For example, if you specify: CLIST1 FILE(!) DEBUG in the line command field for file test_data in directory u/myhome the effect will be the same as if you had entered this primary command:

```
TSO CLIST1 FILE('/u/myhome/test_data') DEBUG
```

P—print directory list

Use option P to print a directory list. You must:

1. Enter the path name for the directory you want to list in the Pathname field. If you leave this field blank, the path name for your home directory will be used.
2. Press Enter to print the directory list. The directory list is stored in the ISPF list data set.

Note: The format of the printed directory list is not affected by any changes you make using the z/OS UNIX Directory List Column Arrangement panel.

z/OS UNIX directory list utility line commands

After you display a directory list by leaving the Option field blank, you can enter a line command to the left of a directory entry. You can also enter TSO commands, CLIST names, or REXX exec names. The path name substitution character can be

z/OS UNIX directory list utility (option 3.17)

used with TSO commands, CLISTs, and REXX EXECs to represent the quoted path name for a file or subdirectory. For more information about using this symbol, see "Using the path name substitution character" on page 279.

The line command field is a scrollable field with a maximum length of 255 characters and a display length of 8 characters. If the command you want to enter requires more space than is available in the display field, use the EXPAND function key (F4) to display the entire 255-character line command input field in a pop-up window.

If you enter a slash (/) in the Command field, the Directory List Actions pop-up window is displayed. This window allows you to select the line command you wish to invoke.

You can also enter line commands in block command format to execute the same line command for several files at once. You mark the block by typing a "//" at the beginning of a block of rows and another "//" at the end of the block of rows. You must type the line command either immediately after the // on the first row of the block, or immediately after the // on the last row of the block. You can enter several blocks of commands at the same time, but you cannot nest them. Single line commands are not allowed within a block command. You can execute all line commands, including z/OS UNIX commands, TSO commands, Clists and REXX execs as block commands.

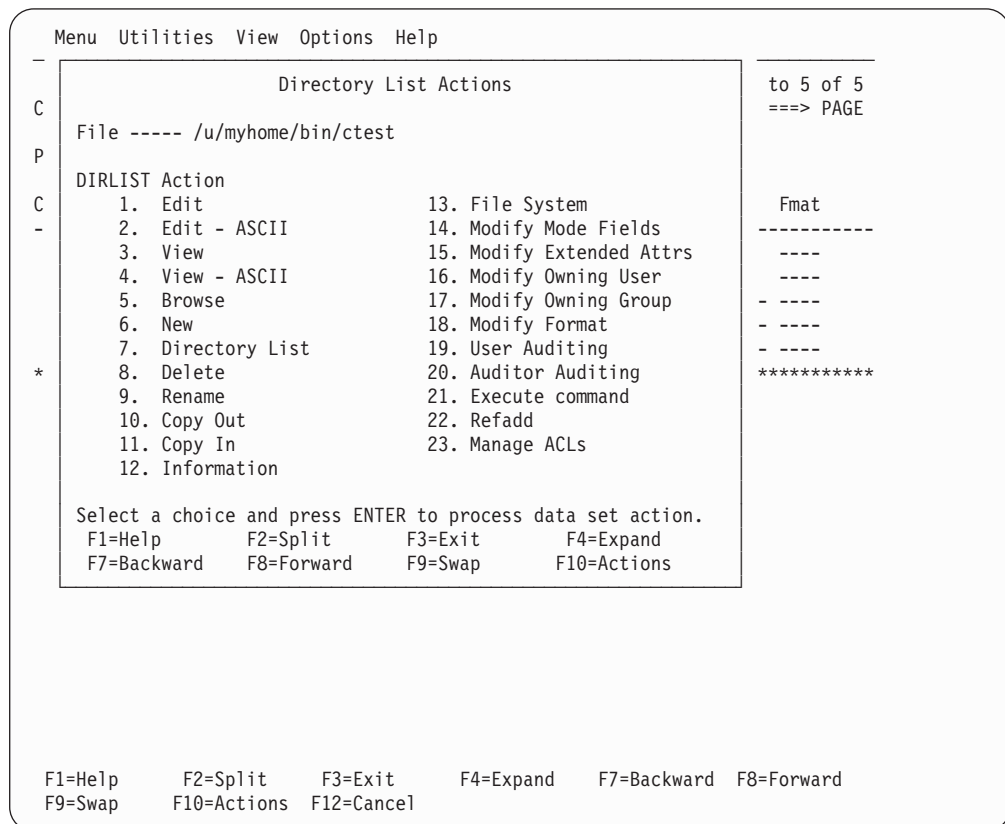

Figure 167. z/OS UNIX Directory List Actions pop-up window

AA—auditor auditing

The AA (auditor auditing) line command can be entered against any directory entry. This line command causes the Modify z/OS UNIX File Auditor Audit

Options panel to be displayed.

```

Menu Utilities View Options Help
-----
Modify z/OS UNIX File Auditor Audit Options
-----
- Command ==>> _____
- Pathname . . : /u/myhome/prog1
- Type . . . . : File
-
- Read 1 1. None    Write 1 1. None    Execute 1 1. None
-        2. Failure 2. Failure 2. Failure
-        3. Success 3. Success 3. Success
-        4. Both    4. Both    4. Both
-
-
-
- F1=Help    F2=Split    F3=Exit    F4=Expand    F7=Backward
- F8=Forward F9=Swap     F10=Actions F12=Cancel
-
F1=Help    F2=Split    F3=Exit    F4=Expand    F7=Backward F8=Forward
F9=Swap    F10=Actions F12=Cancel

```

Figure 168. Modify z/OS UNIX File Auditor Audit Options panel (ISRUULAA)

The Pathname field displays the path name of the selected file. The Type field display the file type for the selected file.

The auditor auditing options for the file can be changed by a user defined with AUDITOR authority in the security system. These options allow you to define the access attempts that will be audited by the security system. You can specify auditing to occur for read, write, and search or execute attempts on the file or directory.

The panel displays fields for specifying the Read, Write and Execute (or search) audit settings. For each of these fields you enter one of the listed numbers corresponding to one of these results for the access attempt:

None No audit record is to be written for this type of access.

Failure

Write an audit record if this type of access fails.

Success

Write an audit record if this type of access is successful.

Both Write an audit record for both failed and successful access attempts.

B—browse regular file

The B (browse) line command can be entered against a regular file or directory. The ISPF browse function is invoked, allowing you to view the data in the file.

If you enter the B line command beside a directory a directory list is displayed allowing you to select a regular file to browse.

A numeric record length can also be specified as an option with the B line command for a regular file. This option allows you to browse fixed-length record files containing text or binary data without new line delimiters.

C or CO—copy data out

The C or CO (copy out) line command can be entered against a regular file or directory.

z/OS UNIX directory list utility (option 3.17)

Note: In the panel displayed by the CO line command, you can specify a "+" (plus) character as the first character of a path name to represent the path name of the directory currently listed.

Copying from a regular file: When the C or CO line command is entered against a regular file, the Copy From z/OS UNIX File panel is displayed.

```
Copy From z/OS UNIX File
Command ==> _____
From z/OS UNIX file:
  Name . . . : /u/mburns/cargs1.c
To z/OS UNIX file, data set, or member:
  Name . . . . _____ +
  Permissions 700 (Octal)
Options
  / Confirm copy to existing target
  - Update permissions for existing target file
  - Binary copy
  - Convert
Conversion Table _____

F1=Help   F2=Split  F3=Exit   F4=Expand F5=Rfind  F7=Up
F8=Down   F9=Swap   F10=Left F11=Right F12=Cancel
```

Figure 169. Copy From z/OS UNIX File panel (ISRUULCF)

This panel allows you to copy the data in a regular file to another z/OS UNIX file, a sequential data set, or a member of a partitioned data set.

Note: When copying to a sequential data set or member of a partitioned data set, ISPF invokes the z/OS UNIX OGET command to perform the copy operation.

The panel displays the path name of the file being copied.

These mandatory input fields are displayed on this panel:

Name The destination where the data from the file will be copied. Any of these can be specified:

- The path name of a z/OS UNIX file.
- The name of a sequential data set.
- The names of an existing partitioned data set and member.

Permissions

When copying to a z/OS UNIX file, defines the permissions for that file. Enter as three octal (range 0-7) digits. The first digit defines the access permission for the file owner. The second digit defines the access permission for any member of the file's group. The third digit defines the access permission for anyone else. See Table 16 on page 276.

These optional input fields are available on this panel:

Confirm copy to existing target

When this option is selected and the target z/OS UNIX file, data set, or member exists, the Confirm Copy panel displays a warning that the data in the target will be overwritten if the copy proceeds.

In this situation, proceeding with the copy will cause the data in the target to be overwritten. Since this is an irrevocable process which may cause loss of valuable data, ISPF requires you to confirm you really want the copy to proceed. If you have made a mistake, the copy operation can be canceled using the CANCEL or EXIT commands.

Update permissions for existing target file

If this option is selected and the target of the copy is an existing z/OS UNIX file, the value specified in the Permissions field will be used to update the permissions for this file.

Binary copy

When this option is selected it indicates the file being copied contains binary data. This causes the copy to take place without any consideration for newline characters or the special characteristics of DBCS data. If this option is not selected the file is assumed to contain TEXT data.

Note: This option is ignored when copying to another z/OS UNIX file.

Convert

This option specifies whether data conversion is required during the copy operation. Typically, conversion is only required when the data contains square brackets. If no value is entered in the Conversion Table field, the data being copied is converted using the default conversion table (BPXFX000) in the standard library concatenation. By default, this would cause a conversion between code pages IBM-037 and IBM-1047. Otherwise the value in the Conversion Table field identifies a conversion table to be used for the copy operation.

Note: This option is ignored when copying to another z/OS UNIX file.

Conversion Table

These types of values can be specified in this field:

- *data_set_name(member_name)*

The partitioned data set and member containing the character conversion table.

- *data_set_name*

The partitioned data set that has the member BPXFX000 containing the character conversion table.

- *(member_name)*

The member containing the character conversion table. It is assumed to be in a data set in the standard library concatenation. (The default data set is SYS1.LINKLIB.)

Note: This field is ignored if the Convert option is not selected or if copying to another z/OS UNIX file.

For further information on the character conversion table refer to the description of the OGET command in the *z/OS UNIX System Services Command Reference*.

Copying from a directory: When the C or CO line command is entered against a directory, the Copy From z/OS UNIX Directory panel is displayed.

z/OS UNIX directory list utility (option 3.17)

```
Copy From z/OS UNIX Directory
Command ==> _____
From z/OS UNIX directory:
  Name . . . : /u/mburns/jcldir
To partitioned data set:
  Name . . . . _____
Options
- Replace like-named members
- Selection list...
7 Include lowercase names
7 Strip suffix _____ (Suffix to strip)
- Binary copy
- Convert
-
Conversion Table _____

F1=Help      F2=Split    F3=Exit     F4=Expand   F7=Backward
F8=Forward   F9=Swap     F10=Actions F12=Cancel
```

Figure 170. Copy From z/OS UNIX Directory panel (ISRUULCD)

This panel allows you to copy the data from regular files in a directory to members in a partitioned data set.

Note: When copying to a member of a partitioned data set, ISPF invokes the z/OS UNIX OGET command to perform the copy operation.

For a file to be selected for copying, it must have a file name that conforms to the naming conventions for a partitioned data set member. This panel also provides options that allow you to further control the files selected for copying.

The panel displays the path name of the directory being copied. These mandatory input fields are displayed on this panel:

Name The name of an existing partitioned data set where the regular files in the directory will be copied. The files are copied into members in the partitioned data set.

These optional input fields are available on this panel:

Replace like-named members

When this option is selected, if the file into which the data from a selected member is to be copied already exists in the directory, the existing file will be overwritten with the data from the selected member. If this option is not selected, the member will not be copied.

Selection list

If this option is selected, the z/OS UNIX Directory Copy Selection List panel is displayed. This panel displays a list of the regular files that are eligible to be copied to the partitioned data set. The list contains these fields:

S An input field where you can enter S to indicate the associated regular file is to be copied to the partitioned data set.

Filename

The name of a regular file that can be copied to the partitioned data set. The name conforms to the rules for a member name and fits the selection criteria specified on the Copy From z/OS UNIX Directory panel.

Member

The name to be used for the member into which the data from the associated regular file will be copied. Each member name is generated from the name of the source file. You can change a generated member name to something other than the name assigned by ISPF. For example, if ISPF generates the same member name for two files, you can change one of the member names to make them both unique.

Message

This field displays a message indicating the result of copying the regular file to the member. The possible values displayed are:

***COPIED**

The data from the regular file was successfully copied to a new member in the partitioned data set.

***REPL** The data from the regular file was copied to an existing member in the partitioned data set. The data in the member was overwritten. This can only occur when the Replace like-named members option is selected on the Copy From z/OS UNIX Directory panel.

***NO-REPL**

The data from the regular file was not copied to the partitioned data set member because the member already existed and the Replace like-named members option was not selected on the Copy From z/OS UNIX Directory panel.

***FAILED RC=xx**

The OGET command invoked to copy the data from the file to the member failed with return code *xx*. The data was not copied.

When you press Enter on this panel, the selected files will be copied to the partitioned data set. The Message field indicates the result of the copy operation for each file.

Include lowercase names

When this option is selected the file names for the regular files will be converted to uppercase before being checked for a valid member name. If this option is not selected, regular files whose file name contains lowercase characters will not be considered for copying to the partitioned data set.

Strip suffix

When this option is selected suffixes will be stripped from the file name at the first period (.) before being checked for a valid member name. The accompanying input field allows you to specify a particular suffix to be stripped (regular files with other suffixes will not be considered for copying). If this option is not selected, any regular files whose file name includes suffixes will not be copied to the partitioned data set.

Selecting this option can result in ISPF attempting to copy different files into the same member. For example, if the **Strip suffix** option is selected and the directory being copied contains these files:

- pgm1.exe
- pgm1.o
- pgm1.C

z/OS UNIX directory list utility (option 3.17)

the data for each of these files is written to member PGM1. If the **Replace like-named members** option is also selected, member PGM1 will contain the data from file pgm1.C. If the **Replace like-named members** option is not selected, member PGM1 will contain the data from file pgm1.exe.

Binary copy

When this option is selected it indicates the file being copied contains binary data. This causes the copy to take place without any consideration for newline characters or the special characteristics of DBCS data. If this option is not selected the file is assumed to contain TEXT data.

Convert

This option specifies whether data conversion is required during the copy operation. Typically, conversion is only required when the data contains square brackets. If no value is entered in the Conversion Table field, the data being copied is converted using the default conversion table (BPXFX000) in the standard library concatenation. By default, this would cause a conversion between code pages IBM-037 and IBM-1047. Otherwise the value in the Conversion Table field identifies a conversion table to be used for the copy operation.

Conversion Table

These types of values can be specified in this field:

- *data_set_name(member_name)*
The partitioned data set and member containing the character conversion table.
- *data_set_name*
The partitioned data set that has the member BPXFX000 containing the character conversion table.
- *(member_name)*
The member containing the character conversion table. It is assumed to be in a data set in the standard library concatenation. (The default data set is SYS1.LINKLIB.)

Note: This field is ignored if the Convert option is not selected or if copying to another z/OS UNIX file.

For further information on the character conversion table refer to the description of the OGET command in the *z/OS UNIX System Services Command Reference*.

CI—copy data in

The CI (copy in) line command can be entered against a regular file or directory.

Note: In the panel displayed by the CI line command, you can specify a "+" (plus) character as the first character of a path name to represent the path name of the directory currently listed.

Copying into a regular file: When the CI line command is entered against a regular file, the Replace z/OS UNIX File panel is displayed.

```

                                Replace z/OS UNIX File
Command ==> _____

Into z/OS UNIX file:
  Name . . . : /u/mburns/abcde

From z/OS UNIX file, data set, or member:
  Name . . . . _____ +

Options
  - Binary copy
  - Convert

Conversion Table _____

F1=Help      F2=Split    F3=Exit     F4=Expand   F7=Backward
F8=Forward   F9=Swap     F10=Actions F12=Cancel

```

Figure 171. Replace z/OS UNIX File panel (ISRUULRF)

This panel allows you to copy into a regular file data from another z/OS UNIX file, a sequential data set, or a member of a partitioned data set.

Note:

1. When copying from a sequential data set or member of a partitioned data set, ISPF invokes the z/OS UNIX OPUT command to perform the copy operation.
2. this operation will cause existing data in the regular file to be overwritten.

The panel displays the path name of the file into which the data will be copied. These mandatory input fields are displayed on this panel:

Name The source of the data to be copied into the file. Any of these can be specified:

- The path name of a z/OS UNIX file
- The name of a sequential data set
- The names of an existing partitioned data set and member

These optional input fields are available on this panel:

Binary copy

When this option is selected it indicates the data set/member being copied contains binary data. This causes the copy to take place without any consideration for newline characters or the special characteristics of DBCS data. If this option is not selected the data set/member is assumed to contain TEXT data.

Note: This option is ignored when copying to another z/OS UNIX file.

Convert

This option specifies whether data conversion is required during the copy operation. Typically, conversion is only required when the data contains square brackets. If no value is entered in the Conversion Table field, the data being copied is converted using the default conversion table (BPXFX000) in the standard library concatenation. By default, this would

z/OS UNIX directory list utility (option 3.17)

cause a conversion between code pages IBM-037 and IBM-1047. Otherwise the value in the Conversion Table field identifies a conversion table to be used for the copy operation.

Note: This option is ignored when copying to another z/OS UNIX file.

Conversion Table

These types of values can be specified in this field:

- *data_set_name(member_name)*

The partitioned data set and member containing the character conversion table.

- *data_set_name*

The partitioned data set that has the member BPXFX000 containing the character conversion table.

- *(member_name)*

The member containing the character conversion table. It is assumed to be in a data set in the standard library concatenation. (The default data set is SYS1.LINKLIB.)

Note: This field is ignored if the Convert option is not selected or if copying from another z/OS UNIX file.

For further information on the character conversion table refer to the description of the OPUT command in the *z/OS UNIX System Services Command Reference*.

Copying into a directory: When the CI line command is entered against a directory, the Copy Into z/OS UNIX Directory panel is displayed.

```
Copy Into z/OS UNIX Directory
Command ==> _____ More: +
Into z/OS UNIX directory:
  Name . . . : /u/mburns/abcdir1
From partitioned data set:
  Name . . . . EXEC
Permissions  777
Suffix . . . . _____
Options
- Replace like-named files
- Update permissions for replaced files
/ Selection list...
/ Convert to lowercase
- Binary copy
- Convert
Conversion Table
F1=Help      F2=Split    F3=Exit     F4=Expand   F7=Backward
F8=Forward   F9=Swap     F10=Actions F12=Cancel
```

Figure 172. Copy Into z/OS UNIX Directory panel (ISRUULRD)

This panel allows you to copy the data from members of a partitioned data set into regular files in a directory.

Note: ISPF invokes the z/OS UNIX OPUT command to perform the operation of copying data from a member of a partitioned data set into a regular file.

The panel displays the path name of the directory into which the members of the partitioned data set will be copied. These mandatory input fields are displayed on this panel:

Name The name of an existing partitioned data set containing the members that will be copied as regular files into the selected directory.

Permissions

Defines the permissions for new regular files created when copying a partitioned data set member in the directory. When the option "Update permissions for replaced files" is selected, it also defines new permissions applied to a file replaced during the copy operation. Enter as three octal (range 0-7) digits. The first digit defines the access permission for the file owner. The second digit defines the access permission for any member of the file's group. The third digit defines the access permission for anyone else. See Table 16 on page 276.

These optional input fields are available on this panel:

Suffix This field allows you to specify a value that will be added to the end of the member name to form the file name of the regular file that is created or updated during the copy operation. The member name and suffix are separated by a period (.). Any leading periods specified in the suffix are ignored.

Replace like-named files

When this option is selected, if the file into which the data from a selected member is to be copied already exists in the directory, the contents of the existing file will be overwritten with the data from the selected member. If this option is not selected, the copy of that member will not be performed.

Update permissions for replaced files

When this option is selected it causes existing files that are replaced by the copy operation to also have their permissions changed to the value specified in the Permissions field.

Selection List

If this option is selected, the Copy Into z/OS UNIX Directory - Selection List panel is displayed. This panel displays a list of the members in the partitioned data set that can be selected for copying into the directory. The list contains these fields:

S An input field where you can enter S to indicate the associated member is to be copied into the directory.

Member

The name of the partitioned data set member that can be copied into the directory.

Filename

The name to be used for the regular file into which the data from the associated member will be copied. This is an input field, allowing you to change the file name to something other than the name assigned by ISPF. The field is scrollable and is 1023 bytes long. Use the EXPAND function key (F4) to display the entire field in a pop-up window.

Message

This field displays a message indicating the result of copying the member to the regular file. The possible values displayed are:

z/OS UNIX directory list utility (option 3.17)

*COPIED

The data from the member was successfully copied to a new regular file in the directory.

*REPL The data from the member was copied to an existing regular file in the directory. The data in the file was overwritten. This can only occur when the Replace like-named files option is selected on the Copy Into z/OS UNIX Directory panel.

*NO-REPL

The data from the member was not copied to the file in the directory because the file already existed and the Replace like-named files option was not selected on the Copy Into z/OS UNIX Directory panel.

*FAILED RC=*xx*

The OPUT command invoked to copy the data from the member to the regular file failed with return code *xx*. The data was not copied.

When you press Enter on this panel, the selected members will be copied to the directory. The Message field indicates the result of the copy operation for each member.

Convert to lowercase

When this option is selected it causes the member name to be converted to lowercase before it is used to generate the file name for the target regular file.

Binary copy

When this option is selected it indicates the members being copied contains binary data. This causes the copy to take place without any consideration for newline characters or the special characteristics of DBCS data. If this option is not selected the members are assumed to contain TEXT data.

Convert

This option specifies whether data conversion is required during the copy operation. Typically, conversion is only required when the data contains square brackets. If no value is entered in the Conversion Table field, the data being copied is converted using the default conversion table (BPXFX000) in the standard library concatenation. By default, this would cause a conversion between code pages IBM-037 and IBM-1047. Otherwise the value in the Conversion Table field identifies a conversion table to be used for the copy operation.

Conversion Table

These types of values can be specified in this field:

- *data_set_name(member_name)*
The partitioned data set and member containing the character conversion table.
- *data_set_name*
The partitioned data set that has the member BPXFX000 containing the character conversion table.
- *(member_name)*

The member containing the character conversion table. It is assumed to be in a data set in the standard library concatenation. (The default data set is SYS1.LINKLIB.)

Note: This field is ignored if the Convert option is not selected.

For further information on the character conversion table refer to the description of the OPUT command in the *z/OS UNIX System Services Command Reference*.

D—delete a file

The D (delete file) line command can be entered against any directory entry. If entered against a file or an empty directory and the Confirm File Delete option is selected, the Confirm Delete panel is displayed. This panel allows the delete operation to be canceled if necessary using the CANCEL or EXIT commands. You can prevent this panel being displayed for subsequent delete operations by selecting the “Set file delete confirmation off” option.

If the deletion proceeds successfully, the file or directory is removed from the file system.

If the D line command is entered against a directory containing files and subdirectories and the Confirm Non-empty Directory Delete option is selected, the Confirm Non-empty Directory Delete panel is displayed. This panel allows the delete operation to be canceled if necessary using the CANCEL or EXIT commands. You can prevent this panel being displayed for subsequent delete operations by selecting the “Set non-empty directory delete confirmation off” option.

If the deletion proceeds successfully the directory, including all contained files and subdirectories, is removed from the file system.

E—edit regular file

The E (edit) line command can be entered against a regular file or directory. The ISPF editor is invoked, allowing you to change the data in the file.

If you enter the E line command beside a directory, a directory list is displayed allowing you to select a regular file to edit.

A numeric record length can also be specified as an option with the E line command for a regular file. This option allows you to set the record length when editing fixed-length text files. When specified, the file is processed as variable length but loaded into the editor as fixed-length records and saved as fixed-length records. This lets you convert a variable-length file to fixed length.

The Edit Entry panel can be displayed when the E line command is entered. This panel allows you specify items including the initial macro, profile name, panel name, format, mixed mode, and workstation editing. These values are stored in the profile and are used on subsequent edits. The **Bypass z/OS UNIX File Edit Options panel** option on the z/OS UNIX Directory List Options panel can be selected to stop this panel being displayed for subsequent file edit sessions.

EA—edit ASCII file

The EA (Edit - ASCII) line command can be entered against a regular file that contains data encoded in ASCII and the file is not tagged with a CCSID of 819. The ISPF editor is invoked with the ASCII edit facility which converts the ASCII data

z/OS UNIX directory list utility (option 3.17)

to the CCSID of the terminal, allowing you to read and change the ASCII data in file. If the E line command is used and the file is tagged with a CCSID of 819, ISPF invokes the ASCII edit facility.

EA—edit UTF-8 file

The EU (Edit - UTF-8) line command can be entered against a regular file that contains data encoded in UTF-8 and the file is not tagged with a CCSID of 1208. The ISPF editor is invoked with the UTF-8 edit facility which converts the UTF-8 data to the CCSID of the terminal, allowing you to read and change the UTF-8 data in file. If the E line command is used and the file is tagged with a CCSID of 1208, ISPF invokes the UTF-8 edit facility.

FS—file system

The FS (file system) line command can be entered against any directory entry except a FIFO or character special file. This line command causes the z/OS UNIX File System Attributes panel to be displayed.

```
z/OS UNIX File System Attributes
Command ==> _____
Pathname : /u/myhome/prog1
File system name . . : OMVS.USERS.ISD1
Mount point . . . . : /u
Status . . . . . : Available
File system type . . : HFS
Mount mode . . . . . : R/W
Device number . . . : 7
Type number . . . . : 1
DD name . . . . . : SYS00012
Ignore SETUID . . . : NO
Bypass Security . . : NO
Automove . . . . . : YES
Owning system . . . : ISD1
CCSID . . . . . :
Text Convert . . . . : NO
Seclabel . . . . . :
Block size . . . . . : 4096
Total blocks . . . . : 2880000
Available blocks . . : 2178092
Blocks in use . . . . : 701411
Data blocks read . . . : 0
Data blocks written . . : 0
Directory blocks r/w . : 0
Mount parameters
F1=Help      F2=Split    F3=Exit     F4=Expand   F7=Backward F8=Forward
F9=Swap      F10=Actions F12=Cancel
```

Figure 173. z/OS UNIX File System Attributes panel (ISRUULFS)

This panel displays the attributes of the file system for the file in these fields:

File system name

The name of the data set for the file system.

Mount point

The name of the directory that is the mount point for this file system.

Status One of these values describing the current state of the file system:

Available

The file system is mounted and available for use.

Not Active

The file system is not available for use.

Reset in progress

A reset unmount request is currently being processed.

Unmount drain in progress

The file system will be unmounted when it is no longer in use.

Unmount force in progress

The file system is being unconditionally unmounted.

Unmount immediate in progress

The file system is being unmounted, even though it may be in use.

Unmount in progress

The file system is being unmounted if it is not currently in use.

Pending unmount reset or force

An immediate unmount request failed.

Quiesced by (process ID)

The file system is quiesced, usually for backup.

Mount in progress

The file system is being mounted.

Recycling

The physical file system is in a recycle but a mount has not yet been done for this file system.

Recycling, Asynch Mounting

The physical file system is in a recycle and the file system is in an asynchronous mount.

Recycling, Not Active

The physical file system is in a recycle and the file system failed to successfully mount.

Unowned

The file system has become unowned.

In Recovery

Recovery processing is in progress.

Super Quiesced

The file system is in a super quiesced state.

File system type

The type of physical file system that manages this mounted file system.

Mount mode

Shows whether the file system is mounted read/write (R/W) or read-only(R/O).

Device number

The device number that uniquely identifies the mounted file system. This is a hexadecimal value.

Type number

A number set by the physical file system to indicate the type of this file system. The HFS file system sets this value to 1.

z/OS UNIX directory list utility (option 3.17)

DD name

The MVS data definition name used by the physical file system to access the mounted file system.

Ignore SETUID

This value indicates whether the SETUID and SETGID mode bits on any executable in this file system be ignored when the program is run.

Bypass Security

This value indicates whether security checks are not enforced for files in this file system.

Automove

This value indicates whether the system can automatically move the file system to another system and remain local and unowned, or be unmounted.

Owning system

The name of the system that owns this file system.

CCSID

The coded character set identifier to be implicitly set for untagged files in the file system.

Text Convert

This value indicates whether untagged files are implicitly marked as containing pure text data that can be converted.

Seclabel

This security label assigned to a file system that is mounted read-only. This security label applies to all objects within the file system that do not have security labels assigned.

Block size

The length, in bytes, of a data block for the physical file system.

Total blocks

The total number of 4096-byte blocks in this file system.

Available blocks

The number of 4096-byte blocks in this file system that are available for use.

Blocks in use

The number of 4096-byte blocks in this file system that are currently in use.

Data blocks read

The block I/O count for user data reads. This value is only available if SMF type 92 records are active.

Data blocks written

The block I/O count for user data writes. This value is only available if SMF type 92 records are active.

Directory blocks r/w

The block I/O count for directory I/Os. This value is only available if SMF type 92 records are active.

Mount parameters

The parameters specified with the mount command for this file system.

I—information

The I (information) line command can be entered against any directory entry.

Information display for non-link files: When entered against any directory entry type apart from symbolic and external links, the z/OS UNIX File Information panel is displayed. Figure 174 shows an example.

```

Modify
-----
z/OS UNIX File Information
Command ==> _____ More: +
Pathname . . . : /SYSTEM/etc/profile

General Data                               Mode Fields
File Type . . . : File                     Permissions . . : 755
File Size . . . : 10665                   Set User ID . . : NO
Links . . . . . : 1                       Set Group ID . . : NO
Inode . . . . . : E0                      Sticky Bit . . . : NO
File Format . . . : ----

Last Modified : 2003/07/10 03:21:51       Extended Attributes
Last Changed  : 2003/07/10 03:22:40       Shared AS . . . : YES
Last Accessed : 2006/04/05 01:20:34       APF Auth . . . : NO
Created . . . : 2003/07/10 03:18:18       Pgm Control . . : NO
CCSID . . . . :                          Shared Lib . . . : NO
Text Convert  : NO

Owner                                           Audit
File . . . . . : IBMUSER(0)              Auditor . . . . : ---
User . . . . . : fff
F1=Help      F2=Split    F3=Exit    F4=Expand  F7=Backward F8=Forward
F9=Swap      F10=Actions F12=Cancel

```

Figure 174. z/OS UNIX File Information panel (ISRUULIN)

This panel displays information describing the attributes of a z/OS UNIX file. The Pathname field displays the path name of the selected z/OS UNIX file.

The General Information section of the panel displays these fields:

File Type

The type of z/OS UNIX file. The possible values are:

Dir

Directory

File

Regular file

Char

Character special file

FIFO

FIFO (first-in-first-out) special file

Size The file size, in bytes.

Links For a file, the number of hard links to the file. For a directory, the number of subdirectories.

Inode File identification number, unique within the file system.

File Format

File format for regular files. The possible values are:

---- Not specified

bin Binary data

nl New line

cr Carriage return

lf Line feed

z/OS UNIX directory list utility (option 3.17)

crlf Carriage return followed by line feed

lfcr Line feed followed by carriage return

crnl Carriage return followed by new line

Last Modified

The date and time the file was last changed.

Last Changed

The date and time the status of the file was last changed.

Last Accessed

The date and time the data in the file was last accessed.

Created

The date and time the file was created.

CCSID

The coded character set identifier assigned to the file for Enhanced ASCII support.

Text Convert

A value of YES indicates the file is enabled for Enhanced ASCII automatic conversion. NO indicates the file is not enabled for automatic conversion.

The Owner section of the panel displays these fields:

File The user ID and UID number of the owner of the file or directory.

Group The group name and GID number of the owner of the file or directory.

The Mode Fields section of the panel displays these fields:

Permissions

The file or directory permissions, in octal format. If there are extended access control list (ACL) entries defined for the file or directory, + is displayed after the octal value.

Set User ID

A value of ON indicates the SETUID bit is on causing the effective user ID of the user process executing a program to be set to that of the file owner when this file is run.

Set Group ID

A value of ON indicates the SETGID bit is on causing the effective group ID of the user process executing a program to be set to that of the file owner when this file is run.

Sticky Bit

A value of ON indicates the sticky bit for the file or directory is set on. For files that are programs this causes z/OS UNIX to search for the program in the user's STEPLIB, the link pack area, or the link list concatenation. For a directory it means a user can only remove or rename a file or remove a subdirectory if one of these conditions is true:

- The user owns the file or subdirectory
- The user owns the directory
- The user has superuser authority

The Extended Attributes section of the panel displays these fields:

Shared AS

A value of YES indicates that the program can run in a shared address space.

APF Auth

A value of YES indicates that the program can run APF authorized if it has been linked with AC=1.

Pgm Control

A value of YES indicates that the program can run as if it were from a program controlled library.

Shared Lib

A value of YES indicates that the program is loaded as a system shared library program.

The Audit section of the panel displays these fields:

Auditor

Shows the audit criteria for this file as defined by a user with auditor authority. The value shows three characters describing the audit bit settings for read, write, and execute (search) access. The possible values for each character are:

- s** Audit successful access attempts
- f** Audit failed access attempts
- a** Audit all access attempts
- No audit

User Shows the audit criteria for this file as defined by the file owner or a superuser. See the field Auditor for the possible values displayed.

The Device Data section of the panel displays these fields:

Device Number

A hexadecimal number that uniquely identifies the mounted file system for this file.

Major Device

For a character special file, this is a number that identifies the device type. The possible values are:

- 1** Master pseudo-TTY device, which is tied to a slave device by the minor number
- 2** Slave pseudo-TTY device, which is tied to a master device by the minor number
- 3** Controlling terminal TTY
- 4** Null file
- 5** File descriptor file, which is tied to a file descriptor by the minor number
- 6** UNIX domain socket name special file
- 9** System console file

Minor Device

A number that identifies a specific device of a given device type.

The Modify action bar choice provides these options:

z/OS UNIX directory list utility (option 3.17)

Mode Fields

Displays the Modify z/OS UNIX File Mode Fields panel where you can update the mode fields for the currently displayed file.

Extended Attributes

Displays the Modify z/OS UNIX File Extended Attributes panel where you can update the extended attributes for the currently displayed file.

Information display for link files: When the I line command is entered against a symbolic or external link file, the z/OS UNIX Symbolic Link Information panel is displayed. Figure 175 shows an example.

```
z/OS UNIX Symbolic Link Information
Command ==> _____
Pathname . . . : /SYSTEM/etc/ioepdcf

General Data
External Link : NO
File Size . . : 22
Links . . . . : 1
Inode . . . . : 7
Last Modified : 2002/11/20 19:30:53
Last Changed  : 2002/11/20 19:30:53
Last Accessed : 2002/11/20 19:30:53
Created . . . : 2002/11/20 19:30:53

Owner
File . . . . : IBMUSER(0)
Group . . . . : OMVSRP(1)

Symbolic Link -
../etc/dfs/etc/ioepdcf

F1=Help      F2=Split    F3=Exit     F4=Expand   F7=Backward F8=Forward
F9=Swap      F10=Actions F12=Cancel
```

Figure 175. z/OS UNIX Symbolic Link Information panel (ISRUULIS)

This panel displays information describing the attributes of a z/OS UNIX symbolic or external file. The Pathname field displays the path name of the selected symbolic or external link file.

The General Information section of the panel displays these fields:

External Link

A value of YES indicates the file is an external link to an object outside of the file system. A value of NO indicates the file is a link to another file or a directory.

Size The file size, in bytes.

Links The number of hard links to the file.

Inode File identification number, unique within the file system.

Last Modified

The date and time the file was last changed.

Last Changed

The date and time the status of the file was last changed.

Last Accessed

The date and time the data in the file was last accessed.

Created

The date and time the file was created.

The Owner section of the panel displays these fields:

File The user ID and UID number of the owner of the file or directory.

Group The group name and GID number of the owner of the file or directory.

The Symbolic Link field is a scrollable field that displays the path name or external name to which this symbolic link file refers.

L—directory list

The L (list directory) line command can be entered against a directory. This line command causes a new z/OS UNIX Directory List panel to be displayed, showing the entries for the selected directory. This new directory list display is nested so entering the END or EXIT command on this panel will return you to the previous directory list. Entering the CANCEL command on a nested directory list display will return you to the directory list utility entry panel.

MA—modify ACL

The MA (modify ACL) line command can be entered against any directory or file entry. This line command causes the Modify z/OS UNIX ACL list panel to be displayed.

z/OS UNIX ACL List							Row 1 from 75
Command ==>							Scroll ==> PAGE
S	UID	Read	Write	eXecute	Name	Type	
—	108	R			BILLSWA	USER	
—	607	R			MBOTES	USER	
—	204	R			SCLMU	GROUP	
—	991	R			TGROUP1	GROUP	
—	992	R	W	X	TGROUP2	GROUP	
—	993	R	W		TGROUP3	GROUP	
***** Bottom of data *****							
F1=Help F2=Split F3=Exit F4=Expand F7=Backward F8=Forward							
F9=Swap F10=Actions F12=Cancel							

Figure 176. Modify z/OS UNIX ACL list panel (ISRUULMA)

Panel ISRUULMA may display with no entries indicating that no ACL entries have been created.

The list is sorted in UID order.

z/OS UNIX directory list utility (option 3.17)

You can enter these commands on the command line:

- A** Add a new ACL.
- SA** Sort the ACL list alphabetically by userid.
- SN** Sort the ACL list numerically on UID.
- ST** Sort the ACL list alphabetically by type.

If there are ACL entries displayed, these fields are shown:

- S** Select field. These commands are valid:
 - A** To add further entries.
 - D** To delete the entry.
 - X** To list members of an OMVS group.

UID UNIX UID value.

Read, Write, eXecute

Read, write, and execute permissions for this ACL.

Name The name associated with the UID value.

Type Describes whether the entry is for a USER or GROUP.

MF—modify format

The MF (modify format) line command can be entered against any directory entry except a symbolic link file. This line command causes the Modify z/OS UNIX File Format panel to be displayed.

```
Menu Utilities View Options Help
e
Modify z/OS UNIX File Format
Command ===> _____
Pathname . . : /u/myhome/prog1
Type . . . : File
Format . . . 1  1. NA      3. NL      5. LF      7. LFCR
                2. Binary  4. CR      6. CRLF    8. CRNL
CCSID . . . ____
Enter "/" to select option
_ Automatic Conversion
F1=Help      F2=Split    F3=Exit     F4=Expand   F7=Backward
F8=Forward   F9=Swap     F10=Actions F12=Cancel

F1=Help      F2=Split    F3=Exit     F4=Expand   F7=Backward F8=Forward
F9=Swap      F10=Actions F12=Cancel
```

Figure 177. Modify z/OS UNIX File Format panel (ISRUULMF)

The Pathname field displays the path name of the selected file. The Type field display the file type for the selected file.

The format and tag information for the file can be changed by updating these input fields on the panel:

Format

Enter one of the listed numbers corresponding to one of these formats required for the file:

- NA** No format specified.

Binary

Binary data.

NL Text file; lines delimited by the newline character.**CR** Text file; lines delimited by the carriage-return character.**LF** Text file; lines delimited by the line-feed character.**CRLF** Text file; lines delimited by carriage-return and line-feed characters.**LFCR** Text file; lines delimited by line-feed and carriage-return characters.**CRNL** Text file; lines delimited by carriage-return and newline characters.**CCSID**

Enter the numeric coded character set identifier (CCSID) associated with the file. The numeric value must be between 0 and 65535. You can set this field to blanks or enter a value of 0 to indicate there is no CCSID associated with the file.

Automatic Conversion

Select this option to identify the file as a candidate for automatic conversion provided by z/OS UNIX Enhanced ASCII support.

Note:

1. A superuser or the owner can change the file format of a file.
2. A superuser, the owner, or a user with write permission can change the tag information (CCSID and automatic conversion setting) for a file.
3. File tag information cannot be set for a z/OS UNIX directory. Therefore when processing a directory the CCSID and Automatic Conversion fields are protected.

MG—modify group

The MG (modify group) line command can be entered against any directory entry except a symbolic link file. This line command causes the Modify z/OS UNIX File Owning Group panel to be displayed.

```

Menu Utilities View Options Help
-----
Modify z/OS UNIX File Owning Group
Command ===> _____
Pathname . . : /u/myhome/prog1
Type . . . . : File
GID Number   108
Group ID . . : SYSADMIN

F1=Help      F2=Split    F3=Exit      F4=Expand    F7=Backward
F8=Forward   F9=Swap     F10=Actions  F12=Cancel

F1=Help      F2=Split    F3=Exit      F4=Expand    F7=Backward  F8=Forward
F9=Swap     F10=Actions F12=Cancel

```

Figure 178. Modify z/OS UNIX File Owning Group panel (ISRUULMG)

z/OS UNIX directory list utility (option 3.17)

The Pathname field displays the path name of the selected file. The Type field display the file type for the selected file.

The owning group for the file can be changed by a superuser or the owner by updating one of these input fields on the panel:

GID Number

This field allows you to enter the GID of the new group. This must be a number, in the range 1 to 2147483647, and must be defined as a z/OS UNIX GID in your security data base.

Group ID

This field allows you to enter the group ID of the new group. The group ID must be defined as a z/OS UNIX group in your security data base.

MM—modify mode fields

The MM (modify mode) line command can be entered against any file type apart from symbolic and external link files. This line command causes the Modify z/OS UNIX File Mode Fields panel to be displayed. This panel allows you to modify mode fields for the selected z/OS UNIX file.

The Pathname field displays the path name of the selected file. The Type field display the file type for the selected file.

These optional input fields allow you to make modifications to the mode of the file:

Permissions

This field allows you to change the permissions defined for the file. The current permissions for the file are initially displayed. The permissions are displayed and entered as three octal (range 0-7) digits. The first digit defines the access permission for the file owner. The second digit defines the access permission for any member of the file's group. The third digit defines the access permission for anyone else. See Table 16 on page 276.

Set UID bit

When this option is selected, the file mode SETUID bit is set on. When the option is not selected, the SETUID bit is set off. If the SETUID bit is on, the effective user ID of the user process executing a program will be set to that of the file owner when this file is run.

Set GID bit

When this option is selected, the file mode SETGID bit is set on. When the option is not selected, the SETGID bit is set off. If the SETGID bit is on, the effective group ID of the user process executing a program will be set to that of the file owner when this file is run.

Sticky bit

When this option is selected, the file mode sticky bit is set on. When this option is not selected, the sticky bit is set off. If the sticky bit is on for a file that is a program, z/OS UNIX will search for the program in the user's STEPLIB, the link pack area, or the link list concatenation. If the sticky bit is on for a directory it means a user can only remove or rename a file or remove a subdirectory if one of these conditions is true:

- The user owns the file or subdirectory
- The user owns the directory
- The user has superuser authority

MO—modify owner

The MO (modify owner) line command can be entered against any directory entry except a symbolic link file. This line command causes the Modify z/OS UNIX File Owning User panel to be displayed.

```

Menu Utilities View Options Help

                                Modify z/OS UNIX File Owning User
Command ===>

Pathname . . : /u/myhome/prog1
Type . . . . : File

UID Number   0
User ID     . . IBMUSER

F1=Help      F2=Split    F3=Exit      F4=Expand    F7=Backward
F8=Forward   F9=Swap      F10=Actions  F12=Cancel

F1=Help      F2=Split    F3=Exit      F4=Expand    F7=Backward F8=Forward
F9=Swap      F10=Actions F12=Cancel

```

Figure 179. Modify z/OS UNIX File Owning User panel (ISRUULMO)

The Pathname field displays the path name of the selected file. The Type field displays the file type for the selected file.

The owner of the file can be changed by a superuser by updating one of these input fields on the panel:

UID Number

This field allows you to enter the UID of the new owner. This must be a number, in the range 1 to 2147483647, and must be defined as a z/OS UNIX UID in your security data base.

User ID

This field allows you to enter the user ID of the new owner. The user ID must be defined in your security data base and have the authority to use z/OS UNIX resources.

MX—modify extended attributes

The MX (Modify eXtended) line command can be entered against regular files in the directory list. This line command causes the Modify z/OS UNIX File Extended Attributes panel to be displayed. This panel allows you to modify the extended attributes for the selected z/OS UNIX regular file. These attributes only affect files that are programs.

The Pathname field displays the path name of the selected file. The Type field displays the file type for the selected file.

These optional input fields allow you to modify the extended attributes:

Use Shared Address Space

When this option is selected, ISPF sets the extended attribute that makes the program eligible to run in a shared address space.

z/OS UNIX directory list utility (option 3.17)

APF Authorized

When this option is selected, ISPF sets the extended attribute that makes the program eligible to run APF-authorized if it has been linked with AC=1.

Program Controlled

When this option is selected, ISPF sets the extended attribute that makes the program eligible to run as if it were from a program controlled library.

Shared Library

When this option is selected, ISPF sets the extended attribute that causes the program to be loaded from the system shared library region.

N—create a new directory entry

The N (new) line command can be entered against any directory entry. The Create New z/OS UNIX File panel is displayed.

```

Create New z/OS UNIX File
Command ===> _____
Pathname . . . . /u/sc1mtest _____ +
Permissions . . ___ (Octal)
Link . . . . . _____ +

File Type . . . - 1. Directory          Options
                  2. Regular file      - Set sticky bit
                  3. FIFO                - Copy...
                  4. Symbolic Link      - Edit...
                  5. External Link
                  6. Hard Link

F1=Help      F2=Split      F3=Exit      F4=Expand      F7=Backward
F8=Forward   F9=Swap        F10=Actions  F12=Cancel

```

Figure 180. Create New z/OS UNIX File panel (ISRUULNW)

These mandatory input fields are displayed on this panel:

Pathname

The path name for the z/OS UNIX file to be created. This field is initialized with the path name of the file that the N line command was entered against. The field is scrollable with a length of 1023 bytes. Use the EXPAND function key (F4) to display the entire field in a pop-up window.

Note: In the panel displayed by the N line command, you can specify a "+" (plus) character as the first character of a path name to represent the path name of the directory currently listed.

Permissions

The permissions defined for the new file. Enter as three octal (range 0-7) digits. The first digit defines the access permission for the file owner. The second digit defines the access permission for any member of the file's group. The third digit defines the access permission for anyone else. See Table 16 on page 276.

Link This field is only mandatory when creating a Symbolic Link, External Link, or Hard Link. When creating a Symbolic Link or a Hard Link this field is used to define the path name of the existing file the link refers to. When

creating an External Link this field is used to define the external name the link refers to. The field is scrollable with a length of 1023 bytes. Use the EXPAND function key (F4) to display the entire field in a pop-up window.

File Type

This field is used to enter one of the listed numbers corresponding to the type of file you want to create.

1. Directory
2. Regular file
3. FIFO
4. Symbolic Link
5. External Link
6. Hard Link

These optional fields can be selected on this panel:

Set sticky bit

When this option is selected it causes the sticky bit to be set on for the new file or subdirectory. When the sticky bit is set for a directory, a user cannot remove or rename a file in the directory unless one or more of these is true:

- The user owns the file
- The user owns the directory
- The user has superuser authority

If the sticky bit is set for a program file, when executing the program z/OS UNIX will search for the program in the user's STEPLIB, the link pack area, or the link list concatenation.

Copy When this option is selected and you are creating a new regular file, it causes the Replace z/OS UNIX File panel to be displayed, allowing you to have the data from a z/OS UNIX file, data set, or partitioned data set member copied into the new file. When selected and you are creating a new directory, it causes the Copy Into z/OS UNIX Directory panel to be displayed, allowing you to have the data from members in a partitioned data set copied into files in the new directory.

Edit When this option is selected and you are creating a new regular file, it causes the edit function to be invoked allowing you to create and modify data in the new file.

R—rename a file

The R (rename file) line command can be entered against any directory entry. This line command causes the Rename z/OS UNIX File panel to be displayed. This panel displays the Pathname and Type of the file being renamed. Use the New Pathname field to enter the new name for the file.

Note: In the panel displayed by the R line command, you can specify a "+" (plus) character as the first character of a path name to represent the path name of the directory currently listed.

When you press Enter, ISPF attempts to rename the file. **Attention:** If the New Pathname you specified corresponds to an existing file, the Confirm Rename panel is displayed. In this situation, proceeding with the rename will cause the existing file with the same name to be deleted.

RA—Add to Personal Data Set List

The RA (refadd) line command is used to add the pathname of the selected file or directory to a personal data set list. When the RA line command is entered, the pop-up panel shown here is displayed, allowing you to enter the name of the personal data set where the entry for the pathname is to be added.

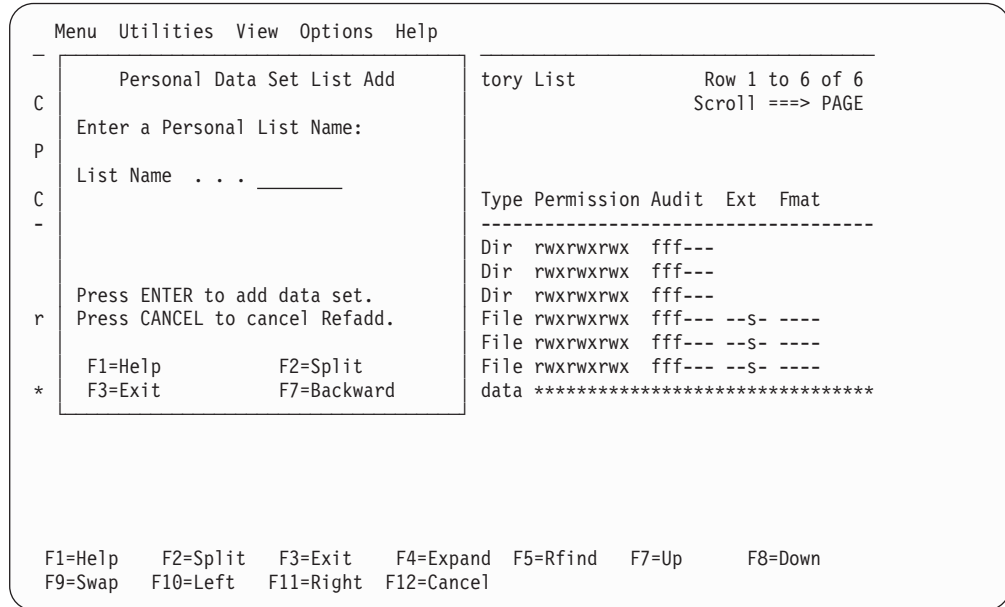

Figure 181. Personal Data Set List Add pop-up panel

UA—user auditing

The UA (user auditing) line command can be entered against any directory entry. This line command causes the Modify z/OS UNIX File User Audit Options panel to be displayed.

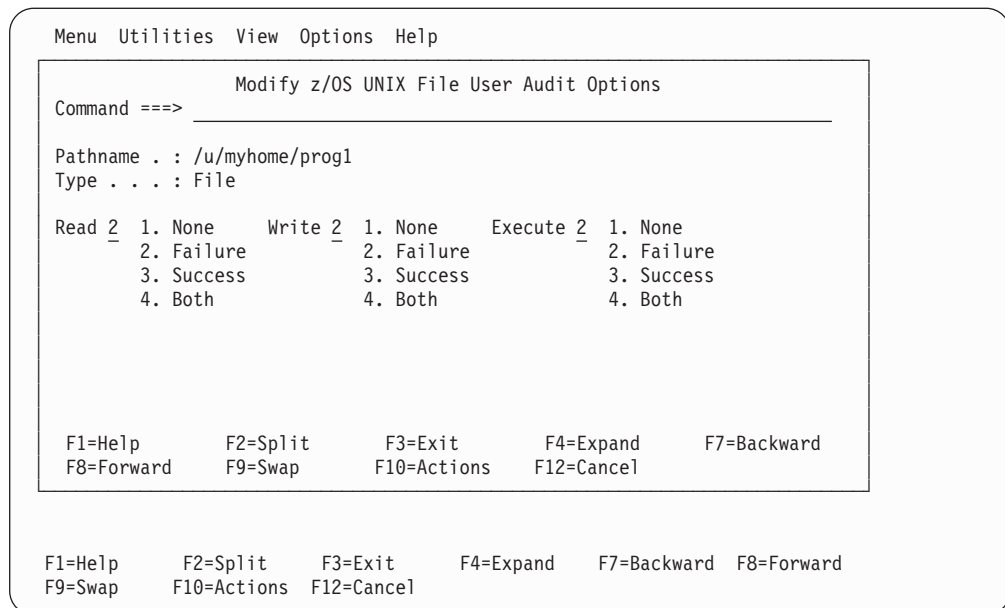

Figure 182. Modify z/OS UNIX File User Audit Options panel (ISRUULUA)

The Pathname field displays the path name of the selected file. The Type field display the file type for the selected file.

The user auditing options for the file can be changed by a superuser or the owner. These options allow you to define the access attempts that are audited by the security system. You can specify auditing to occur for read, write, and search or execute attempts on the file or directory.

The panel displays fields for specifying the Read, Write and Execute (or search) audit settings. For each of these fields, you enter one of the listed numbers corresponding to one of these results for the access attempt:

None No audit record is to be written for this type of access.

Failure

Write an audit record if this type of access fails.

Success

Write an audit record if this type of access is successful.

Both Write an audit record for both failed and successful access attempts.

V—view regular file

The V (view) line command can be entered against a regular file or directory. The ISPF editor is invoked, allowing you to view the data in the file.

If you enter the V line command beside a directory, a directory list is displayed allowing you to select a regular file to view.

The View Entry panel can be displayed when the V line command is entered. This panel allows you specify items including the initial macro, profile name, panel name, format, mixed mode, and workstation editing. These values are stored in the profile and are used on subsequent edits. The **Bypass z/OS UNIX File Edit Options panel** option on the z/OS UNIX Directory List Options panel can be selected to stop this panel being displayed for subsequent file edit sessions.

VA—view ASCII file

The VA (View - ASCII) line command can be entered against a regular file that contains data encoded in ASCII and the file is not tagged with a CCSID of 819. The ISPF editor is invoked with the ASCII edit facility which converts the ASCII data to the CCSID of the terminal, allowing you to view the ASCII data in file. If the V line command is used and the file is tagged with a CCSID of 819, ISPF invokes the ASCII edit facility.

VU—view UTF8 file

The VU (View - UTF8) line command can be entered against a regular file that contains data encoded in UTF8 and the file is not tagged with a CCSID of 1208. The ISPF editor is invoked with the UTF8 edit facility which converts the UTF8 data to the CCSID of the terminal, allowing you to view the UTF8 data in file. If the V line command is used and the file is tagged with a CCSID of 1208, ISPF invokes the UTF8 edit facility.

X—execute command

The X (eXecute command) line command can be entered against regular files, directories, or symbolic links to regular files or directories in the directory list. This line command causes the Execute Command for z/OS UNIX File panel to be displayed.

This panel allows you to enter and execute a z/OS UNIX command, TSO command, CLIST, or REXX EXEC, with the path name of the selected file being passed as a parameter.

The Pathname field displays the path name of the selected file.

z/OS UNIX directory list utility (option 3.17)

These input fields allow you to specify the command and select the method by which it is run:

Command for file

Use this field to enter the z/OS UNIX command, TSO command, CLIST, or REXX exec to be run.

By default, ISPF appends the path name of the selected file to the end of the command you have entered. If you need to have the path name in a position other than the end of the command, use the path name substitution character to indicate where you want the path name to be placed. The default pathname substitution character is ! (exclamation point). For more information about using this symbol, see "Using the path name substitution character" on page 279.

The path name substitution character can also be changed using the Directory List Options panel (see page 314).

If the command is to run in z/OS UNIX by selecting a Run method of Direct or Login shell, then this field can be left blank. This causes the selected file to be executed.

Run method

This field is mandatory. It allows you to select one of these methods for running the command:

Direct Causes the command to be run in z/OS UNIX.

Login shell

Causes the command to be run under the login shell in z/OS UNIX.

TSO Causes the command to be passed to TSO for execution.

z/OS UNIX command time limit

This field allows you to set a limit to the amount of time the command can run. This time limit is entered as a number of seconds. If this limit is exceeded, ISPF sends a SIGKILL signal to the process running the command to terminate execution. If you do not want a time limit set, leave the field blank or enter a value of zero.

The time limit value can also be specified on the Directory List Options panel (see page 314).

z/OS UNIX directory list utility primary commands

These topics describe the primary commands available when using the z/OS UNIX Directory List Utility:

- "EDIT command" on page 309
- "FIND and RFIND commands" on page 309
- "LEFT command" on page 310
- "LOCATE command" on page 310
- "REFRESH command" on page 311
- "RESET command" on page 311
- "RIGHT command" on page 311
- "SAVE command" on page 311
- "SORT command" on page 312
- "SU command" on page 313
- "z/OS UNIX commands" on page 313

Note: If you enter a "/" (forward slash) in the primary command field, ISPF displays a panel with an extended primary command field allowing you to enter commands up to 255 characters in length.

EDIT command

The EDIT primary command is used to edit a file in the directory currently listed. Use this format:



|
|
|

The command can be abbreviated as E, EA, or EU. If EA is used, the editor is invoked with the ASCII edit feature. If EU is used, the editor is invoked with the UTF-8 edit feature.

For example, if the command shown here was entered while displaying the directory list for u/myhome it would invoke Edit for the file with a path name of /u/myhome/prog1:

E prog1

ISPF calls the ISPF editor to edit the file. If the file specified on the EDIT command does not exist in the directory, the ISPF editor is still called and can be used to create a new file in the directory.

FILTER command

The FILTER command is used to append to or replace the current path name filter. If the current display is a personal list, then the filter can only be replaced.



|
|
|

If the current filter is /u/harry/test* then
 FILTER p
 changes the filter to /u/harry/test*p.

The REFRESH command restores the entry value.

FIND and RFIND commands

The FIND primary command is used to find and display the next occurrence of a character string in the list of file names. Use this format:



The command can be abbreviated as F.

For example, this command would tell ISPF to find all occurrences of the character string dat1:

F dat1 ALL

z/OS UNIX directory list utility (option 3.17)

For more information about the operands used with this command, see “FIND—find character strings” on page 85.

ISPF automatically scrolls to bring the character string to the top of the directory list. To repeat the search without re-entering the character string, use the RFINDD command.

Note: The RFINDD search starts from the second file on the current directory list screen. It is not cursor-sensitive.

LEFT command

The LEFT primary command scrolls the columns displaying information for the directory list to the left. These columns do not include the Filename and Message columns, which are fixed as the left-hand columns of the Directory List display. Use this format:

```
▶▶—LEFT—PAGE  
MAX  
n—————▶▶
```

where:

PAGE Specifies to scroll left by the number of columns of data (not counting the fixed fields) that can be displayed within the current screen width. This is the default. P can be used as an abbreviation.

MAX Specifies to scroll left so that the first column of data is displayed in the leftmost position. M can be used as an abbreviation.

n Is a numeric value specifying the number of columns to be scrolled to the left.

Note: If you issue the LEFT command while the cursor is positioned in a scrollable field such as the Filename field, ISPF will scroll the scrollable field and the directory list columns will not be scrolled to the left.

LOCATE command

The LOCATE primary command scrolls the directory list based on the field on which the directory list is sorted, as described under “SORT command” on page 312. Use this format:

```
▶▶—LOCATE—lparm—————▶▶
```

You can use the *lparm* operand with the LOCATE command for either of these situations:

- If the list is sorted by the Filename field, specify a file name.
- If the list is sorted by another field, specify a value for the field by which the list is sorted.

The command can be abbreviated as L.

For example, for a directory list sorted by type, you could enter:

```
L Sym1
```

This command locates the first symbolic link file in the directory list. If the value is not found, the list is displayed starting with the entry before which the specified value would have occurred.

REFRESH command

The REFRESH primary command updates the display of the directory list to whatever the list's current state is. For example, after deleting several items on the list, REFRESH causes the list to be displayed without the deleted items. ISPF rebuilds the directory list display by re-reading the entries for the directory.

The command can be abbreviated as REF



RESET command

The RESET primary command removes any pending line commands and messages from the directory list.

The command can be abbreviated as RES.



RIGHT command

The RIGHT primary command scrolls the columns displaying information for the directory list to the right. These columns do not include the Filename and Message columns, which are fixed as the left-hand columns of the Directory List display. Use this format:



where:

- Page** Specifies to scroll right by the number of columns of data (not counting the fixed fields) that can be displayed within the current screen width. This is the default. P can be used as an abbreviation.
- Max** Specifies to scroll right so that the first column of data is displayed in the rightmost position. M can be used as an abbreviation.
- n** Is a numeric value specifying the number of columns to be scrolled to the right.

Note: If you issue the RIGHT command while the cursor is positioned in a scrollable field such as the Filename field, ISPF will scroll the scrollable field and the directory list columns will not be scrolled to the right.

SAVE command

The SAVE primary command writes the directory list to the ISPF list data set or to a sequential data set. ISPF writes the directory list in its current sort order. Use this format:

z/OS UNIX directory list utility (option 3.17)

```

▶▶ SAVE _____▶▶
    |list-id|

```

where *list-id* is an optional user-specified qualifier of the data set to which the directory list will be written. ISPF names the data set *prefix.userid.list-id.DIRLIST* where:

prefix Your data set prefix, as specified in your TSO user profile. If you have no prefix set, or if your prefix is the same as your user ID, the prefix is omitted and the data set name will be: *userid.list-id.DIRLIST*

userid Your TSO user ID.

If the data set does not exist it is created. If the data set already exists and has compatible attributes it is overwritten. If you omit the *list-id* operand, the list is written to the ISPF list data set.

This command would tell ISPF to write the list to a sequential data set named either *prefix.userid.MY.DIRLIST* or *userid.MY.DIRLIST*:

```
SAVE MY
```

If the sequential data set already exists, ISPF overwrites it; if not, ISPF creates it.

SORT command

The SORT primary command sorts the directory list by the specified field. Use this format:

```

▶▶ SORT _____▶▶
    |field1|
    |  A  |
    |  D  |
    |field2|
    |  A  |
    |  D  |

```

where:

field1 The major sort field. If omitted, Filename is assumed.

field2 The minor sort field. If both operands are used, ISPF sorts the list by *field1* first, then by *field2* within *field1*.

A|D Specifies the sort sequence for the associated sort field (A=ascending; D=descending). By default, character fields are sorted alphabetically and numeric fields are sorted in descending order.

For example, to sort a directory list by file type and then in descending order by modification date and time within each file type, use this command:

```
SORT TYPE MODIFIED
```

This table identifies the sort field names and associated sort sequence:

Table 17. Sort field names and associated sort sequence

Field	Sequence	Description
FILENAME FILE NAME	Ascending	File name
MESSAGE MES	Ascending	Command message
TYPE	Ascending	File type
PERM	Ascending	Permissions
PERMO	Descending	Permissions (octal)
AUDIT AUD	Ascending	Audit bit settings

Table 17. Sort field names and associated sort sequence (continued)

Field	Sequence	Description
EXTA EXT	Ascending	Extended attributes
FORMAT FMAT	Ascending	File format
OWNER OWN	Ascending	File owner
GROUP GRP	Ascending	Owner group
LINKS	Descending	File links
SIZE	Descending	File size
MODIFIED MOD	Descending	Date/time file last changed
CHANGED CHG	Descending	Date/time file status last changed
ACCESSED ACC	Descending	Date/time file status last accessed
CREATED CRE	Descending	Date/time file was created

SU command

The SU primary command allows you to switch to super-user mode (UID 0) or switch back to your initial UID.

For more details, see “Switching UIDs with the SU primary command” on page 318.

z/OS UNIX commands

You can also enter z/OS UNIX commands in the primary command field on the directory list display panel if the option **Enter z/OS UNIX commands in Command field** is selected on the z/OS UNIX Directory List Options panel. These commands run under the login shell in z/OS UNIX.

If you enter / (forward slash) in the primary command field the z/OS UNIX Directory List Command Entry panel is displayed. This panel provides a 255 character length command field for entering long z/OS UNIX and TSO commands. The panel also has a list of point-and-shoot fields showing the last 10 z/OS UNIX commands entered from the z/OS UNIX Directory List Utility. The point-and-shoot fields allow you to retrieve and execute z/OS UNIX commands. The List action bar allows you to activate or deactivate updates to the list. The Mode action bar allows you to specify that commands are just retrieved or retrieved and executed from the list. There is also an option that allows you to delete entries from the list. The Function action bar provides an option to compress null entries from the list.

z/OS UNIX directory list options panels

These topics describe the panels available through the Options pull-down menu:

- “z/OS UNIX Directory List Options panel”
- “z/OS UNIX Directory List Column Arrangement panel” on page 315
- “z/OS UNIX Directory List Default Line Commands panel” on page 315

z/OS UNIX Directory List Options panel

This panel allows you to set and save options that change the behaviour of z/OS UNIX Directory List Utility functions. This panel contains these optional input fields:

Width of filename column

Use this field to define the width of the column used to display file names in the directory list. The minimum value you can specify is 8. The

z/OS UNIX directory list utility (option 3.17)

maximum value is 110. If the value is larger than the screen width minus 50, ISPF uses the screen width minus 50 for the width of the filename column.

Note: The panel field used for the Filename column is defined as scrollable.

Path name substitution character

This field defines the character that can be used to represent the full path name of a selected file. This character shows the position of the file name when it is specified as an argument in a z/OS UNIX command, TSO command, CLIST, or REXX exec. The substitution character can be used with commands that are invoked either as a line command in the directory list or through the Execute Command for z/OS UNIX File panel (see “X—execute command” on page 307). The default character is ! (exclamation point).

z/OS UNIX command time limit

This field allows you to set a limit to the amount of elapsed time for a z/OS UNIX command run either directly or under the login shell. z/OS UNIX commands can be invoked via the X line command (see “X—execute command” on page 307) or by using the line command prefix characters < (direct) or > (login shell) (see “z/OS UNIX commands, TSO commands, CLISTs, and REXX EXECs” on page 277). If the time limit set is exceeded by a z/OS UNIX command, ISPF sends a SIGKILL signal to the process running the command to terminate execution.

If you do not want to set a time limit, leave the field blank or enter a value of zero.

Output Mode

This field allows you to display the output from z/OS UNIX commands in View or Browse mode.

Confirm File Delete

This option controls the display of the Confirm Delete panel. This panel is displayed when you use the directory list line command “D” to delete files or empty directories. When this option is selected, the Confirm Delete panel is displayed. When this option is not selected, the panel is not displayed and the file or empty directory is deleted without any additional user interaction.

Confirm Non-empty Directory Delete

This option controls the display of the Confirm Non-empty Directory Delete panel. This panel is displayed when you use the directory list line command “D” to delete a directory that contains files and subdirectories. When this option is selected, the Confirm Non-empty Directory Delete panel is displayed. When this option is not selected, the panel is not displayed and the directory (including all contained files and subdirectories) is deleted without any additional user interaction.

Bypass z/OS UNIX File Edit Options panel

When this option is selected, ISPF will not display the z/OS UNIX File Edit Options panel when the directory list line command “E” is used to edit a regular file. When this option is not selected, this panel, which allows you to specify an edit profile and initial edit macro, will be displayed before editing a regular file.

Display permissions in octal format

When this option is selected, permissions for files in the directory list are displayed in octal format. When this option is not selected, permissions are displayed in symbolic format.

z/OS UNIX Directory List Column Arrangement panel

This panel allows you to alter the order and width of the columns displayed on the directory list panel. It lists each column in the z/OS UNIX Directory List. These fields are displayed for each entry:

Restore default column arrangements

Selecting this option allows you to reset the Order and Width values used to format the directory list display to their default values.

Order This input field displays the current ordinal position for the column on the directory list display. You can update the value in this field to alter the position of this column on the directory list display. For example, to move the Owner field to be the second column displayed, type 02 over its current Order number and press Enter. The list of Columns is rearranged to show the Owner field in the second position. When you next display a directory list, the columns are shown in the new order:

Pathname . : /

Command	Filename	Message	Type	Owner	Permission	Audit	Ext
	bin		Dir	IBMUSER	rwxr-xr-x	fff---	
	dev		Syml	IBMUSER	rwxrwxrwx	fff---	
	etc		Syml	IBMUSER	rwxrwxrwx	fff---	

Column

This output field displays the heading for the column on the directory list display.

Width This input field displays the current width for the field for the column on the directory list display. You can update this value to increase or decrease the size of the field for the column. Setting the width value to 0 (zero) means the column will not be displayed in the directory list.

Maximum

This output field displays the maximum value that can be entered in the Width field.

z/OS UNIX Directory List Default Line Commands panel

This panel allows you to set and save the default line commands for the different z/OS UNIX file types displayed in a z/OS UNIX directory list. The default line command for a file type is invoked when the cursor is positioned in the line command field for a file of that type, the Enter key is pressed but a command is not entered in the field. This panel contains these input fields:

Directory

Use this field to define the default line command for directories. The valid values are:

- CO
- CI
- N
- L (default)
- I
- D
- R

z/OS UNIX directory list utility (option 3.17)

- MM
- MO
- MG
- MF
- X
- UA
- AA
- FS

Regular file

Use this field to define the default line command for regular files. The valid values are:

- E
- EA
- V
- VA
- B (default)
- CO
- CI
- N
- I
- D
- R
- MM
- MX
- MO
- MG
- MF
- X
- UA
- AA
- FS
- RA

Character special

Use this field to define the default line command for character special files. The valid values are:

- N
- I (default)
- D
- R
- MM
- MO
- MG
- MF
- UA
- AA

FIFO Use this field to define the default line command for FIFO files. The valid values are:

- N
- I (default)
- D
- R
- MM
- MO
- MG

- MF
- UA
- AA

Symbolic link

Use this field to define the default line command for symbolic link files. The valid values are:

- E
- EA
- V
- VA
- B
- CO
- CI
- N
- I (default)
- D
- R
- X

Use of scrollable fields for path names

Because path names can be up to 1023 characters in length, ISPF uses scrollable fields throughout the z/OS UNIX Directory List Utility for the display and entry of path names.

For path name output fields, if a + (scroll indicator) is displayed to the right of the path name it indicates that the path name is larger than the display field length. The RIGHT primary command can be used to view more of the path name by scrolling the value right. Use the EXPAND function key (F4) to display the entire path name field in a pop-up window.

For path name input fields the + scroll indicator is always displayed to the right of the path name, indicating that you can enter a path name larger than the input field length. The RIGHT primary command can be used to obtain more input space by scrolling the value right. Use the EXPAND function key (F4) to display the entire path name input field in a pop-up window.

Switching to super-user (UID 0) mode and back

On the entry panel and the directory list display panel, you can switch to super-user mode (UID 0) or switch back to your initial UID with either:

- The Options pull-down menu, or
- The SU primary command

Switching UIDs with the Options pull-down menu

The Options pull-down menu available on the entry panel and the directory list display panel provides an option that lets you switch to super-user mode (UID 0) or switch back to your initial UID.

When you are operating under your UID, the Options pull-down menu displays this option:

3. Enable superuser mode(SU)

Note: If you select this option, and you have permission to the BPX.SUPERUSER facility class, you are switched to UID 0 (super-user mode).

z/OS UNIX directory list utility (option 3.17)

When you are operating in super-user mode, the Options pull-down menu displays this option:

3. Reset UID to *nnn*

If you select this option, you are switched back to your UID *nnn*.

Switching UIDs with the SU primary command

From the entry or directory list panels, you can switch to super-user mode (UID 0) or switch back to your initial UID with the SU primary command. Use this format:

►►—SU—┐
 └─UIDnum─┘

where:

UIDnum

The UID to which you want to switch.

Note: To switch to another UID, you must have permission to the BPX.DAEMON facility class (if defined).

If you do not specify a UID number, you are switched either to UID 0 (if you are currently operating under your UID), or reset back to your UID (if you are currently operating in super-user mode).

Chapter 6. Foreground (option 4)

The Foreground option (4) allows ISPF to run the foreground processors shown on the Foreground Selection panel, Figure 183. All these processors except for COBOL interactive debug, SCRIPT/VS, and FORTRAN interactive debug are also available with the Batch option (5).

When you run a foreground processor, you must wait until the processor ends before doing anything else with ISPF. If you want to use ISPF while waiting for the processor to end, submit the input as a batch job. You can do this by using the Batch option if the processor you need is listed on the Batch Selection panel, Figure 202 on page 353.

```
Menu  Utilities  Help
-----
                                Foreground Selection Panel

1   Assembler                    11  *FORTRAN debug
2   COBOL                         12  Member Parts List
3   VS FORTRAN                    13  *C/370
5   PL/I                          14  *REXX/370
6   VS PASCAL                     15  *ADA/370
7   *Binder/Link editor           16  *AD/Cycle C/370
9   SCRIPT/VS                     18  ISPD TLC
10  *VS COBOL II debug            19  *OS/390 C/C++
10A *OS/VS COBOL debug

Enter "/" to select option      * No packed data support
  _ Source Data Packed

Option ==>
F1=Help   F2=Split   F3=Exit   F7=Backward  F8=Forward  F9=Swap
F10=Actions F12=Cancel
```

Figure 183. Foreground Selection Panel (ISRFPFA)

The names of the foreground processors on this panel are point-and-shoot fields. For more information, see the Point-and-Shoot Text Fields section of the ISPF User Interface topic of the *z/OS ISPF User's Guide Vol I*.

Foreground selection panel action bar

The Foreground Selection Panel action bar choices function as follows:

Menu For more information, see the details about the Menu Action Bar Choice in the ISPF User Interface topic in the *z/OS ISPF User's Guide Vol I*.

Utilities

For more information, see the details about the Utilities Action Bar Choice in the ISPF User Interface topic in the *z/OS ISPF User's Guide Vol I*.

Foreground (option 4)

Help The Help pull-down provides general information about foreground processing as well as information about each available choice on the Foreground Selection Panel.

Foreground processing sequence

This topic describes the main sequence for foreground processing.

1. If you do not know whether the source data is in packed format, find out by editing the data set and entering the PROFILE command. If the source data is in packed format, the profile shows PACK ON.

If the data is packed, select the Source Data Packed option. If the data is not packed, deselect this option.

Also, you should read “Expanding packed data” on page 323, paying close attention to:

- Information that applies to the foreground processor you plan to use.
- The difference between expanding a sequential data set and expanding members of a partitioned data set.

When you are satisfied that the data set is ready to be processed, continue with the next step.

2. Select one of the foreground processors listed at the top of the Foreground Selection panel shown in Figure 183 on page 319.

Note: A region size of 2 megabytes or more will probably be required to run the VS FORTRAN compiler in the foreground.

3. Select the Source Data Packed option to tell ISPF if it needs to expand the source data.

Note: The Source Data Packed option has no effect on the Member parts list option (4.12). Member parts list can read both packed and unpacked data sets, so no expansion is needed.

4. When the Session Manager licensed program, 5740-XE2, is installed, you can select the Session Manager mode option on the ISPF Settings panel so that you enter Session Manager mode when you call any of the foreground processors. Once you call Session Manager, it stays in effect for all logical screens until you turn it off. For example, if you call Session Manager and then split the screen, Session Manager will be in effect on both logical screens.

Note: If graphics interface mode is active, Session Manager does not get control of the screen. Graphics interface mode is started when a GRINIT service has been issued, but a GRTERM service has not been issued. See *z/OS ISPF Services Guide* for more information about these two services.

5. Press Enter. ISPF displays the data entry panel for the processor you selected. The remainder of this processing sequence applies to all foreground processors except SCRIPT/VS, VS COBOL II interactive debug, COBOL interactive debug, and Member Parts List. For these processors, use the sequence referred to in this list:

Processor

Reference

SCRIPT/VS

“SCRIPT/VS processor (option 4.9)” on page 336

VS COBOL II interactive debug

“VS COBOL II interactive debug (option 4.10)” on page 343

COBOL interactive debug

“OS/VS COBOL debug (option 4.10A)” on page 343

Member parts list

“Member parts list (option 4.12)” on page 347

6. Enter the appropriate ISPF library and concatenation sequence or data set name. If the input data set is partitioned, you can leave the member name blank or use a pattern to display a member list. If you need help, see:
 - The Naming ISPF Libraries and Data Sets section of the “ISPF Libraries and Data Sets” chapter of the *z/OS ISPF User’s Guide Vol I* for help in entering library or data set names
 - The Displaying Member Lists section of the “ISPF Libraries and Data Sets” chapter of the *z/OS ISPF User’s Guide Vol I* for information about patterns and displaying member lists
 - “Input data sets” on page 326 for information about the regular concatenation sequence
 - “Object data sets” on page 328 for information about object modules
 - “Linkage editor concatenation sequence” on page 336 for help with the linkage editor concatenation sequence

VS FORTRAN has no LIB option, which some foreground processors use to specify the input data set concatenation sequence. Therefore, the concatenation sequence specified in the Group fields is used to find the member to be compiled.

For FORTRAN interactive debug, the TYPE, or last qualifier, must be either OBJ or LOAD. However, if you specify an OBJ data set as your input data set, you must include a load library or data set in the input search sequence (see step 11).

7. This step applies to FORTRAN interactive debug only. Use the Source Type field to tell ISPF the Type, or last qualifier, of the data set used to create the input object module or load module.
8. Use the List ID field to tell ISPF what to name the output listing. See “List data sets” on page 327 for more information.
9. Enter your password in the Password field if your input data set is password-protected. See “Password protection” on page 328 for more information.
10. The Option field, whether ASSEMBLER, COMPILER, LINKAGE EDITOR, or DEBUG, is remembered from one session to another. Therefore, you do not need to change this field unless the options you need are not displayed.

Be careful not to enter any options that ISPF generates automatically. These options are listed on the data entry panel. For more information about the options available for your processor, refer to the documentation supplied with that processor.
11. Enter any additional input libraries you need. For FORTRAN interactive debug, enter any input LOAD libraries that you need to complete the search sequence. These libraries must be LOAD libraries only. See “Input data sets” on page 326 if you need help.
12. Once all the input fields have been specified, press Enter to call the foreground processor.

If the Session Manager is installed and you selected Session Manager mode on the ISPF Settings panel, the foreground processor and all function keys and PA keys are under the control of the Session Manager. When foreground processing is complete, you are prompted to enter a null line to return to ISPF control.

Foreground—processing sequence

If the Session Manager is not called, the PA and function keys have their usual TSO-defined meanings; generally, the function keys are treated the same as the Enter key.

13. Communication with foreground processors is in line-I/O mode. Whenever you see three asterisks, press Enter.
14. If the foreground processor generated an output listing, the listing is displayed automatically in Browse mode.

Note: If a Foreground processing program ends abnormally, ISPF displays a message in the upper-right corner of the screen and does not enter Browse mode. The list data set is retained, but the Foreground Print Options panel (see step 15) is not displayed.

You can scroll the output up or down using the scroll commands. All the Browse commands are available to you. When you finish browsing the listing, enter the END command.

15. An optional print utility exit routine can be installed by your system programmer. If this exit routine is installed, it may cause the Foreground option's response to differ from the descriptions shown here. See *z/OS ISPF Planning and Customizing* for more information about the print utility exit.
Another factor that can affect the performance of the Foreground option is whether the TSO/E Information Center Facility is installed. If the TSO/E Information Center Facility is installed, your installation can optionally allow ISPF to display a panel for submitting TSO/E Information Center Facility information with the print request. See Figure 185 on page 329 for an example of this panel and “Using the TSO/E information center facility” on page 187 for information about the fields on this panel. If the TSO/E Information Center Facility is not installed, the Foreground option displays the panel shown in Figure 184 to allow you to print, keep, or delete the output.

```

                                Foreground Print Options

PK  Print data set and keep          K  Keep data set (without printing)
PD  Print data set and delete        D  Delete data set (without printing)

If END command is entered, data set is kept without printing.

Data set name . . :

Print mode . . . BATCH                (Batch or Local)

Batch SYSOUT class . . _____
Local Printer id or
  writer-name. . . _____ (For local printer)
Local SYSOUT class . . _____

Job statement information:            (Required for system printer)
===> _____
===> _____
===> _____
===> _____

Option  ===>
F1=HELP   F2=      F3=END   F4=DATASETS  F5=FIND   F6=CHANGE
F9=SWAP   F10=LEFT F11=RIGHT F12=SUBMIT
```

Figure 184. Foreground Print Options panel (ISRFPPRT)

On this panel, the “Data set name” field shows the name of the list data set that contains the output generated by the processor you selected. In the

Option field, enter one of the options shown at the top of the panel. The “Print mode”, “Batch SYSOUT class”, “Local Printer id or writer name”, and Local SYSOUT Class fields on this panel are described under “Hardcopy utility (option 3.6)” on page 184. The “Job statement information” field is described under the Job Statement Information section of the “ISPF Libraries and Data Sets” chapter of the *z/OS ISPF User’s Guide Vol I*.

When you press Enter, the processor entry panel is displayed again. A message indicating completion of the process is displayed in the upper-right corner of the screen.

16. You can perform one of these actions:
 - Enter other parameters and call the same processor.
 - Enter the END command to return to the Foreground Selection panel and select another processor.
 - Enter the RETURN command to go to the ISPF Primary Option Menu.
 - Use the jump function (=) to choose any primary option.

Expanding packed data

Packed data is data in which ISPF has replaced any repeating characters with a sequence showing how many times the character is repeated. Packing data allows you to use direct access storage devices (DASD) more efficiently because the stored data occupies less space than it would otherwise.

If the source data that you want to process is packed, it must be expanded before it can be successfully processed by any of the language processors. Which expansion method you should use depends on whether your source data is:

- A sequential data set that contains expansion triggers

An *expansion trigger* is a keyword that tells ISPF to expand additional data before copying, including, or imbedding it in the source data. Examples are INCLUDE and COPY statements, and SCRIPT .IM (imbed) control words. For information about defining your own expansion triggers, refer to *z/OS ISPF Planning and Customizing*.

ISPF does not recognize expansion triggers in data stored as a sequential data set. Therefore, for this type of data, you should follow these steps:

 1. Manually expand the data that is to be copied, included, or imbedded in your source data. To do this, edit the source data, enter the PACK OFF command, and then save the data. When you have finished processing the data, you can repack it by editing it again and entering PACK ON.
 2. Select the Source Data Packed option before calling one of the language processors.
- Either of these:
 - A sequential data set that does not contain expansion triggers
 - Any member of a partitioned data set, either with or without expansion triggers.

ISPF does recognize expansion triggers in data stored as members of a partitioned data set. Also, if your source data does not contain expansion triggers, you do not have to be concerned with them. Therefore, for these two types of data, select the Source Data Packed option before calling one of the language processors.

In each of the preceding situations, selecting the Source Data Packed option causes ISPF to expand packed source data before it is processed. For partitioned data sets,

Foreground—expanding packed data

any included members are also expanded inline where the INCLUDE or COPY statements, .IM SCRIPT control words, or other user-defined trigger statements are found.

Member expansion (ISRLEMEX)

Member expansion uses simple language scanners to find expansion triggers. If you specify that the source data is not packed, the ISRSCAN program is used. However, if you specify that the source data is packed, member expansion uses the ISRLEMEX program.

These scanners do not have all the sophistication of the actual language processors. Therefore, unusual code or code that does not compile cannot be successfully processed by member expansion. Examples are trigger statements:

- With comments that extend onto the next line
- That have compiler instructions to change the content of the code to be included.

Compiler control statements and symbolic substitution are not considered during member expansion. Instead, ISRLEMEX creates a temporary data set to be used as input to the language processor. All members to be processed, including members imbedded with COPY, INCLUDE, or .IM statements, are copied into this data set, expanded, and passed on to the language processor. The temporary data set will have the same block size as the input data set that contains your source data.

When using languages that allow multiple compilations, such as VS FORTRAN, you must put the source statement that ends the program in your original, or top-level, program. This statement cannot be in an included member.

Table 18 shows the languages processed by member expansion, their expansion triggers, syntax, and the input columns processed for fixed-record data and variable-record data.

Table 18. Expansion triggers and syntax

Language	Expansion Trigger	Syntax	Input Columns Processed for F/FB Format	Input Columns Processed for V/VB Format
Assembler	COPY	COPY name	1 - 80	N/A
PL/I	%INCLUDE	%INCLUDE DDNAME(name); %INCLUDE name;	2 - 72	10 - 100
COBOL	COPY	COPY name.	7 - 72	N/A
VS FORTRAN	INCLUDE	INCLUDE (name)	1 - 72	N/A
Pascal	%INCLUDE	%INCLUDE name; %INCLUDE DDNAME(name);	1 - 72	1 - 100
SCRIPT	.IM	.IM name .IM (name) .IM ('name')	1-reclength or 9-reclength	1-reclength or 1-(reclength-8)
All languages	User-trigger	User-trigger name	N/A	N/A

Restrictions on member expansion and member parts lists

These restrictions apply only to the member expansion and member parts listing functions:

- These restrictions apply to all languages:

- Expansion triggers must follow their respective language coding conventions unless otherwise noted.
- Multiple names and preprocessor variables on trigger statements are not permitted.
- User triggers and their start column are specified at installation time and must be:
 - No more than 20 characters long
 - Uppercase with no imbedded blanks.No part of the user trigger can be in a comment or continuation field.
- Macros cannot be in packed form.
- The trigger statement must be the only statement in the logical record. No continuation is allowed into or from a trigger statement. Also, the trigger keyword must be the first character on the trigger statement that is not a blank and can be followed by only one statement delimiter.
- For compilers that allow names longer than 8 characters, the name is truncated at 8.
- For compilers that allow uppercase and lowercase names, all referenced names are converted to uppercase.
- This restriction applies to assembler only:
 - The user trigger cannot start in column 1.
- This restriction applies to FORTRAN only:
 - The member expansion function allows only the fixed form of coding.
- This restriction applies to PL/I, Pascal, and COBOL:
 - Free form coding is allowed except in trigger statements.
- Other COBOL restrictions are:
 - The name is truncated at 8 characters or the first hyphen (-), whichever comes first.
 - The first statement in the COBOL program must be either an expansion trigger, a valid COBOL division header, a TITLE, a PROCESS, or a CBL statement. The expansion trigger can precede all other statements, but it must start in FIELD B.

If an expansion trigger is the first statement, it must eventually resolve (through multiple expansion triggers if needed) to a valid COBOL division header, TITLE, PROCESS, or CBL statement.
 - In the COPY statement, the text-name is the only value processed. The statement must end on the same line as the COPY keyword with a period followed by a space. If any option is found, the COPY statement is not expanded.
 - In the IDENTIFICATION DIVISION, the division header or paragraph header statements must be blank except for the division or paragraph name. The trigger statement must be on the next line that is neither blank nor a comment.
 - In all other divisions, the trigger statement (line) can be on any line in the division.
 - If the WITH DEBUGGING MODE clause is not found in the SOURCE COMPUTER paragraph, all debug lines are passed to the compiler without being scanned for expansion triggers, as if they were comment lines. If the clause is found, valid trigger statements found on debug lines are expanded and a D is inserted in column 7 of all the non-comment, non-continuation lines included.

Foreground—member expansion (ISRLEMX)

- Any character found in FIELD A that is not a blank causes the end of the paragraph form of the NOTE statement.
- These are SCRIPT/VS restrictions:
 - The .im statement must be the only statement in the logical record and must start in the first valid column. The first logical record is tested for line numbers, as follows:
 - For fixed-length records, if the last 8 characters are all numeric, they are skipped for the complete library.
 - For variable-length records, if the first 8 characters are all numeric, processing begins with column 9.
 - The statements can be in either uppercase, lowercase, or mixed case.
 - Because ISPF creates a sequential data set from the imbedded members, use of the .EF control word will cause all statements in the sequential data set following the .EF to be ignored. The use of .EF is not recommended with packed data.

Member expansion ISRLEMX return codes

Table 19 describes the ISRLEMX return codes.

Table 19. ISRSCAN and ISRLEMX return codes

ISRSCAN		ISRLEMX	
12	Member not found.	1-15	Parameter <i>n</i> was too long, where <i>n</i> = 1 to 15.
16	OPEN error on DDNAME=IN.	16	Too many parameters.
20	I/O error on DDNAME=IN.	17	Too few parameters.
24	OPEN error on DDNAME=OUT.	20	Severe error in expand module. An error message should be printed in the ISRLMSG data set.
28	I/O error on DDNAME=OUT.		

Trigger statement errors

Some of the more common errors that occur are:

- Restricted option.
- Statement on more than one line.
- Referenced member name not found.

If an error occurs, the trigger statement is not expanded and is passed to the language processor.

In SCRIPT/VS, if the error was found in a user trigger, one blank line is inserted before and after the statement in question.

Input data sets

Input to a foreground processor is either:

- A member of an ISPF library or other partitioned data set. If you do not specify a member name, ISPF displays a member list, or
- A sequential data set

If an ISPF library is the input source, the member can be in any library in the concatenation sequence. You can include additional input by using:

- The COPY statement for assembler and COBOL.
- The INCLUDE statement for PL/I, FORTRAN, and Pascal.
- The SCRIPT/VS imbed control word (.im).
- Macros
- Additional input libraries.

Whenever the input source is partitioned, you can specify additional input libraries. They must be partitioned data sets that are not password protected. You cannot specify additional input libraries if the input source is sequential. Specify the fully qualified data set names, enclosed in apostrophes, such as:

```
Additional input libraries:
====> 'ABC.MACROS'
```

For example, in Figure 186 on page 330, a concatenation sequence of three ISPF data sets and one additional input library has been specified. The concatenation order is:

```
ISPFDEMO.XXX.ASM
ISPFDEMO.A.ASM
ISPFDEMO.MASTER.ASM
ISPFTEST.FLAG.ASM
```

The last data set in the concatenation sequence, ISPFTEST.FLAG.ASM, is entered as an additional input library at the bottom of the panel. Additional input libraries are always last in the sequence.

Before calling a foreground processor, ISPF scans the concatenated sequence of libraries to find the member to be processed. For this example, the member name is TOP. If member TOP first appears in data set ISPFDEMO.A.ASM, this prompter command would be generated by Assembler XF.

```
ASM 'ISPFDEMO.A.ASM(TOP)'
LIB('SYS1.MACLIB',
    'ISPFDEMO.XXX.ASM',
    'ISPFDEMO.A.ASM',
    'ISPFDEMO.MASTER.ASM',
    'ISPFTEST.FLAG.ASM')
LOAD('ISPFDEMO.XXX.OBJ(TOP)')
PRINT(LISTASM)
LIST,TEST,TERM,RENT
```

The processor options are passed to the prompter exactly as you specify them.

Note: The macro library SYS1.MACLIB is included in the concatenation sequence for Assembler only. When included, as the preceding prompter command example shows, it is always first in the sequence because of its large block size.

List data sets

In the List ID field, you can enter the name you want ISPF to use to identify the list data set that will contain the foreground processor output. This name is passed to the foreground processor by either the LIST or PRINT option. These rules apply:

- If the input data set is partitioned the List ID field is optional:
 - Leave the List ID field blank if you want ISPF to use the input member name to identify the output list data set.
 - Enter a LIST ID if you want to use a name other than the input member name to identify the output list data set.
- If the input data set is sequential, you must enter a LIST ID.

Foreground—list data sets

For best results, if you plan to debug your program later using COBOL interactive debug:

- Enter the name of the member being compiled in the List ID field if the input data set is partitioned.
- If the input data set is sequential, enter the name of the sequential data set.

Then, when you debug your program, use these same names in the PROG ID fields on the COBOL Interactive Debug panel.

ISPF names the listing:

```
prefix.userid.listid.LIST
```

where

prefix

is the data set prefix in your TSO profile, if you have one and if it is different from your user ID,

userid

is your user ID, and

listid

is the member name or the value in the List ID field.

If you are using the same list data set for multiple job steps, be aware that the DCB information can differ between the language processors and the linkage editor, causing an I/O error when trying to read the list data set. We suggest that you use a different list ID for each job step.

Password protection

Input, object, interpretable text (ITEXT), and symbolic debug data sets can be password-protected. You can specify the password in the Password field on the foreground processor data entry panel. The password does not appear on the screen when you enter it, but ISPF remembers it.

Since foreground processor panels have only one Password field, ISPF prompts you if all data sets do not have the same password.

Object data sets

The information shown here about object data sets applies to all foreground assemblers and compilers. However, if you are using the VS FORTRAN compiler, you must enter OBJECT in the Other field to generate an output object module. The two assemblers and the other compilers generate object modules automatically.

If you specify an ISPF library as the input source, ISPF writes object output from the foreground assembler or compiler to a partitioned data set. This data set has the same name as the first library in the concatenation sequence, but has a type of OBJ. For example, if you specify PROJECT.LIB1.ASM as the first library name, the object output is placed in data set PROJECT.LIB1.OBJ. The member name of the object module is the same as the input member.

If you specify another data set, the object output is placed in a data set of the same name, but with the last qualifier replaced by OBJ. If the data set name has only

one qualifier, OBJ is appended as the last qualifier. For example, if you specify an input data set named OTHER.ASM or OTHER, the object output is placed in a data set named OTHER.OBJ. For partitioned data sets, the object output is stored in a member with the same name as the input member. For sequential data sets, the object output is stored in a sequential data set.

Note: The object data set must exist before invoking a foreground or batch option that creates an object module.

Foreground—TSO/E information center facility

If the TSO/E Information Center Facility is installed, your installation can optionally allow ISPF to substitute the panel shown in Figure 185 for the panel shown in Figure 184 on page 322. This panel is valid for all foreground processors except SCRIPT/VS and member parts list. See “Using the TSO/E information center facility” on page 187 for information about the fields on this panel.

Foreground Print Options

PK Print data set and keep	K Keep data set (without printing)
PD Print data set and delete	D Delete data set (without printing)

If END command is entered, data set is kept without printing.

Data set name . . . :

Printer Location . . _____

Printer Format . . . _____

Number of copies . . ____

Option ==>

F1=HELP	F2=	F3=END	F4=DATASETS	F5=FIN	F6=CHANGE
F9=SWAP	F10=LEFT	F11=RIGHT	F12=SUBMIT		

Figure 185. Foreground Print Options panel with TSO/E information center facility (ISRFPPRI)

Assembler (option 4.1)

Foreground Assembler enables you to use either High Level Assembler or Assembler H. Both are called from the Foreground Assembler panel, shown in Figure 186 on page 330. For information about Assembler data sets, see the topic about Allocation Data Sets in the *z/OS ISPF User's Guide Vol I*.

Foreground—Assembler (option 4.1)

```
Menu  RefList  Utilities  Help
-----
                                Foreground Assembler
                                More:  +
ISPF Library:
Project . . . MYPROJ
Group . . . DEV . . . . .
Type . . .
Member . . . (Blank or pattern for member selection list)

Other Partitioned or Sequential Data Set:
Data Set Name . .

List ID . . . Assembler
Password . . . 1 1. High Level Assembler 2. Assembler H

Assembler Options: (options OBJECT and LIST generated automatically)
====>

Additional input libraries:
====>

Command ====>
F1=Help      F2=Split    F3=Exit     F7=Backward F8=Forward  F9=Swap
F10=Actions  F12=Cancel
```

Figure 186. Foreground Assembler panel (ISRFP01)

All the fields on this panel are explained in the “ISPF Libraries and Data Sets” chapter of the *z/OS ISPF User’s Guide Vol I*, except List ID, which is explained in “List data sets” on page 327, “Additional input libraries”, which is explained in “Input data sets” on page 326, and here:

Assembler Options

Be careful not to enter the OBJECT and LIST options in this field. ISPF generates these options automatically. OBJECT writes the output object module to a partitioned data set. LIST writes the output listing to a list data set. See “Object data sets” on page 328 and “List data sets” on page 327 for more information.

Assembler

Enables you to specify whether to use High Level Assembler or Assembler H. Specify 1 for High Level Assembler or 2 for Assembler H.

COBOL (option 4.2)

ISPF generates an ISPEXEC SELECT PGM(IGYCRCTL) statement to invoke a COBOL compiler using the values you enter on the Foreground COBOL Compile panel, shown in Figure 187 on page 331. For information about COBOL allocation data sets, see the topic about Allocation Data Sets in the *z/OS ISPF User’s Guide Vol I*.

```

Menu  RefList  Utilities  Help
-----
                          Foreground COBOL Compile
                          More:      +

ISPF Library:
Project . . . MYPROJ
Group . . . DEV . . . _____ . . . _____
Type . . . _____
Member . . . _____ (Blank or pattern for member selection list)

Other Partitioned or Sequential Data Set:
Data Set Name . . _____

List ID . . . . . _____ Password . .

Compiler options: (options LIB and OBJECT generated automatically)
Test . . . NOTEST (TEST or NOTEST)
Other . . . _____

Additional input libraries:
====>
Command ====> _____
F1=Help   F2=Split   F3=Exit   F7=Backward F8=Forward F9=Swap
F10=Actions F12=Cancel

```

Figure 187. Foreground COBOL Compile panel (ISRFP02)

All the fields on this panel are explained in the “ISPF Libraries and Data Sets” chapter of the *z/OS ISPF User’s Guide Vol I* except List ID, which is explained in “List data sets” on page 327, “Additional input libraries”, which is explained in “Input data sets” on page 326, and here:

Test If you plan to run interactive debug after you compile your program, enter TEST in the Test field. Otherwise, enter NOTEST.

Other If you plan to run VS COBOL II interactive debug after you compile your program, enter RESIDENT in the Other field. Otherwise, just enter any other options you need.

Be careful not to enter the LIB and OBJECT options in the Other field. ISPF generates these options automatically. LIB specifies the input data set concatenation sequence. OBJECT writes the output object module to a partitioned data set. See “Input data sets” on page 326 and “Object data sets” on page 328 for more information.

VS FORTRAN compile (option 4.3)

The Foreground VS FORTRAN Compile panel is shown in Figure 188 on page 332.

Foreground—VS FORTRAN compile (option 4.3)

```
Menu  RefList  Utilities  Help
-----
                          Foreground VS FORTRAN Compile
                                          More:  +

ISPF Library:
Project . . . MYPROJ
Group . . . DEV . . . . .
Type . . . .
Member . . . . (Blank or pattern for member selection list)

Other Partitioned or Sequential Data Set:
Data Set Name . . . . .

List ID . . . . . Password . . . . .

Compiler options:
Object . . . . (OBJECT or NOOBJECT)
Other . . . . .

Additional input libraries:
====>
Command ====>
F1=Help      F2=Split      F3=Exit      F7=Backward  F8=Forward  F9=Swap
F10=Actions  F12=Cancel
```

Figure 188. Foreground VS FORTRAN Compile panel (ISRFP03)

All the fields on this panel are explained in the “ISPF Libraries and Data Sets” chapter of the *z/OS ISPF User’s Guide Vol I* except List ID, which is explained in “List data sets” on page 327, “Additional input libraries”, which is explained in “Input data sets” on page 326, and here:

Object

ISPF does not automatically generate any options for VS FORTRAN. Instead of generating an object module automatically, the VS FORTRAN compiler allows you to decide whether to generate one. To generate an object module, enter OBJECT in the Object field. To avoid generating an object module, enter NOOBJECT. See “Object data sets” on page 328 for more information.

Other If you plan to run FORTRAN interactive debug after you compile your program, enter TEST in the Other field, along with any other options you need.

PL/I (option 4.5)

The Foreground PL/I option enables you to invoke either OS PL/I Version 2 or PL/I for MVS and VM, using the values specified on the Foreground PL/I Compile panel shown in Figure 189 on page 333.

Menu	RefList	Utilities	Help
Foreground PL/I Compile			
			More: +
ISPF Library:			
Project . . .	MYPROJ		
Group	DEV
Type			
Member . . .		(Blank or pattern for member selection list)	
Other Partitioned or Sequential Data Set:			
Data Set Name . .			
List ID		Compiler	
Password . .		1. OS PL/I Version 2	2. PLI for MVS and VM
Compiler options: (options LIB, OBJECT, and PRINT generated automatically)			
====>			
Additional input libraries:			
====>			
====>			
Command =====>			
F1=Help	F2=Split	F3=Exit	F7=Backward F8=Forward F9=Swap
F10=Actions	F12=Cancel		

Figure 189. Foreground PL/I Optimizing Compile panel (ISRFP05)

All the fields on this panel are explained in the “ISPF Libraries and Data Sets” chapter of the *z/OS ISPF User’s Guide Vol I* except List ID, which is explained in “List data sets” on page 327, “Additional input libraries”, which is explained in “Input data sets” on page 326, and here:

Compiler

Choose the compiler you want to use from the list presented.

Compiler Options

Enter any options you need in the Other field, except LIB, OBJECT, or PRINT. ISPF generates these options automatically. LIB specifies the input data set concatenation sequence. OBJECT writes the output object module to a partitioned data set. PRINT writes the output listing to a list data set. See “Input data sets” on page 326, “Object data sets” on page 328, and “List data sets” on page 327 for more information.

VS Pascal compile (option 4.6)

The Foreground VS Pascal Compile panel is shown in Figure 190 on page 334.

Foreground—VS Pascal compile (option 4.6)

```
Menu  RefList  Utilities  Help
-----
                          Foreground VS PASCAL Compile
                                          More:  +

ISPF Library:
Project . . . MYPROJ
Group . . . DEV . . . . .
Type . . . .
Member . . . . (Blank or pattern for member selection list)

Other Partitioned or Sequential Data Set:
Data Set Name . . . . .

List ID . . . . . Password . . . . .

Compiler options: (options LIB, OBJECT, and PRINT generated automatically)
===> . . . . .

Additional input libraries:
===> . . . . .
===> . . . . .

Command ===> . . . . .
F1=Help      F2=Split      F3=Exit      F7=Backward  F8=Forward  F9=Swap
F10=Actions  F12=Cancel
```

Figure 190. Foreground VS Pascal Compile panel (ISRFP06)

All the fields on this panel are explained in the “ISPF Libraries and Data Sets” chapter of the *z/OS ISPF User’s Guide Vol I* except List ID, which is explained in “List data sets” on page 327, “Additional input libraries”, which is explained in “Input data sets” on page 326, and here:

Other Enter any options you need in the Other field, except LIB, OBJECT, or PRINT. ISPF generates these options automatically. LIB specifies the input data set concatenation sequence. OBJECT writes the output object module to a partitioned data set. PRINT writes the output listing to a list data set. See “Input data sets” on page 326, “Object data sets” on page 328, and “List data sets” on page 327 for more information.

Binder/linkage editor (option 4.7)

The Foreground Binder/Linkage Editor is called from the Foreground Binder/Linkage Edit panel, shown in Figure 191 on page 335.

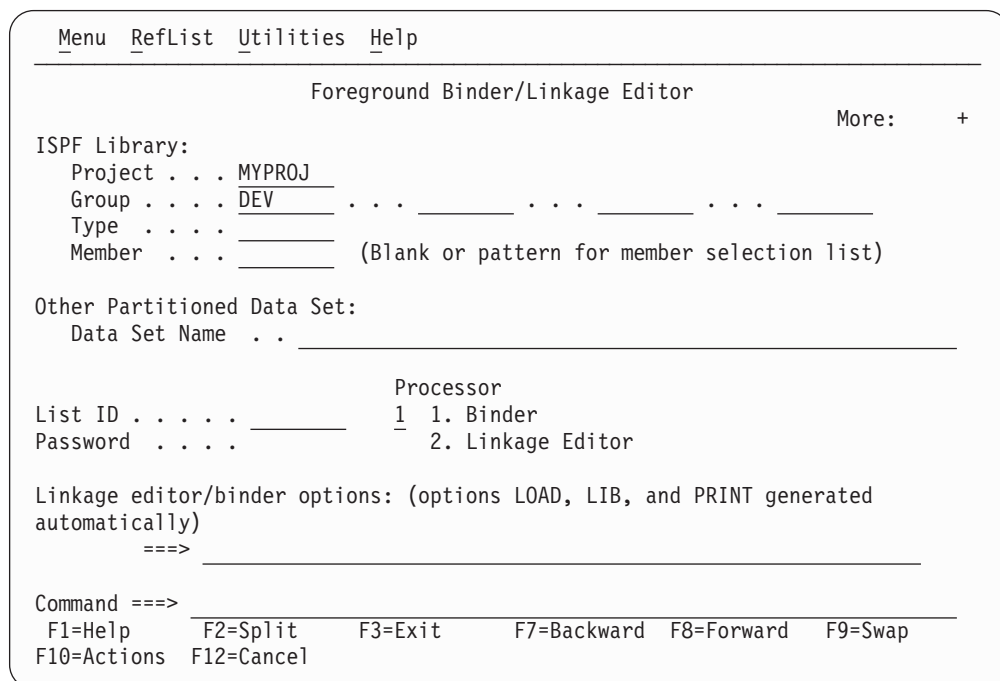

Figure 191. Foreground Binder/Linkage Editor panel (ISRF07B)

All the fields on this panel are explained in the “ISPF Libraries and Data Sets” chapter of the *z/OS ISPF User’s Guide Vol I* except List ID, which is explained in “List data sets” on page 327, “Additional input libraries”, which is explained in “Input data sets” on page 326, and here:

Linkage editor/binder options

Enter any options you need, except LOAD, LIB, or PRINT. ISPF generates these options automatically. LOAD writes the output object module to a partitioned data set.

Note: Sequential data sets are invalid when using the Linkage Editor.

LIB specifies the input data set concatenation sequence. PRINT writes the output listing to a list data set. See “List data sets” on page 327 and “Object data sets” on page 328 for more information.

Binder

Determines whether the Linkage Editor (NOBINDER) or Binder (BINDER) is invoked.

Note: The binder is available only if DFSMS 1.1, or later, is installed.

SYSLIB

The name of the data set that is to contain the ISPF library concatenation sequence used to resolve any copy statements specified in your program. See “Input data sets” on page 326 and the SYSLIB Data Set section in the topic about Allocation Data Sets in the *z/OS ISPF User’s Guide Vol I* for more information.

SYSLIN

The name of the data set that is to contain the object module. The SYSLIN field is provided to accommodate the VS Pascal XA and NOXA processing options. See “Input data sets” on page 326 and the SYSLIB Data Set section in the topic about Allocation Data Sets in the *z/OS ISPF User’s Guide Vol I* for more information.

Linkage editor concatenation sequence

The concatenation sequence used by ISPF to find the member for input to the Linkage Editor is:

```
project-name.lib1-name.type  
project-name.lib2-name.type  
(and so forth)
```

where type is whatever you specify on the panel. For example, it can be OBJ or some other type containing Linkage Editor language (LEL) control statements. If the type is not OBJ, an OBJECT DDNAME is automatically allocated to ease the use of these Linkage Editor control statements:

```
INCLUDE OBJECT(member-name)
```

For example:

```
Project . . . XYZ  
Group . . . MYLIB . . . MASTER . . .  
Type . . . LEL  
Member . . . TOP
```

In this example, ISPF searches data sets XYZ.MYLIB.LEL and XYZ.MASTER.LEL to find member TOP, which should contain LEL control statements. Also, ISPF allocates to DDNAME OBJECT (DISP=SHR) these concatenated sequence of object libraries:

```
XYZ.MYLIB.OBJ  
XYZ.MASTER.OBJ
```

This concatenated sequence is searched by the Linkage Editor if member TOP contains INCLUDE OBJECT(member-name) statements. The concatenation sequence passed to the Linkage Editor by way of the LIB parameter has a type qualifier of LOAD and includes the system libraries you specify, as follows:

```
LIB('project-name.lib1-name.LOAD',  
    'project-name.lib2-name.LOAD',  
:  
    and so forth,  
:  
    'syslib1-name',  
:  
    and so forth)
```

This concatenation sequence is used by the Linkage Editor to resolve automatic call references.

SCRIPT/VS processor (option 4.9)

Use of this facility requires the installation of the Document Composition Facility (DCF) program product and its component text processing program, SCRIPT/VS, with the Foreground Environment Feature.

Note: DCF requires the TSO profile prefix to be set. For additional information, refer to DCF documentation.

When you select the SCRIPT/VS option, the first panel displayed is the SCRIPT/VS Processor panel shown in Figure 192 on page 337.

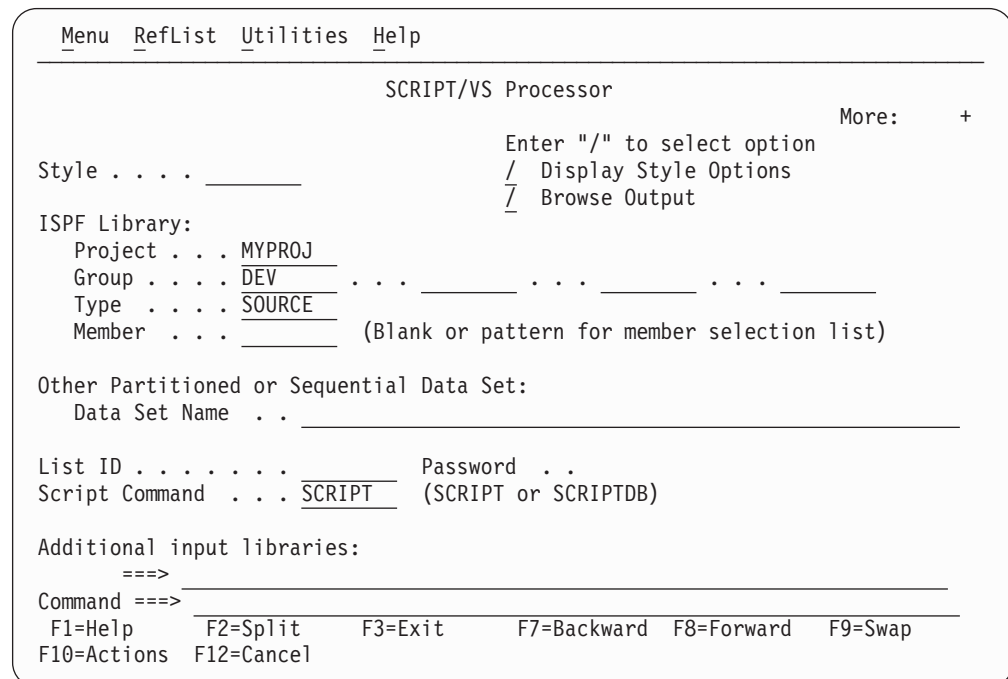

Figure 192. SCRIPT/VS Processor panel (ISRFP09)

All the fields on this panel are explained in the “ISPF Libraries and Data Sets” chapter of the *z/OS ISPF User’s Guide Vol I* except List ID, which is explained in “List data sets” on page 327, and Style, Display Style Options, and the Browse Output option, which are explained in subsequent sections.

SCRIPT/VS processing sequence

A *style* contains options that tell SCRIPT/VS how to format a document for display or printing. These options include the use of fonts, white space, line lengths, and so forth.

The value you put in the Style field and whether or not you select the Display Style Options and Browse Output options determine this SCRIPT/VS processing sequence:

1. For the Style field, you can perform one of these actions:

- Enter the name of an existing style.
 You can enter the name of a style you have created or one of the styles SCRIPT/VS creates for you: DRAFT and FINAL. These two styles correspond to the formatting options available in the previous release of SCRIPT/VS Foreground Processing. If you have not defined these options before or if this is your first release of ISPF, the default values for the SCRIPT/VS formatting options are set for you.
 If you enter the name of an existing style in the Style field, that style is used for formatting.
- Enter the name of a new style you want to define.
 If you enter a new style name, the name is added to your style list. The new style uses SCRIPT/VS formatting options that are equal to the formatting options of the last style. Step 2 on page 338 explains what to do to change these options.
- Leave the Style field blank.

Foreground—SCRIPT/VS processor (option 4.9)

If you leave the Style field blank, ISPF displays the Select SCRIPT/VS Formatting Style panel. This panel displays a list of the available styles. See “Selecting a formatting style” on page 340 for more information.

2. Use a slash to select Display Style Options. ISPF displays the SCRIPT/VS Options for Style panel, which shows the options that are currently being used and allows you to change them. See “Changing style options” on page 341 for more information.

If you do not select Display Style Options, ISPF does not display the SCRIPT/VS Options for Style panel.

3. Enter the appropriate ISPF library and concatenation sequence or data set names. You can display a member list by omitting the member name or by using a pattern. See the “ISPF Libraries and Data Sets” chapter of the *z/OS ISPF User’s Guide Vol I* if you need help entering library or data set names, “Input data sets” on page 326 for more information about the concatenation sequence, and the Displaying Member Lists section of the “ISPF Libraries and Data Sets” chapter of the *z/OS ISPF User’s Guide Vol I* for more information about displaying member lists.
4. Enter your password in the Password field if your input data set is password-protected. See “Password protection” on page 328 for more information.
5. Use the List ID field to tell ISPF what to name the output SCRIPT/VS listing. See “List data sets” on page 327 for more information.
6. Use a slash to select the Browse Output option. ISPF displays your output in Browse mode after it has formatted.

If you do not select the Browse Output option, ISPF skips Browse mode and displays a Foreground Print Options for Style panel, shown in Figure 193 on page 339.

7. Once all the input parameters have been specified, press Enter to call SCRIPT/VS.
8. Communication with SCRIPT/VS is in line-I/O mode. Each time you see three asterisks, press Enter. These asterisks, which usually appear at the bottom of the screen, show that TSO is waiting for you to clear the screen before it can proceed.

If the Session Manager is installed and you selected the Session Manager mode option on the ISPF Settings panel, SCRIPT/VS and all PF and PA keys are under control of the Session Manager. When formatting is complete, you are prompted to enter a null line to return to ISPF control.

If the Session Manager is not called, the PA and function keys have their usual TSO-defined meanings; generally, the function keys are treated the same as Enter.

9. One or both of the panels listed may appear, depending on your treatment of the Style and Display Style Options fields. If both appear, they will be in this sequence:
 - a. Select SCRIPT/VS Formatting Style
 - b. SCRIPT/VS Options for Style

See “Selecting a formatting style” on page 340 and “Changing style options” on page 341 if you need information about using these panels. When you are finished with each panel, press Enter.

10. If SCRIPT/VS generated an output listing and you selected the Browse Output option, the output is displayed automatically in Browse mode. Otherwise, continue with the next step.

Note: If SCRIPT/VS formatting ends abnormally, ISPF displays a message in the upper-right corner of the screen and does not enter Browse mode. The list data set is retained, but the Foreground Print Options for Style panel (see step 11) is not displayed.

You can scroll the output up or down using the scroll commands. All the Browse commands are available to you. When you finish browsing the listing, enter the END command.

11. An optional print utility exit can be installed by your system programmer. If this exit is installed, it may cause SCRIPT/VS's response to differ from the descriptions here. See *z/OS ISPF Planning and Customizing* for more information about the print utility exit.

Another factor that can affect the performance of SCRIPT/VS is whether the TSO/E Information Center Facility is installed. If the TSO/E Information Center Facility is installed, your installation can optionally allow ISPF to display a panel for submitting the TSO/E Information Center Facility information with the print request. See Figure 196 on page 343 for an example of this panel and “Using the TSO/E information center facility” on page 187 for information about the fields on this panel.

If the TSO/E Information Center Facility is not installed, SCRIPT/VS displays the panel shown in Figure 193.

The Foreground Print Options for Style panel allows you to optionally print the formatted document and specify its disposition. On this panel, the Data Set Name field shows the name of the list data set that contains the SCRIPT/VS output. On the Command line, enter one of the options shown at the top of the panel.

```

                                Foreground Print Options for Style:

PK Print data set and keep          K Keep data set (without printing)
PD Print data set and delete        D Delete data set (without printing)

If END command is entered, data set is kept without printing.

Data Set Name :

Print mode . . . BATCH              (Batch or Local)

Batch SYSOUT class . . _____
Local Printer ID or
writer-name . . . _____      (For local printer)
Local SYSOUT class . . _____

Job statement information:          (Required for system printer)
===> _____
===> _____
===> _____
===> _____

Command ===>
F1=HELP      F2=      F3=END      F4=DATASETS  F5=FIND      F6=CHANGE
F9=SWAP      F10=LEFT  F11=RIGHT  F12=SUBMIT
    
```

Figure 193. Foreground Print Options for Style panel (ISRFP09P)

In the Print mode field, enter either of these commands:

- BATCH to submit your print request as a background job.

Foreground—SCRIPT/VS processor (option 4.9)

If you choose BATCH, specify a valid Batch SYSOUT class and job statement information. Specifying BATCH causes SCRIPT/VS to ignore the “Local Printer ID or writer-name” field and the “Local SYSOUT class” field. SCRIPT/VS list data sets are formatted DCB=RECFM=VBM. Unless the line count is altered, the formatted page length may exceed the JES line count and cause duplicate page ejects. Therefore, specify this job statement information to prevent JES line counting:

```
/*JOBPARM LINECT=0
```

- LOCAL to print the output on a local printer.

If you choose LOCAL, specify the “Local Printer ID or writer-name” of a local printer and optional “Local SYSOUT class”. Specifying LOCAL causes SCRIPT/VS to ignore the “Batch SYSOUT class” field. Job statement information is ignored.

Page spacing will probably vary from the expected format because of differences between 328x printers and 1403 or 3800 printers used as a formatting guide.

See “Hardcopy utility (option 3.6)” on page 184 if you need information about the “Print mode”, “Batch SYSOUT class”, “Local Printer ID or writer-name”, and “Local SYSOUT class” fields. For information about the “Job statement information” fields, see the “ISPF Libraries and Data Sets” chapter of the *z/OS ISPF User’s Guide Vol I*.

When you press Enter, the SCRIPT/VS Processor panel is displayed again. A message indicating completion of the process is displayed in the upper-right corner of the screen.

12. You can perform one of these actions:
 - Enter other parameters and call SCRIPT/VS again.
 - Enter the END command to return to the Foreground Selection panel and select another processor.
 - Enter the RETURN command to go to the ISPF Primary Option Menu.
 - Use the jump function (=) to choose any primary option.

Selecting a formatting style

Use the Select SCRIPT/VS Formatting Style panel shown in Figure 194 on page 341 to see which styles are available and to select or delete styles as necessary.

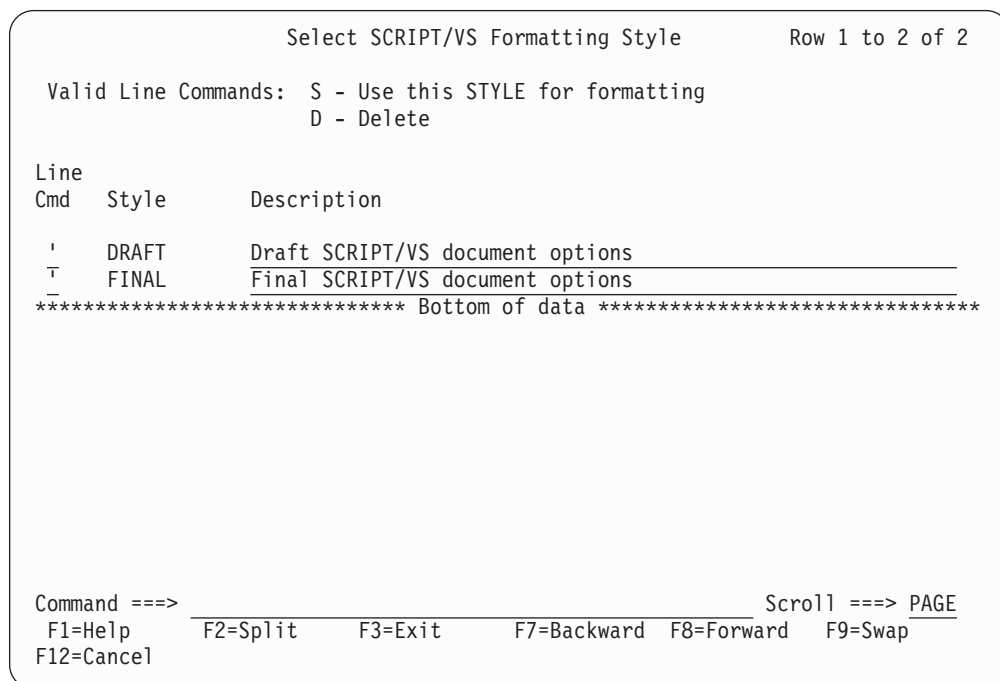

Figure 194. Select SCRIPT/VS Formatting Style panel (ISRFP09T)

The Select SCRIPT/VS Formatting Style panel is a list that can be scrolled and contains all the styles available to you. Each style is a set of predefined formatting options.

Type either S or D in the Line Cmd field and press Enter to select or delete a style, respectively. You can only select one style at a time for formatting. However, one or more styles can be deleted at the same time.

The display fields on the Select SCRIPT/VS Formatting Style panel contain:

Style The names of styles that you can either select or delete.

Description

A reminder of the purpose of each style. Type over the description to change it.

Changing style options

Use the SCRIPT/VS Options for Style panel to:

- See which options are currently being used for the style you chose
- Change the options as needed.

Figure 195 on page 342 shows the options available for the DRAFT style.

Foreground—SCRIPT/VS processor (option 4.9)

```
SCRIPT/VS Options for Style: DRAFT                                     More:  +
Profile data set . . _____
FONTLIB data set . . _____
SEGLIB data set . . . _____
User macro data set . . . _____
System macro data set . . _____

Bind:      #Odd . . _____
          #Even . . _____

Device type . . . . . _____
Chars (Fonts) . . . . . _____
SYSVAR . . . . . _____
Page . . . . . _____

Other script parms . . . _____

Enter "/" to select option
  / Twopass                               / Uppercase only
  / Spelling                              / Unformat
  / Index                                 / Condensed Text
  / Command ==>
F1=Help  F2=Split  F3=Exit  F9=Swap  F12=Cancel
```

Figure 195. SCRIPT/VS Options for Style: DRAFT panel (ISRFP090)

The fields on the SCRIPT/VS Options for Style panel represent SCRIPT/VS formatting options, all of which are optional. For a complete description of these options, refer to *Document Composition Facility: Generalized Markup Language Starter Set User's Guide*.

If you enter the END command from the SCRIPT/VS Options for Style panel, changes on this panel are not saved. If the style is new, it is saved with default formatting options.

If you press Enter from the SCRIPT/VS Options for Style panel, SCRIPT/VS processes the data set, and then one of these actions occurs:

- A Browse panel is displayed if you selected the Browse Output option on the SCRIPT/VS Processor panel. When you finish browsing the SCRIPT/VS formatted output, a Foreground Print Options for Style panel is displayed.

Note: If you enter the PRINT parameter in the "Other script parms" field, the Browse panel is not displayed.

- A Foreground Print Options for Style panel is displayed if you did not select the Browse Output option on the Script/VS Processor panel.

See step 11 on page 339 for more information about printing SCRIPT/VS output.

Using SCRIPT/VS with the TSO/E information center facility

If the TSO/E Information Center Facility is installed, your installation can optionally allow ISPF to substitute the panel shown in Figure 196 on page 343 for the panel shown in Figure 193 on page 339. See "Using the TSO/E information center facility" on page 187 for information about the fields on this panel.

```

                                Foreground Print Options for Style:

PK Print data set and keep          K Keep data set (without printing)
PD Print data set and delete        D Delete data set (without printing)

If END command is entered, data set is kept without printing.

Data Set Name . . . :
Printer location . . _____
Printer Format . . . _____
Number of copies . . ____

Command ==>
F1=HELP      F2=          F3=END      F4=DATASETS  F5=FIND      F6=CHANGE
F9=SWAP      F10=LEFT     F11=RIGHT  F12=SUBMIT
    
```

Figure 196. Foreground Print Options for Style panel with the TSO/E information center facility (ISRFPO9I)

VS COBOL II interactive debug (option 4.10)

To run VS COBOL II interactive debug in foreground, the VS COBOL II compiler, Release 2, must be both installed and accessible, for these reasons:

- You must compile your program by using the VS COBOL II compiler (option 4.2 or option 5.2) with the TEST and RESIDENT options before running VS COBOL II interactive debug. Debug output from the compilation is stored in the object module, which ISPF generates automatically.
- The VS COBOL II compiler contains the Debug Productivity Aid (DPA) facility, which ISPF accesses when you run VS COBOL II interactive debug in the foreground.

All VS COBOL II interactive debug processing in the foreground is under DPA's control. DPA displays a series of interactive panels. When processing is complete, return to step 12 on page 321.

OS/VS COBOL debug (option 4.10A)

Before you can run COBOL interactive debug, you must first perform these actions in the order shown:

1. Allocate a symbolic debug data set and, optionally, a print output data set by using the Data Set utility (option 3.2). See "Symbolic debug data sets" on page 345 and "Print output data sets" on page 345 for more information.
2. Compile the program by using the OS/VS COBOL compiler (option 4.2A or option 5.2A) with the TEST option.
3. Use the linkage editor (option 4.7 or option 5.7) to generate an output load module, which COBOL interactive debug will use as input.

The COBOL Debug panel is shown in Figure 197 on page 344.

```

Menu  RefList  Utilities  Help
-----
                                COBOL Interactive Debug
                                More:      +

ISPF Library:
Project . . . _____
Group . . . . _____ (Type = LOAD assumed)
Member . . . _____ (Blank or pattern for member selection list)

Other Partitioned or Sequential Data Set:
Data Set Name . . _____

Prog ID . . . . . _____ . . . _____ . . . _____ . . . _____

Print ID . . . . . _____ Password . .

Enter "/" to select option
/ Source

Execution Parms:
====> _____
Additional input libraries:
====> _____
====> _____
====> _____

Note: 1. PREFIX.PRINTID.TESTLIST must exist if Print ID is specified.
      2. PREFIX.PROGID.LIST must exist for each program specified if / is
         specified in Source field.

Command ====>
F1=HELP      F2=      F3=END      F4=DATASETS  F5=FIND      F6=CHANGE
F9=SWAP      F10=LEFT   F11=RIGHT   F12=SUBMIT
    
```

Figure 197. COBOL Debug panel (ISRFP10A)

All the fields on this panel are explained in the “ISPF Libraries and Data Sets” chapter of the *z/OS ISPF User’s Guide Vol I*, except Prog ID, Print ID, Source, and Execution Parms, which are explained in subsequent topics.

COBOL debug processing sequence

Fill in the fields on the COBOL Debug panel as follows:

1. Enter the ISPF library or data set name that contains the input load module generated by the linkage editor. You can display a member list by omitting the member name or by using a pattern. See the “ISPF Libraries and Data Sets” chapter of the *z/OS ISPF User’s Guide Vol I* if you need help entering library or data set names, “Object data sets” on page 328 for more information about object modules, and the Displaying Member Lists section of the “ISPF Libraries and Data Sets” chapter of the *z/OS ISPF User’s Guide Vol I* for more information about displaying member lists.
2. The Prog ID field tells ISPF the names of the sequential list data sets generated by the OS/VS COBOL compiler. You can enter up to four Prog ID names if you compiled a partitioned data set member or a sequential data set for each name. See “List data sets” on page 327 for more information.
3. The Print ID field is optional. This field tells ISPF the name of a sequential data set to which it writes the print output from the debug session. This data set must be preallocated. See “Print output data sets” on page 345 for more information.

4. Enter your password in the Password field if your input data set is password-protected. See “Password protection” on page 328 for more information.
5. The Source option tells ISPF whether to allocate the list data sets specified in the Prog ID field. If you select Source, these data sets must already exist.
6. The ExecutionParms field is remembered from one session to another. Therefore, you do not need to change this field unless the parameters you need are not displayed. Enter any parameters that you want ISPF to pass to the program being debugged.
7. To continue COBOL interactive debug, return to step 12 on page 321.

Symbolic debug data sets

If you want to run COBOL interactive debug on a program compiled with the OS/VS COBOL compiler, you must use the Data Set utility (option 3.2) to allocate a symbolic debug data set before compiling the program. Then, when you compile the program, enter TEST in the Test field on the Foreground OS/VS COBOL Compile panel. The TEST parameter generates the debug output, which ISPF stores in the symbolic debug data set you allocated.

Note: You do not need to allocate a symbolic debug data set for programs compiled with VS COBOL II because the debug output, if requested, is stored in the OBJECT module, which ISPF generates automatically.

When you allocate the data set, specify the same name as the data set that contains your COBOL program, but:

- For an ISPF library, enter:
 - The Group name you will specify in the first Group field on the Foreground OS/VS COBOL Compile panel
 - SYM in the Type field.
- For another partitioned or sequential data set, use SYM to replace the last qualifier. For example, if COBOL.INPUT or COBOL is the input data set name, allocate COBOL.SYM as the symbolic debug data set.

Use these values to allocate symbolic debug data sets:

```
Record format . . . . . F
Record length . . . . . 512
Block size . . . . . 512
```

For partitioned data sets, including ISPF libraries, the debug output is stored in a member with the same name as the input member. For sequential data sets, the debug output is stored in a sequential data set.

When you run COBOL interactive debug, the names you put in the Prog ID field on the COBOL Interactive Debug panel must be the same as the input member names if you are to create a correct SYM data set.

Print output data sets

ISPF writes the print output from a debug session to a sequential data set, if you:

- Allocate the data set, using the Data Set utility (option 3.2), before you run COBOL interactive debug
- Enter, in the Print ID field on the COBOL Interactive Debug panel, the name of the data set you allocated.

Foreground—OS/VS COBOL Debug (option 4.10A)

You can avoid generating the print output by leaving the Print ID field blank, even if you allocated the data set.

The last qualifier in the name of the data set you allocate must be TESTLIST. For example, if you allocate a sequential data set named DEBUG1.TESTLIST and then specify the Print ID as:

```
Print ID . . DEBUG1
```

ISPF writes the print output to a sequential data set named:

```
'prefix.userid.DEBUG1.TESTLIST'
```

where *prefix* is your TSO data set prefix, if you have one and if it is different from your user ID, and *userid* is your TSO user ID. Use these values to allocate print output data sets:

```
Record format . . . . . FBA  
Record length . . . . . 121  
Block size . . . . . 3146
```

The value you put in the Block Size field should be a multiple of 121, the record length. Therefore, if your print output data is too large to fit within the recommended block size (3146), increase this amount by using a multiple of 121, such as 3267 or 3388.

FORTRAN debug (option 4.11)

Before you can run FORTRAN interactive debug, you must first compile the program using the VS FORTRAN compiler (option 4.3 or option 5.3) with the OBJECT and TEST options.

The FORTRAN interactive debug option supports both FORTRAN Interactive Debug Version 2 (5668-903) and FORTRAN Interactive Debug Version 1 (5734-F05). ISPF looks for Version 2 first, then Version 1, and finally its own Debug Dialog, which displays the panel shown in Figure 198 on page 347.

```

Menu  RefList  Utilities  Help
-----
                                FORTRAN Interactive Debug
                                More:      +

ISPF Library:
Project . . . _____
Group . . . . . _____ . . . . . _____ . . . . . _____
Type . . . . . OBJ      (OBJ or LOAD)
Member . . . _____ (Blank or pattern for member selection list)

Source Type . . _____

Other Partitioned or Sequential Data Set:
Data Set Name . . _____

List ID . . . . . _____ Password . .

Debug Options: (options LIB, SOURCE, and PRINT generated automatically)
====> _____

Additional input libraries:
====> _____
====> _____
====> _____
Command ====> _____
F1=Help      F2=Split      F3=Exit      F7=Backward  F8=Forward  F9=Swap
F10=Actions  F12=Cancel

```

Figure 198. FORTRAN Debug panel (ISRFP11)

All the fields on this panel are explained in the “ISPF Libraries and Data Sets” chapter of the *z/OS ISPF User’s Guide Vol I* except List ID, which is explained in “List data sets” on page 327, “Additional input libraries”, which is explained in “Input data sets” on page 326, and here:

Debug Options

Enter any options you need, except LIB, SOURCE, or PRINT. ISPF generates these options automatically. LIB specifies the input data set concatenation sequence. SOURCE specifies the input source program, whose type is identified in the Source Type field. PRINT writes the output listing to a list data set. See “Input data sets” on page 326 and “List data sets” on page 327 for more information.

Member parts list (option 4.12)

The member parts list uses the program ISRLEMX to show this information for each source program module specified:

- The names of the modules it calls or includes.
- The names of the modules that call or include it.

The languages permitted in the member expansion function also are permitted in the member parts list function, and the expansion triggers have the same restrictions. See “Member expansion (ISRLEMX)” on page 324. Besides the expansion triggers, the member parts list also uses the CALL statements in assembler, PL/I, COBOL, and VS FORTRAN. The format of the CALL statement is:

```
CALL name
```

where the delimiter after the name can be either a left parenthesis, a blank, or a valid statement delimiter. In COBOL, the CALL statement is valid only in the

Foreground—member parts list (option 4.12)

PROCEDURE DIVISION, and the CALL PGMA and CALL 'PGMA' statements both result in a reference to the member name PGMA.

When you select the Foreground Member parts list option (4.12), the panel shown in Figure 199 is displayed.

```
Menu  RefList  Utilities  Help
-----
                          Foreground Member Parts List

1 Browse/Print member parts
2 Write member parts data set

ISPF Library:
  Project . . . _____
  Group . . . . _____ . . . . _____ . . . . _____
  Type . . . . _____
  Member . . . _____ (Blank or pattern for member selection list)

Language . . . . _____ (Defaults to Type value)

Groups for Primary members . . . 1 (1, 2, 3, or 4)

Output Data Set:          (option 2 only)
  Data Set Name . . _____

Option ==>
F1=Help   F2=Split   F3=Exit   F7=Backward F8=Forward F9=Swap
F10=Actions F12=Cancel
```

Figure 199. Foreground Member Parts List panel (ISRFP12)

The member parts list does not use the Source Data Packed option on the Foreground Selection panel; both packed and unpacked data sets can be read.

Fill in the fields on the Foreground Member Parts List panel as follows:

1. Select one of the options listed at the top of the panel by typing its number in the Option field.
2. Enter the appropriate ISPF library and concatenation sequence or data set names. A blank member name results in a member list being displayed. You can select only one member from this list. A pattern results in the processing of all member names matching the pattern; an asterisk results in all members being processed.

See the “ISPF Libraries and Data Sets” chapter of the *z/OS ISPF User’s Guide Vol I* if you need help entering library or data set names, the Displaying Member Lists section of the “ISPF Libraries and Data Sets” chapter of the *z/OS ISPF User’s Guide Vol I* for information about using patterns and displaying member lists, and “Input data sets” on page 326 for more information about the concatenation sequence.

3. The Language field is optional. It is used to specify the language in which the source code is written. If you leave this field blank, ISPF uses the value in the Type field as the default. However, the language must be one of these:
 - Assembler
 - COBOL
 - FORTRAN
 - Pascal
 - PLI

- SCRIPT.
4. In the “Groups For Primary members” field, enter a number from 1 to 4. This number tells ISPF how many libraries in the concatenation sequence are to be used in locating primary members. For example, if you enter 2, the first and second libraries specified in the Group field are used to find primary members.
 5. If you selected option 2 (write member parts data set), use the Data Set Name field to tell ISPF where to write the output data set. The name you enter:
 - Can be a sequential data set or a member of a partitioned data set
 - Must follow standard TSO data set naming conventions.If you enter the name of a data set that does not exist, ISPF allocates it for you.
 6. Once all the input parameters have been specified, press Enter to call the Foreground Member Parts List processor.

If the Session Manager is installed and if you specified Session Manager mode on the Foreground Selection panel, the Foreground Member Parts List processor and all function keys and PA keys are under control of the Session Manager. When processing is complete, you are prompted to enter a null line to return to ISPF control.

If the Session Manager is not called, the PA and function keys have their usual TSO-defined meanings; generally, the function keys are treated the same as Enter.
 7. Communication with the Foreground Member Parts List processor is in line-I/O mode. Each time you see three asterisks, press Enter. These asterisks, which usually appear at the bottom of the screen, show that TSO is waiting for you to clear the screen before it can proceed.
 8. The option you chose in step 1 on page 348 determines what happens next.

Note: If the Foreground Member Parts List processing program ends abnormally, ISPF displays a message in the upper-right corner of the screen and does not enter Browse mode. The list data set is retained, but the Foreground Print Options panel (see step 15 on page 322) is not displayed.

Option 1 (Browse/print member parts) creates the member parts list and displays it in Browse mode. This figure shows an example.

Foreground—member parts list (option 4.12)

```

BROWSE - Parts List for ISPFPROJ.ABL.PLI(*) -----
  From Via      From Via      Member      To Via      To Via
  ---- --      - - - - -      - - - - -      - - - - -      - - - - -
***** Top of Data *****
                (MEMBERA )
                (MEMBERB ) MEMBERC C
                MEMBERB C      (MEMBERC ) MEMBERD C      MEMBERE I
                MEMBERC C      (MEMBERD ) MEMBERE I
MEMBERC I      MEMBERD I      (MEMBERE )
                (MEMBERF )
***** Bottom of Data *****

Command ==>
F1=Help  F2=Split  F3=Exit  F5=Rfind  F7=Up    F8=Down  F9=Swap
F10=Left F11=Right F12=Cancel
    
```

Figure 200. Member parts list display (ISRF12B)

The figure shows that:

- Library ISPFPROJ.ABL.PLI contains these members:

MEMBERA

Has no calls or includes.

MEMBERB

Calls MEMBERC.

MEMBERC

Calls MEMBERD and MEMBERG, and includes MEMBERE. The asterisk (*) beside the C in the third VIA column means that MEMBERG was not found in the input library.

MEMBERD

Includes MEMBERE.

MEMBERE

Has no calls or includes.

MEMBERF

Has no calls or includes.

- A parts list is requested for all members in the first data set.

You can scroll the output up or down using the scroll commands. All the Browse commands are available to you. When you finish browsing the listing, enter the END command and continue with step 15 on page 322.

Option 2 (Write member parts data set) produces an intermediate sequential member parts list in the data set you named in step 5 on page 349. This data set can be either a sequential data set or a member of a partitioned data set.

If the data set has not been allocated, option 2 allocates it with a logical record length (LRECL) of 17, a block size (BLKSIZE) of 3009, and a record format (RECFM) of FB. The format of the records is shown in Table 20 on page 351:

Table 20. Foreground member parts list record formats

Field Name	Format	Description
Member name	CHAR(8)	Subject member.
Called by or calls member name	CHAR(8)	Referenced member.
Call flag	BIT(1)	Found on a CALL statement.
Include flag	BIT(1)	Found by INCLUDE or COPY.
Not found flag	BIT(1)	Referenced member not found.
From flag	BIT(1)	Subject member called from referenced member.
To flag	BIT(1)	Referenced member called from subject member.
COBOL flag	BIT(1)	Member referenced outside valid COBOL division.
Reserved	BIT(2)	Field that is reserved.

9. You can perform one of these actions:
 - Enter other parameters and call the same processor.
 - Enter the END command to return to the Foreground Selection panel and select another processor.
 - Enter the RETURN command to go to the ISPF Primary Option Menu.
 - Use the jump function (=) to choose any primary option.

Member not found

A *primary library* is one of the number of libraries specified in the “Groups For Primary members” field. A *primary member* is a member that starts the member parts explosion chain. An *explosion chain* is the order in which members are nested, starting with the primary member and continuing through each member that it includes, calls, or copies.

The chain is broken when a member cannot be found in the set of concatenated libraries or no more members are referenced. If a member cannot be found, the name is flagged with an asterisk (*) and processing continues. For instance, internally called routines are not found.

When no more primary members can be found, the listing is printed, written, or browsed. Calls to internal routines or variable names result in the member not found flag being set.

C/370 compile (option 4.13)

ISPF supports the C/370™ compiler through dialogs supplied with the C/370 compiler (5688-040). See *C Compiler User’s Guide for MVS*, SC09-1129 for additional information.

REXX/370 compile (option 4.14)

ISPF supports the REXX/370 compiler through dialogs supplied with the REXX/370 compiler (5695-013). See *IBM Compiler and Library for REXX/370 User’s Guide and Reference*, SH19-8160, for additional information.

Ada/370 compile (option 4.15)

ISPF supports the Ada/370 compiler and its tools through dialogs supplied with the Ada/370 compiler (5706-292). See *IBM Ada/370 User's Guide* SC09-1415, for additional information.

AD/Cycle C/370 compile (option 4.16)

ISPF supports the AD/Cycle C/370 compiler through dialogs supplied with the AD/Cycle C/370 compiler (5688-216). See *IBM SAA AD/Cycle C/370 Programming Guide* SC09-1356, for additional information.

ISPDTLC (option 4.18)

ISPF supports the ISPF Dialog Tag Language compiler by running the ISPDTLC function. See *z/OS ISPF Dialog Tag Language Guide and Reference* for more information about DTL.

The first ISPDTLC interface panel appears as shown in this figure.

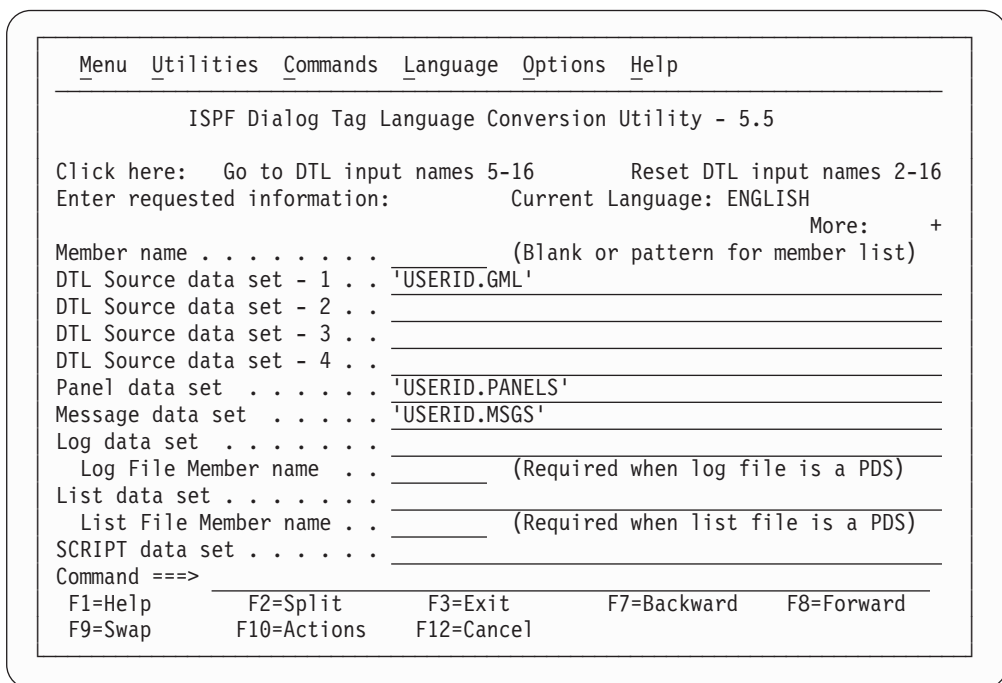

Figure 201. Foreground ISPDTLC compile panel (ISPCP01) Screen 1

The fields on this panel are explained in the topic “Using the Conversion Utility” in *z/OS ISPF Dialog Tag Language Guide and Reference*.

OS/390 C/C++ compile (option 4.19)

ISPF supports the OS/390® C/C++ compiler and its tools through dialogs supplied with the OS/390 C/C++ compiler (5647-A01). For information about OS/390 C/C++, refer to the *OS/390 C/C++ User's Guide*.

Chapter 7. Batch (option 5)

The Batch option (5) allows ISPF to run the batch processors shown on the Batch Selection panel, Figure 202, as batch jobs. ISPF generates job control language (JCL) for the job, based on information you enter on the batch processing panels, and then submits the job for processing. All these processors, plus SCRIPT/VS, COBOL interactive debug, and FORTRAN interactive debug, are also available with the Foreground option (4).

When you run a batch processor, you can continue using ISPF while the program is running. However, if you run these processors by using the Foreground option, you must wait for processing to end before doing anything else with ISPF. The Foreground Selection panel is shown in Figure 183 on page 319.

```
Menu  Utilities  Help
-----
                                Batch Selection Panel

1 Assembler                    7 *Binder/Link editor    15 *ADA/370
2 COBOL                        10 *VS COBOL II debug   16 *AD/Cycle C/370
3 VS FORTRAN                   12 Member Parts List    18 ISPTLC
5 PLI                          13 *C/370                19 *OS/390 C/C++
6 VS PASCAL                    14 *REXX/370

Enter "/" to select option          * No packed data support
/ Source data online
_ Source data packed

Job Statement Information: Verify before proceeding

====> //LSACKV1 JOB (ACCT),CLASS=A
====> //*
====> //*
====> //*

Option ====>
F1=Help    F2=Split    F3=Exit    F7=Backward  F8=Forward  F9=Swap
F10=Actions F12=Cancel
```

Figure 202. Batch Selection panel (ISRJPA)

The names of the batch processors on this panel are point-and-shoot fields. See the information about Point-and-Shoot Text Fields in the ISPF User Interface topic in the *z/OS ISPF User's Guide Vol I* for more information.

Batch selection panel action bar

The Batch Selection Panel action bar choices function as follows:

Menu See the information about the Menu Action Bar Choice in the ISPF User Interface topic in the *z/OS ISPF User's Guide Vol I* for more information about the Menu pull-down.

Utilities

See the information about the Utilities Action Bar Choice in the ISPF User Interface topic in the *z/OS ISPF User's Guide Vol I* for more information about the Utilities pull-down.

Batch (option 5)

Help The Help pull-down provides general information about foreground processing as well as information about each available choice on the Batch Selection Panel.

Batch processing sequence

This topic describes the main sequence for batch processing.

1. If you do not know whether the source data is in packed format, find out by editing the data set and entering the PROFILE command. If the source data is in packed format, the profile shows PACK ON.
If the data is not packed, continue with the next step.
If the data is packed, you should read “Expanding packed data” on page 323, paying close attention to information that applies to the batch processor you plan to use. When you are satisfied that the data set is ready to be processed, save the data set if you are in Edit and continue with the next step.
2. Select a batch processor. If you bypass the Batch Selection panel, you cannot verify or change the job statement parameters, or generate multiple compilations (multiple job steps) or link-edits within the same job.
3. Select the Source data online option to tell ISPF that the data to be processed resides on a currently mounted volume. ISPF checks the data set information that you entered on the Batch Selection panel and allows you to display a member list. If you do not select this option, ISPF assumes that the data cannot be accessed except by the batch job and does not verify the existence or validity of the specified data set.
4. Select the Source data packed option to tell ISPF that it needs to expand the source data. This option has no effect on the member parts list option (5.12). Member parts list can read both packed and unpacked data sets, so no expansion is needed.
5. Enter any job statement information you need. See the information about Job Statement Information in the “ISPF Libraries and Data Sets” chapter of the *z/OS ISPF User’s Guide Vol I* for more information.
6. Press Enter. ISPF displays the data entry panel for the processor you selected.

Note: The remainder of this processing sequence applies to all batch processors except Member Parts List. See “Member parts list (option 5.12)” on page 365 for more information.

7. Enter the appropriate ISPF library and concatenation sequence or data set names.

For VS COBOL II interactive debug, enter the name of the input object module or load module. The TYPE, or last qualifier, must be either OBJ or LOAD. However, if you specify an OBJ data set as your input data set, you must include a load library or data set in the input search sequence (see step 11 on page 355).

ISPF displays a member list if you omit the member name or use a pattern. See the information about Naming ISPF Libraries and Data Sets in the “ISPF Libraries and Data Sets” chapter of the *z/OS ISPF User’s Guide Vol I* if you need help entering library or data set names, “Input data sets” on page 326 for more information about the concatenation sequence, and the Displaying Member Lists section of the “ISPF Libraries and Data Sets” chapter of the *z/OS ISPF User’s Guide Vol I* for more information about displaying member lists.

Note:

- a. VS FORTRAN has no LIB option. However, the concatenation sequence is still used to find the member to be compiled.
- b. Password protection is not supported from the Batch option. Therefore, if your input or output data sets are password-protected, use the Foreground option, which does support passwords.

If you submit a job requiring a password-protected data set, the system operator will be requested to enter the required password.

8. The List ID field tells ISPF what to name the output listing. Leave this field blank and enter a SYSOUT class to send the listing to a printer. See “List data sets” on page 327 for more information.
9. Enter a SYSOUT class to generate hardcopy of the listing. You can enter any valid SYSOUT parameter. If a List ID is entered, this field is ignored.
10. The Options field, whether ASSEMBLER, COMPILER, or LINKAGE EDITOR, is remembered from one session to another. Therefore, you do not need to change these fields unless the options or parameters you need are not displayed.

If you need information about the options available for your processor, refer to the documentation provided with the processor.

11. Enter any additional input libraries you need. For VS COBOL II interactive debug, enter any input LOAD libraries that you need to complete the search. These libraries must be LOAD libraries only. See “Input data sets” on page 326 if you need help.
12. Once all the input fields have been specified, press Enter to call the batch processor. ISPF generates the appropriate JCL statements. See “JCL generation—compilers” on page 356 and “JCL generation—assemblers and linkage editor” on page 358 for more information.

Note: You can leave the entry panel without generating any JCL by entering the END command instead of pressing Enter.

13. One of these actions occurs:
 - If you used the jump function to bypass the Batch Selection panel, ISPF submits the generated JCL and returns directly to the ISPF Primary Option Menu.

ISPF calls the TSO SUBMIT command to submit a job. The SUBMIT command displays this message:

```
JOB useridA(JOB nnnnn) SUBMITTED
***
```

When you press Enter or any other interrupt key, ISPF returns to the previous panel.

- Otherwise, ISPF returns to the Batch Selection panel with the message Job step generated displayed in the short message area on line 1, as shown in Figure 203 on page 356.

Batch—processing sequence

```
Menu Utilities Help
-----
Batch Selection Panel                               Job step generated
                                                    More:      +
1 Assembler                7 *Binder/Link editor    15 *ADA/370
2 COBOL                    10 *VS COBOL II debug   16 *AD/Cycle C/370
3 VS FORTRAN               12 Member Parts List    18 ISPTLTC
5 PLI                      13 *C/370                19 *OS/390 C/C++
6 VS PASCAL                14 *REXX/370

Enter "/" to select option          * No packed data support
/ Source data online
_ Source data packed

Job Statement Information:

====> //LSACKV1 JOB (ACCT),CLASS=A
====> //*
====> //*
====> //*

Option ====>
F1=Help      F2=Split      F3=Exit      F7=Backward  F8=Forward  F9=Swap
F10=Actions  F12=Cancel
```

Figure 203. Batch Selection Panel with JCL generated (ISRJPB)

The job statement parameters are shown for information only. They are no longer intensified, and you cannot type over them because the JOB statement has already been generated. At this point, you can:

- Select the same or another processor to cause more JCL to be generated.
- Go to the ISPF Primary Option Menu by:
 - Canceling the batch job by entering the CANCEL command
 - Entering the END or RETURN command to cause the generated JCL to be submitted for processing.
- Use the jump function (=) to choose any primary option. If any JCL has been generated, it is submitted for batch processing.

JCL generation—compilers

Figure 207 on page 361 shows an example for the PL/I optimizing compiler. This panel is typical of the batch compiler entry panels. After you fill in an entry panel and press Enter, ISPF generates the appropriate JCL statements. The JCL that would be generated for the PL/I example is:

```
//SCAN EXEC PGM=ISRLEMX,COND=(12,LE),
// PARM=('PLI, TOPSEG,B,N,E,4, ,00,ENU,4,7',
// '1,/,VIO')
//*
/* INSERT STEPLIB DD CARDS HERE FOR ISRLEMX AND THE NATIONAL
/* LANGUAGE LITERAL LOAD MODULE IF THEY ARE NOT IN YOUR SYSTEM
/* LIBRARY
/*
//ISRLCODE DD DSN=ISPFDEMO.XXX.PLI0,DISP=SHR
// DD DSN=ISPFDEMO.A.PLI0,DISP=SHR
// DD DSN=ISPFDEMO.MASTER.PLI0,DISP=SHR
//ISRLEXPDD DD UNIT=SYSDA,DISP=(NEW,PASS),SPACE=(CYL,(2,2)),
// DSN=&&TEMP1
//ISRLMSG DD SYSOUT=(A)
//PLI0 EXEC PGM=IEL0AA,REGION=1024K,COND=(12,LE),
// PARM='MACRO,XREF'
```



```
//SYSPRINT DD DSN=ISPFDEMO.LISTPLIO.LIST,UNIT=SYSDA,
//          SPACE=(CYL,(2,2)),DISP=(MOD,CATLG),
//          DCB=(RECFM=VBA,LRECL=125,BLKSIZE=3129)
//SYSIN DD DSN=&&TEMP1,DISP=(OLD,DELETE)
//SYSLIB DD DSN=ISPFDEMO.XXX.PLIO,DISP=SHR
//          DD DSN=ISPFDEMO.A.PLIO,DISP=SHR
//          DD DSN=ISPFDEMO.MASTER.PLIO,DISP=SHR
//          DD DSN=ISPFTEST.FLAG.PLIO,DISP=SHR
//SYSUT1 DD UNIT=SYSDA,SPACE=(CYL,(2,2))
//SYSLIN DD DSN=ISPFDEMO.XXX.OBJ(TOPSEG),DISP=OLD\
```

The JCL is generated in two steps:

1. The first step processes one of these scan programs, which are distributed as part of ISPF:

ISRSCAN

Copies one member.

ISRLEMX

Copies the primary member, expands any included members, and unpacks any packed members.

The selected scan program searches the user-specified sequence of concatenated libraries to find the designated member. If the scan program finds the member, it copies the member to a temporary sequential data set that is shown by &&TEMP1 and generated by the system. The scan program then exits with a return code of zero, if no errors are found. If any errors are found, the scan program exits with one of these return codes, which prevents the processing of the second job step. Table 21 describes ISRLEMX return codes:

Table 21. *ISRSCAN and ISRLEMX return codes*

ISRSCAN		ISRLEMX	
12	Member not found.	1-15	Parameter <i>n</i> was too long, where <i>n</i> = 1 to 15.
16	OPEN error on DDNAME=IN.	16	Too many parameters.
20	I/O error on DDNAME=IN.	17	Too few parameters.
24	OPEN error on DDNAME=OUT.	20	Severe error in expand module. An error message should be printed in the ISRLMSG data set.
28	I/O error on DDNAME=OUT.		

2. In this example, the second step calls the PL/I optimizing compiler by using the temporary data set designated by &&TEMP1 as the input data set. The concatenation sequence is passed to the compiler through SYSLIB DD statements, to allow inclusion of subsidiary members referenced by %INCLUDE statements in the source text.

The object module is directed to a partitioned data set with a three-level name composed of the project name, the first library name, and a type qualifier of OBJ. The member name for the object module is the same as the primary member to be compiled.

The compiler listing is directed to SYSOUT class A, as specified.

JCL generation—assemblers and linkage editor

For batch assembly and link-edit, an optional SYSTERM DD statement is generated (if you specify TERM) besides the JCL shown in “JCL generation—compilers” on page 356, as follows:

```
//SYSTERM DD DSN=prefix.member.TERM,DISP=(MOD,CATLG)
```

where:

prefix The data set prefix in your TSO user profile

member

For members of partitioned data sets, this is the same member name specified on the entry panel. For sequential data sets, this name is TEMPNAME.

Assembler (option 5.1)

Batch Assembler enables you to invoke either High Level Assembler or Assembler H. Both are called from the Batch Assembler panel, shown in Figure 204. For information about Assembler allocation data sets, see the topic about Allocation Data Sets in the *z/OS ISPF User's Guide Vol I*.

```

Menu  RefList  Utilities  Help
-----
                                Batch Assembler                                More:  +
ISPF Library:
Project . . . . PDFTDEV
Group . . . . LSACKV . . . . _____ . . . . _____ . . . . _____
Type . . . . ASM
Member . . . . _____ (Blank or pattern for member selection list)

Other Partitioned or Sequential Data Set:
Data Set Name . . . _____

List ID . . . . _____ (Blank for hardcopy)  1 1. High Level Assembler
SYSOUT class . . . _____ (For hardcopy)    2 2. Assembler H

Assembler options:
Term . . . . _____ (TERM or NOTERM)
Other . . . . _____

Command ==>>>
F1=Help    F2=Split    F3=Exit    F7=Backward  F8=Forward  F9=Swap
F10=Actions F12=Cancel
    
```

Figure 204. Batch Assembler panel (ISRJP01)

All the fields on this panel are explained in the “ISPF Libraries and Data Sets” chapter of the *z/OS ISPF User's Guide Vol I*, except List ID, which is explained in “List data sets” on page 327, “Additional input libraries”, which is explained here and in “Input data sets” on page 326:

Term In the Term field, enter TERM if you want ISPF to generate a terminal data set. A *terminal data set* contains a synopsis of the error messages produced by the Assembler. If the input data set is partitioned, the terminal data set name is:
prefix.member.TERM

where *prefix* is the data set name prefix in your TSO user profile, if you have one, and *member* is the name of the member being assembled. However, if the input data set is sequential, the terminal data set name is: `prefix.TEMPNAME.TERM`

Enter NOTERM in the Term field to avoid generating the terminal data set. This is a required field.

Other Enter any other options you need in the Other field.

COBOL compile (option 5.2)

ISPF generates an ISPEXEC SELECT PGM(IGYCRCTL) statement to invoke a COBOL compiler using the values you enter on the Batch COBOL Compile panel, shown in Figure 205. For information about COBOL allocation data sets, see the topic about Allocation Data Sets in the *z/OS ISPF User's Guide Vol I*.

<u>M</u> enu	<u>R</u> efList	<u>U</u> tilities	<u>H</u> elp
Batch COBOL Compile			
			More: +
ISPF Library:			
Project . . .	PDFTDEV		
Group	LSACKV	. . .	_____ _____ _____
Type	COBOL		
Member . . .	_____	(Blank or pattern for member selection list)	
Other Partitioned or Sequential Data Set:			
Data Set Name . .	_____		
List ID	_____	(Blank for hardcopy)	
SYSOUT class	_____	(If hardcopy requested)	
Compiler options:			
Term . . .	NOTERM	(TERM or NOTERM)	
Other . . .	_____		
Additional input libraries:			
Command ==>	_____		
F1=Help	F2=Split	F3=Exit	F7=Backward F8=Forward F9=Swap
F10=Actions	F12=Cancel		

Figure 205. Batch COBOL Compile panel (ISRJP02)

All the fields on this panel are explained in the “ISPF Libraries and Data Sets” chapter of the *z/OS ISPF User's Guide Vol I*, except List ID, which is explained in “List data sets” on page 327, “Additional input libraries”, which is explained here and in “Input data sets” on page 326:

Term In the Term field, enter TERM if you want ISPF to generate a terminal data set. A *terminal data set* contains a synopsis of the error messages produced by the COBOL compiler. If the input data set is partitioned, the terminal data set name is:
`prefix.member.TERM`

where *prefix* is the data set name prefix in your TSO user profile, if you have one, and *member* is the name of the member being assembled. However, if the input data set is sequential, the terminal data set name is:
`prefix.TEMPNAME.TERM`

Batch— COBOL compile (option 5.2)

Enter NOTERM in the Term field to avoid generating the terminal data set. This is a required field.

Other If you plan to run VS COBOL II interactive debug after you compile your program, enter TEST, RESIDENT, and any other options you need in the Other field.

VS FORTRAN compile (option 5.3)

The Batch VS FORTRAN Compile panel is shown in Figure 206.

```
Menu  RefList  Utilities  Help
-----
Batch VS FORTRAN Compile
More:  +

ISPF Library:
Project . . . PDFTDEV
Group . . . LSACKV . . . _____ . . . _____ . . . _____
Type . . . FORT
Member . . . _____ (Blank or pattern for member selection list)

Other Partitioned or Sequential Data Set:
Data Set Name . . . _____

List ID . . . _____ (Blank for hardcopy)
SYSOUT class . . . _____ (If hardcopy requested)

Compiler options:
Term . . . NOTERM (TERM or NOTERM)
Other . . . _____

Additional input libraries:
Command ==> _____
F1=Help   F2=Split   F3=Exit   F7=Backward F8=Forward F9=Swap
F10=Actions F12=Cancel
```

Figure 206. Batch VS FORTRAN Compile panel (ISRJP03)

All the fields on this panel are explained in the “ISPF Libraries and Data Sets” chapter of the *z/OS ISPF User’s Guide Vol I* except List ID, which is explained in “List data sets” on page 327, “Additional input libraries”, which is explained here and in “Input data sets” on page 326:

Term In the Term field, enter TERM if you want ISPF to generate a terminal data set. A *terminal data set* contains a synopsis of the error messages produced by the VS FORTRAN compiler. If the input data set is partitioned, the terminal data set name is:

prefix.member.TERM

where *prefix* is the data set name prefix in your TSO user profile, if you have one, and *member* is the name of the member being assembled.

However, if the input data set is sequential, the terminal data set name is:

prefix.TEMPNAME.TERM

Enter NOTERM in the Term field to avoid generating the terminal data set. This is a required field.

Other If you plan to run FORTRAN interactive debug after you compile your program, enter TEST in the Other field, along with any other options you need.

PL/I compile (option 5.5)

The Batch PL/I Compile option enables you to invoke either OS PL/I Version 2 or PL/I for MVS and VM, using the values specified on the Batch PL/I compile panel shown in Figure 207.

<u>M</u> enu	<u>R</u> efList	<u>U</u> tilities	<u>H</u> elp
Batch PL/I Compile			
			More: +
ISPF Library:			
Project . . .	PDFTDEV		
Group	LSACKV	_____	_____
Type	PLI		
Member . . .	_____	(Blank or pattern for member selection list)	
Other Partitioned or Sequential Data Set:			
Data Set Name . .	_____		
List ID	_____ (Blank for hardcopy)	1	1. OS PL/I V2R3
SYSDOUT class . . .	_____ (For hardcopy)	2.	PL/I for MVS and VM
		3.	VA PL/I for OS/390
Compiler options:			
====>	_____		
Additional input libraries:			
Command ==>	_____		
F1=Help	F2=Split	F3=Exit	F7=Backward F8=Forward F9=Swap
F10=Actions	F12=Cancel		

Figure 207. Batch PL/I Compile panel (ISRJP05)

All the fields on this panel are explained in the “ISPF Libraries and Data Sets” chapter of the *z/OS ISPF User’s Guide Vol I* except List ID, which is explained in “List data sets” on page 327, “Additional input libraries”, which is explained in “Input data sets” on page 326.

Compiler

Choose the compiler you want to use from the list presented.

VS Pascal compile (option 5.6)

The Batch VS Pascal Compile panel is shown in Figure 208 on page 362.

Batch—VS Pascal compile (option 5.6)

```
Menu  RefList  Utilities  Help
-----
                                Batch VS PASCAL Compile
                                More:    +
ISPF Library:
Project . . . PDFTDEV
Group . . . LSACKV . . . _____ . . . _____ . . . _____
Type . . . PASCAL
Member . . . _____ (Blank or pattern for member selection list)

Other Partitioned or Sequential Data Set:
Data Set Name . . _____

List ID . . . . . _____ (Blank for hardcopy)
SYSOUT class . . . . _____ (If hardcopy requested)

Compiler options:
====> _____

Additional input libraries:
====> _____

Command ====> _____
F1=Help   F2=Split   F3=Exit   F7=Backward F8=Forward F9=Swap
F10=Actions F12=Cancel
```

Figure 208. Batch VS Pascal Compile panel (ISRJP06)

All the fields on this panel are explained in the “ISPF Libraries and Data Sets” chapter of the *z/OS ISPF User’s Guide Vol I* except List ID, which is explained in “List data sets” on page 327, and “Additional input libraries”, which is explained in “Input data sets” on page 326.

Binder/linkage editor (option 5.7)

The Batch Binder or Linkage Editor is called from the Batch Binder/Linkage editor panel. The panel in Figure 209 on page 363 shows entries you might make when link-editing a VS Pascal program.

```

Menu  RefList  Utilities  Help
-----
                                Batch Binder/Linkage Editor
                                More:      +

ISPF Library:
Project . . . PDFTDEV
Group . . . COMMON . . . _____ . . . _____ . . . _____
Type . . . LEL
Member . . . _____ (Blank or pattern for member selection list)

Other Partitioned or Sequential Data Set:
Data Set Name . . _____

List ID . . . . . _____ (Blank for hardcopy)
SYSOUT class . . _____ (For hardcopy)
Processor
- 1. Binder
- 2. Linkage Editor

Linkage editor/binder options:
Term . . . _____ (TERM or blank)
Other . . . _____

Command ==>
F1=Help   F2=Split   F3=Exit   F7=Backward  F8=Forward  F9=Swap
F10=Actions  F12=Cancel
    
```

Figure 209. Batch Binder Linkage/Editor panel (ISRJP07B)

All the fields on this panel are explained in the “ISPF Libraries and Data Sets” chapter of the *z/OS ISPF User’s Guide Vol I* except List ID, which is explained in “List data sets” on page 327, and here:

Binder

Determines whether the Linkage Editor (NOBINDER) or Binder (BINDER) is invoked.

Note: The binder is available only if DFSMS 1.1, or later, is installed.

Term

In the Term field, enter TERM if you want ISPF to generate a terminal data set. A *terminal data set* contains a synopsis of the error messages produced by the linkage editor. If the input data set is partitioned, the terminal data set name is:

prefix.member.TERM

where *prefix* is the data set name prefix in your TSO user profile, if you have one, and *member* is the name of the member being assembled.

Note: Sequential data sets are invalid when using the Linkage Editor.

Leave the Term field blank to avoid generating the terminal data set.

Other

Enter any other options you need in the Other field.

SYSLIB

The name of the data set that is to contain the ISPF library concatenation sequence used to resolve any copy statements specified in your program. See “Input data sets” on page 326 and the SYSLIB Data Set section of the topic about Allocation Data Sets in the *z/OS ISPF User’s Guide Vol I* for more information.

SYSLIN

The name of the data set that is to contain the object module. The SYSLIN field is provided to accommodate the VS Pascal XA and NOXA processing

Batch—binder/linkage editor (option 5.7)

options. See “Input data sets” on page 326 and the SYSLIN Data Set section of the topic about Allocation Data Sets in the *z/OS ISPF User’s Guide Vol I* for more information.

VS COBOL II interactive debug (option 5.10)

Before you can run VS COBOL II interactive debug in batch, you must first perform these tasks in the order shown:

1. Compile the program using the VS COBOL II compiler (option 4.2 or option 5.2) with the TEST and RESIDENT options.
2. Use the linkage editor (option 4.7 or option 5.7) to generate an output load module, which VS COBOL II interactive debug will use as input.

The VS COBOL II Interactive Debug panel is shown in Figure 210.

```
Menu  RefList  Utilities  Help
-----
VS COBOL II Interactive Debug
More:  +

ISPF Library:
Project . . . LSACKV
Group . . . PRIVATE (Type = LOAD assumed)
Member . . . (Blank or pattern for member selection list)

Other Partitioned or Sequential Data Set:
Data Set Name . . .

List ID . . . . . (Blank for hardcopy)
SYSOUT class . . . A (If hardcopy requested)

Debug command data set:
===>

Additional input libraries:
===>
===>

Command ===>
F1=Help   F2=Split   F3=Exit   F7=Backward  F8=Forward  F9=Swap
F10=Actions  F12=Cancel
```

Figure 210. VS COBOL II Interactive Debug panel (ISRJP10)

All the fields on this panel are explained in the “ISPF Libraries and Data Sets” chapter of the *z/OS ISPF User’s Guide Vol I* except List ID, which is explained in “List data sets” on page 327, “Additional input libraries”, which is explained in “Input data sets” on page 326, and here:

Note: For VS COBOL II interactive debug, any additional input libraries that you enter to complete the search sequence must be LOAD libraries only.

Debug command data set

In the “Debug command data set” field, enter the name of the data set that contains the DEBUG command that you want VS COBOL II interactive debug to enter during batch processing. See *VS COBOL II Application Programming Debugging Guide* for more information.

Member parts list (option 5.12)

When you select the Batch Member Parts List option (5.12), the panel shown in Figure 211 is displayed.

The only difference between this panel and the Foreground Member Parts List panel is that option 1 (print member parts) is called *Browse/Print member parts list* in foreground. The foreground version does not print your member parts list unless you use the Foreground Print Options panel to do so.

Otherwise, this version operates the same as the foreground version. See “Member parts list (option 4.12)” on page 347 for more information about using the member parts list function.

The listing is 120 characters wide and uses ANSI printer controls.

```

Menu  RefList  Utilities  Help
-----
                                Batch Member Parts List

1 Print member parts
2 Write member parts data set

ISPF Library:
Project . . . LSACKV
Group . . . PRIVATE . . . _____ . . . _____ . . . _____
Type . . . _____
Member . . . _____ (Blank or pattern for member selection list)

Language . . . COB (Defaults to Type value)

Groups for Primary members . . . 1 (1, 2, 3, or 4)

SYSOUT class . . . _____ (Defaults to A )

Output Data Set: (option 2 only)
Data Set Name . . . _____
Option ==>
F1=Help   F2=Split   F3=Exit   F7=Backward F8=Forward F9=Swap
F10=Actions F12=Cancel

```

Figure 211. Batch Member Parts List panel (ISRJP12)

C/370 compile (option 5.13)

ISPF supports the C/370 compiler through dialogs supplied with the C/370 compiler (5688-040). See *C Compiler User's Guide for MVS*, SC09-1129 for additional information.

REXX/370 compile (option 5.14)

ISPF supports the REXX/370 compiler through dialogs supplied with the REXX/370 compiler (5695-013). See *IBM Compiler and Library for REXX/370 User's Guide and Reference*, SH19-8160, for additional information.

Batch Ada/370 compile (option 5.15)

Ada/370 compile (option 5.15)

ISPF supports the Ada/370 compiler and its tools through dialogs supplied with the Ada/370 compiler (5706-292). See *IBM Ada/370 User's Guide*, SC09-1415, for additional information.

AD/Cycle C/370 compile (option 5.16)

ISPF supports the AD/Cycle C/370 compiler through dialogs supplied with the AD/Cycle C/370 compiler (5688-216). See *IBM SAA AD/Cycle C/370 Programming Guide* SC09-1356, for additional information.

ISPDTLC compile (option 5.18)

ISPF supports the ISPF Dialog Tag Language compiler by running the ISPDTLC function. See *z/OS ISPF Dialog Tag Language Guide and Reference* for more information.

The ISPDTLC interface panels are identical to those in the Foreground option. The first panel can be seen in Figure 201 on page 352.

The fields on this panel are explained in the topic "Using the Conversion Utility" in *z/OS ISPF Dialog Tag Language Guide and Reference*.

OS/390 C/C++ compile (option 5.19)

ISPF supports the OS/390 C/C++ compiler and its tools through dialogs supplied with the OS/390 C/C++ compiler (5647-A01). For information about OS/390 C/C++, refer to the *OS/390 C/C++ User's Guide*.

Chapter 8. Command (option 6)

When you select this option, the ISPF Command Shell panel shown in Figure 212 is displayed. You can enter TSO commands, CLISTs, and REXX EXECs on the Command line of any panel and in the Line Command field on data set list displays (option 3.4). However, the ISPF Command Shell panel provides additional capabilities:

- You can enter TSO commands, ISPF commands, CLISTs, and REXX execs in a separate, but optional, **ISPF Command** field. This field is displayed only if your installation chooses to do so. The default panel shown in Figure 212 does not display this field. When you use this field, commands that are typed in the TSO Command Entry field (==>) are not blanked out when you enter the SPLIT command to split the screen.

Note: If you use this field, you will not have access to the saved command area (see “The saved command area” on page 369).

- You can enter Session Manager mode, but only if this licensed program is installed. See “Using the session manager” on page 370 for more information.
- You can enter a long command that continues on these two lines.

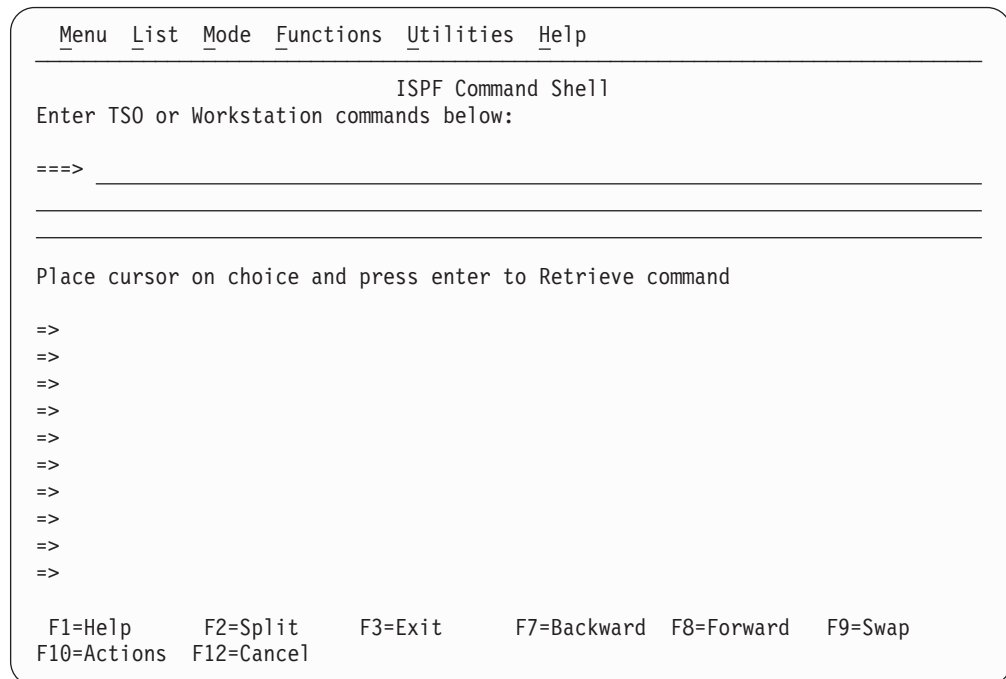

Figure 212. ISPF Command Shell panel (ISRTSO)

ISPF command shell panel action bar

The ISPF Command Shell panel action bar choices function as follows:

Note: The ISPF Command Shell panel action bar contains three pull-down choices that let you control the saved command area.

- List
- Mode

Command (option 6)

- Functions

Menu For more information, see the details about the Menu Action Bar Choice in the ISPF User Interface topic in the *z/OS ISPF User's Guide Vol I*.

List The List pull-down offers you these choices:

Update On

Makes the list of commands in the saved command area *live*; that is, new commands are appended automatically.

Update Off

Makes the list of commands in the saved command area *static*; that is, new commands are not appended automatically.

The current setting is shown as an unavailable choice.

Mode The Mode pull-down offers you these choices:

Retrieve

Allows commands to be retrieved from the saved command area and placed on the TSO Command Entry field (==>) so that you can edit them before they are executed. This mode is the default.

Execute

Allows commands to be retrieved from the saved command area and executed in one step.

Delete Allows you to delete commands from the saved command area without executing the commands. Place the cursor on the command to be deleted and press Enter. The command will be blanked out. This process allows you to delete a command if you are running with Update mode set off.

The current setting is shown as an unavailable choice.

Functions

The Functions pull-down offers you this choice:

Compress List

Removes duplicate entries and blank spaces in the saved command area if you are running with Update mode set off. Entries are compressed automatically in Update mode.

TSO command

Sets the command shell to route commands to TSO

Workstation command

Sets the command shell to route commands to your workstation.

Note:

1. Workstation command is available only if you are running the ISPF Client Server.
2. Any command may be prefixed with either TSO or WS to override the command function setting.

Utilities

For more information, see the details about the Utilities Action Bar Choice in the ISPF User Interface topic in the *z/OS ISPF User's Guide Vol I*.

Help The Help pull-down provides general information on the TSO Command processor panel, including line I/O mode and Session Manager mode, and restrictions on entering commands.

The saved command area

The ISPF Command Shell panel has a saved command area (the bottom portion of the screen) that contains a list of up to 10 commands that you have saved; see Figure 213 for an example. These commands are point-and-shoot fields. What happens when you select a command depends on the mode you specify from the Mode pull-down menu on the action bar.

```

  Menu  List  Mode  Functions  Utilities  Help
  -----
                                ISPF Command Shell
  Enter TSO or Workstation commands below:

  ==>> _____
  _____
  _____

  Place cursor on choice and press enter to Retrieve command

  => status
  => xmit carvm3.userid da('userid.private.clist(types)')seq
  => TIME
  => RECEIVE
  => XMIT CARVM3.SCOTT DA('USERID.PROJ.PANELS(ISAJP10)') SEQ
  => PERMIT 'BOB.*' GENERIC ACCESS(READ) ID(*)
  => rexec -1 SQUIRT -p SPARKY p:\acI13\samples\isr prim\os213\isr_prim
  => XMIT CARVM3.userid DA('USERID.BUILD.LIST77')
  => ssdf
  => XMIT CARVM3.userid DA('USERID.trace')

  F1=Help      F2=Split      F3=Exit      F7=Backward  F8=Forward  F9=Swap
  F10=Actions  F12=Cancel

```

Figure 213. ISPF Command Shell panel with saved commands (ISRTSO)

Entering TSO commands, CLISTs, and REXX EXECs

You do not need to enter TSO before the command on this panel as you do on other panels, unless the command exists in both ISPF and TSO and you want to process the TSO command. If you use TSO, your processed command is blanked out when the ISPF Command Shell panel is displayed again.

TSO commands, CLISTs, and REXX EXECs entered are invoked using the ISPF SELECT CMD service. Variable names starting with an ampersand (&) are evaluated by ISPF. If you want the underlying command processor to see the ampersand you must specify 2 ampersands. For example:

```
DEF NONVSAM(NAME('MY.DATASET') DEVT(0000) VOLUME(&&SYSR2))
```

For example, the HELP, PRINT, and CANCEL commands are interpreted as the ISPF HELP, PRINT, and CANCEL commands, unless you precede them with TSO. Therefore, to get TSO HELP information, enter:

```
==>> TSO HELP xxx
```

Rules for entering TSO commands

Do not enter these commands under ISPF:

- LOGON and LOGOFF
- ISPF, PDF, or ISPSTART

Command (option 6)

- TEST
- Commands that are restricted by TSO or ISPF
- Commands that call a program authorized by the Authorized Program Facility (APF), except for the TSO CALL command
- ISPEXEC service calls.

Rules for entering CLISTs and REXX EXECs

You can enter a CLIST name or REXX exec name on this panel, but these restrictions apply:

- The CLIST or REXX exec cannot call the restricted commands shown in the preceding list. However, this does not apply to ISPEXEC, which can be called in a CLIST or REXX exec.
- CLIST error exits are not entered for ABENDs.
- CLIST TERMIN command procedure statements may cause unwanted results.

Note: Remember that a command issued through an alias may contain some of the characteristics listed here and thus may cause unwanted results.

Using the session manager

If the Session Manager licensed program is installed and available, you can use it by selecting Session Manager mode on the ISPF Settings panel. For information on altering the PDF configuration table to allow you to enter Session Manager mode, refer to *z/OS ISPF Planning and Customizing*.

If you select this option, any display output is displayed in the Session Manager TSOOUT stream.

Note: If GDDM/ISPF mode is active, Session Manager does not get control of the screen. GDDM/ISPF mode is started when a GRINIT service has been issued, but a GRTERM service has not been issued. See *z/OS ISPF Services Guide* for more information about these two services.

The function key definitions are not transferred to the Session Manager from ISPF. When the command ends, the Session Manager prompts you to enter a null line to return to ISPF control and displays the TSO Command Processor panel again when you do so.

If you do not select Session Manager mode, terminal I/O occurs as though the Session Manager were not installed. The terminal operates in normal TSO fashion. Any communication with the command is in line-I/O mode. When the command ends, three asterisks (***) are displayed. Press Enter to display the TSO Command Processor panel again in full screen mode.

To interrupt a TSO command, CLIST, or REXX exec, press the PA1 key. The TSO command ends and the TSO Command Processor panel is displayed again. If terminal input is inhibited, press the Reset key before pressing the PA1 key. If you are in Session Manager mode, enter a null line to return to ISPF full-screen mode.

When the TSO Command Processor panel is displayed again, the command that was just processed is displayed to the right of the arrow. Enter another command or the END command to return to the ISPF Primary Option Menu.

For terminals with primary and alternate screen sizes, ISPF does not check to make sure the same screen settings are in effect when a command, CLIST, or REXX exec ends. If you call a CLIST, REXX exec, or command that changes the screen settings, you are responsible for saving and restoring them before control is returned to ISPF.

Chapter 9. Dialog test (option 7)

This topic describes Dialog Test, option 7 on the ISPF Primary Option Menu.

Dialog Test (option 7) provides you with facilities for testing both complete ISPF applications and ISPF dialog parts, including functions, panels, variables, messages, tables, and skeletons. The Dialog Test option allows you to:

- Call selection panels, command procedures, and programs
- Display panels
- Add new variables and change variable values
- Display a table's structure and status
- Display, add, modify, and delete table rows
- Browse the ISPF log
- Process dialog services
- Add, modify, and delete function and variable trace definitions
- Add, modify, and delete breakpoint definitions.

You can use TSO TEST to complement this option if you want to examine and manipulate non-ISPF storage areas.

You usually test a dialog in one of two ways:

- Test individual dialog parts, including panels, skeletons, and messages, without calling a function or a selection panel. Eventually, you end your test session by entering the END command on the Dialog Test Primary Option Panel.
- Test dialog functions, including programs, commands, and selection panels, using the Functions option (7.1). You can define traces and breakpoints before calling the function.

Any requested traces for variable usage and dialog service calls are written to the ISPF log. You can browse the log using the Log option (7.5).

If you define a breakpoint and the function gets to it, dialog processing is suspended, and Dialog Test displays the Breakpoint Primary Option Panel (Figure 236 on page 418). At this point, you can access and manipulate dialog parts, such as variables, tables, and so forth. Then, if you select the Go option from the Breakpoint Primary Option Panel, the dialog resumes processing.

When the processing is complete, you are returned to the Functions option (7.1). If you select the Cancel option from the Breakpoint Primary Option Panel, the dialog is canceled and the first primary option panel that you were shown during your terminal session is displayed again. For example, if the first screen displayed when you began your session was a master application panel that is different from the ISPF Primary Option Menu, that master application panel is displayed again.

The dialog test environment

The Dialog Test Primary Option Panel, shown in Figure 214 on page 374, follows the conventions for a primary option panel. If you use the RETURN command from one of the selected Dialog Test options, the Dialog Test Primary Option Panel is displayed again. If you use the END command from this panel, you return to the ISPF Primary Option Menu.

Dialog test (option 7)

When you enter Dialog Test from the ISPF Primary Option Menu, you enter a new user application with an ID of ISR. When you enter Dialog Test from the ISPF primary option panel, you enter a new user application with an ID of ISP. All options listed on the Dialog Test Primary Option Panel operate in this context. If you call a new function using the Functions options (7.1), a SELECT service call is performed, and the rules for the SELECT service are followed.

```
Menu Utilities Compilers Options Status Help
      Dialog Test
  Menu Utilities View Help
  Primary Option Panel
1 Functions      Invoke dialog functions/selection panel
2 Panels         Display panels
3 Variables      Display/set variable information
4 Tables         Display/modify table information
5 Log           Browse ISPF log
6 Dialog Services Invoke dialog services
7 Traces         Specify trace definitions
8 Breakpoints    Specify breakpoint definitions
T Tutorial       Display information about Dialog Test
X Exit          Terminate dialog testing
Option ==>>
F1=Help      F2=Split      F3=Exit      F4=Expand      F5=Rfind
F6=Resize    F7=Backward    F8=Forward    F9=Swap      F10=Actions

Option ==>> 7
F1=Help      F2=Split      F3=Exit      F7=Backward    F8=Forward    F9=Swap
F10=Actions  F12=Cancel
```

Figure 214. Dialog test primary option panel (ISPYXD1)

Note: You can set the application ID under which you enter the Dialog Test function using the Dialog Test appl ID choice from the Options pull-down on the ISPF Primary Option Menu or using the Dialog Test appl ID choice from the Test pull-down on an Edit panel.

After you begin an application under Dialog Test, you can enter the DTEST command with one of its parameters as a quicker way to start a dialog test function. For example, if you enter **DTEST 8** on the command line, the Option 7.8 Breakpoints panel is displayed. The other parameters of the DTEST command also match the dialog test function they perform:

- 1 invoke Functions panel
- 2 invoke Display Panel panel
- 3 invoke Variables panel
- 4 invoke Tables panel
- 5 display Browse Log panel
- 6 invoke Dialog Services panel
- 7 invoke Traces selection panel
- 8 invoke Breakpoint panel

You must use a parameter with the DTEST command, otherwise an error message appears. After you complete the entries on whichever dialog test panel you invoke, leaving the panel returns you to the application you were running with the new entries in place.

Dialog Test is itself a dialog and, therefore, uses dialog variables. Because it is important to allow your dialog to operate without interference, as though in a production environment, Dialog Test accesses and updates variables independently of your dialog variables.

All breakpoints and traces that you set in Dialog Test exist only while you remain within the Dialog Test option.

You should always allocate the ISPF log when using Dialog Test. Do not suppress its generation by typing 0 in the "Primary pages" field that appears on the "Log Data set defaults" and "List Data set defaults" choices from the Log/List pull-down on the ISPF Settings panel. Dialog Test writes trace data to the log when you request it. Also, if Dialog Test finds an unexpected condition, it writes problem data to the log.

When you enter Dialog Test, you are given these ISPF facilities:

- All functions you normally get by specifying the TEST parameter on the ISPSTART command
- Logging of all severe errors, both from user dialogs and Dialog Test. This is normally done when you specify TRACE or TRACEX on the ISPSTART command.
- Suspension of the logging of all ISPEXEC dialog service requests. Such logging normally occurs when you specify TRACE or TRACEX on the ISPSTART command. You should use the Traces option (7.7).

These facilities become active for all logical screens when you are using split-screen mode. At the completion of the last dialog test session (dialog test is no longer active in any logical screen), these options will be restored to the original values established during dialog manager start-up. Optionally, by making the appropriate selection on the ISPF Settings panel, the facilities established by dialog test will remain in effect after the last dialog test session terminates.

Dialog test primary option panel action bar

The Dialog Test Primary Option Panel action bar choices function as follows:

Menu For more information, see the details about the Menu Action Bar Choice in the ISPF User Interface topic in the *z/OS ISPF User's Guide Vol I*.

Utilities

For more information, see the details about the Utilities Action Bar Choice in the ISPF User Interface topic in the *z/OS ISPF User's Guide Vol I*.

View Allows you to select whether the Add row, Modify row, and Display row panels are displayed in pop-up windows and whether Dialog Services (option 7.6) are displayed in a pop-up. By displaying the panel in a pop-up window, you can see the panel underneath and move the window. By displaying the panel as a full-screen display, you can see more data. The setting you choose will remain until you change it.

Help The Help pull-down provides general information about Dialog Test topics as well as information about each available choice on the Dialog Test Primary Option panel.

Using variables

When you select the Dialog Test option from the ISPF Primary Option Menu, you are given a new function pool, a new shared pool, and the profile pool for the application ID under which you entered Dialog Test. When you select Dialog Test from the ISPF Primary Option Menu, you are given a new function pool, a new shared pool, and the ISPPROF profile pool. These pools are used if you set a variable, display a panel, call an ISPF service, and so forth. When you call a new dialog, Dialog Test uses the SELECT service, and follows the rules for the creation of new variable pools. For example, if you call a new dialog using the NEWPOOL option, Dialog Test creates new shared and function variable pools for you. The profile variable pool, ISRPROF or ISPPROF, remains as it was.

If you set a dialog variable in the shared pool from a dialog running under Dialog Test and then call the dialog again from the Command line, you cannot retrieve the value of that variable.

Dialog variables should be initialized and set in the context of the dialog's processing. A dialog's function variable pools are created when it is called; that is, when the SELECT is done. Therefore, to set function variables in newly created pools, you must define a breakpoint early in your dialog's processing, at a point before the function is called.

For example, if you call a dialog with the NEWPOOL parameter, you must define a breakpoint in the dialog before the first function is called to access that dialog's function and shared variable pools. You can change the dialog's profile variable pool before calling the dialog, since a new profile variable pool is not created.

When your dialog ends, all variable pools that were created when the dialog was called are deleted.

Note: ISPF does not support TSO global variables. You can find a severe dialog test error when testing a dialog that refers to a global variable.

Severe error handling

If your dialog finds a severe error when it calls a dialog service, the error is handled as requested by the dialog. The current CONTROL service ERRORS setting, CANCEL or RETURN, determines what is done. If CANCEL is in effect, you can choose whether to continue dialog testing when the Error Message panel is displayed.

Note: If you choose not to continue dialog testing, you return to the ISPF Primary Option Menu. The TEST and TRACE options set by dialog test are restored to the values originally established during dialog manager start-up. Optionally, by making the appropriate selection on the ISPF Settings panel, the facilities established by dialog test will remain in effect after the last dialog test session terminates.

If you find a severe error when manipulating your dialog at a breakpoint, Dialog Test assumes that the CONTROL service ERRORS setting is CANCEL. For example, if you display a panel at a breakpoint and that panel is not found, the Error Message panel is displayed. This occurs even if your current dialog has an ERRORS setting of RETURN.

Regardless of the ERRORS setting, all your severe errors are logged.

If Dialog Test finds a severe error during its processing, the details are logged and this message is shown to you on an error message display:

```
Test severe error
Details precede this message in the ISPF log
```

Dialog Test errors can occur because:

- Proper ISPF libraries are not being used.
- A programming problem has been found.
- You have attempted to process Dialog Test.
- You have called a Dialog Test option without being in test mode or without calling Dialog Test first.

Browse the ISPF log to find the problem; see “Log (option 7.5)” on page 404 for more information.

Commands

You can enter ISPF primary commands on Dialog Test panels. Seven commands have special meaning during Dialog Test operations. You enter them in the Command line of the applicable Dialog Test option panel. These commands, and the Dialog Test options with which they function, are:

Primary Command

Valid Options

CANCEL

- Variables (option 7.3)
- Tables (option 7.4)¹
- Traces (option 7.7)²
- Breakpoints (option 7.8)

END

- Variables (option 7.3)
- Tables (option 7.4)³
- Traces (option 7.7)²
- Breakpoints (option 7.8)

LOCATE

- Variables (option 7.3)
- Tables (option 7.4)⁴
- Traces (option 7.7)²
- Breakpoints (option 7.8)

NEXT/PREV

- Tables (option 7.4)⁴

QUAL

- Breakpoints (option 7.8)

1. Valid only with Tables options 3 and 4.

2. Valid only with Traces options 1 and 2.

3. Valid only with Tables options 1, 3, and 4.

4. Valid only with Tables options 1 and 3.

Dialog test (option 7)

RESUME

- Breakpoints (option 7.8)

SORT

- Variable (option 7.3)

Dialog Test has three line commands that have special meaning during testing operations. These commands, and the options with which they function, are:

Line Command

Valid Options

D (delete)

- Variables (option 7.3)
- Tables (option 7.4) ¹
- Traces (option 7.7) ²
- Breakpoints (option 7.8)

I (insert)

- Variables (option 7.3)
- Tables (option 7.4) ¹
- Traces (option 7.7) ²
- Breakpoints (option 7.8)

R (repeat)

- Tables (option 7.4) ¹
- Traces (option 7.7) ²
- Breakpoints (option 7.8)

When using the Dialog Test primary and line commands, you should be aware that:

- You can specify both a primary command and line commands before you press the Enter key.
- You can enter multiple line commands on the display.
- You cannot carry out a deletion if one of the included lines contains another line command.
- You can delete lines that contain an input error.
- The line commands are processed in row order when you press the Enter key. Any fields changed in the row are handled before a line command is processed.
- A primary command is handled after processing for all line commands is complete.
- As in the ISPF editor, you can specify a number with each line command to denote repetitive operation, unless you are using the Variables option (7.3). To avoid conflict with the I (insert) line command, the Variables option does not allow you to type a number along with the D command to delete more than one line simultaneously. Therefore, enter a single D line command on each line you want to delete. Unlike the ISPF editor, the Variables option does not support block deletes; however, you can enter this command on more than one line before pressing the Enter key.

Ending the current option without saving changes

The CANCEL command ends the current option. Any changes made to the data are ignored.

Saving changes

The END command ends the current option. Any changes made to the data now take effect.

Finding a character string

The LOCATE command searches for a character string and positions a scrollable display to the next row that contains the string. The scan starts at the end of the first row currently being displayed. A message is displayed indicating the result of the scan.

LOCATE *string*

where:

string

The character string you are trying to find. If the string ends in an asterisk (*), a scan for the characters preceding the asterisk is done. The asterisk is optional in the Variables option (option 7.3).

Displaying breakpoint qualification data

The QUAL command can only be entered from the Breakpoints pop-up window. It displays the breakpoint qualification data.

The same breakpoint qualification data can be obtained using the Qualifications choice on the Qualify pull-down.

Restoring the format of the Breakpoints panel

The RESUME command is entered on the Breakpoints panel when qualification parameter values are shown. It restores the format of the Breakpoints panel. Each breakpoint that has qualification is flagged by the characters *QUAL* in columns 75 to 80 on that line of the Breakpoints panel.

Dialog test line commands

These line commands have special meaning during testing operations:

D – deleting lines

The D command deletes one line or *n* lines starting with this line. The syntax is:

►► D 1 n ◀◀

If you are using the Variables option (7.3), the *n* operand does not apply. To avoid conflict with the I (insert) line command, the Variables option does not allow you to type a number along with the D command to delete more than one line simultaneously. Therefore, enter a single D line command on each line you want to delete. You can enter this command on more than one line before pressing the Enter key.

I – inserting lines

The I command inserts one line or *n* lines directly after this line, with underscores and quotation marks in the appropriate fields. The syntax is:

Dialog test (option 7)



R – repeating lines

The R command repeats this line once or *n* times. The syntax is:



Setting a keylist for dialog test

Depending on your needs and preferences, you may wish to set a dialog test-specific keylist to enhance productivity. To modify the default function key settings, go to the Dialog Test Primary Option Panel, type KEYS on the Command line, and press Enter to display the pop-up window shown in Figure 215. Or, you may perform these steps to display the pop-up:

1. Select Option 0 from the ISPF Primary Option Menu.
2. Select Keylist settings from the Function keys pull-down on the ISPF Settings panel action bar.
3. Use a slash to select the ISPTTEST Keylist; then select Change from the Functions pull-down.

Key	Definition	Format	Label
F1 . . .	HELP	SHORT	Help
F2 . . .	SPLIT	LONG	Split
F3 . . .	EXIT	SHORT	Exit
F4 . . .	EXPAND	SHORT	Expand
F5 . . .	RFIND	SHORT	Rfind
F6 . . .	RESIZE	SHORT	Resize
F7 . . .	UP	LONG	Backward
F8 . . .	DOWN	LONG	Forward
F9 . . .	SWAP	LONG	Swap

Figure 215. Keylist change panel (ISPPLUCH)

On the Keylist Change panel, you can reassign existing function keys by typing over the information in the data fields, or create a new function key assignment to suit your needs. For example, you could assign the GO command to F4 if you typically issue GO many times during a dialog test.

If you press F3 or select Save and Exit from the File pull-down, the values that you have assigned will be valid when you return to Dialog Test. If you select Cancel from the File pull-down, the fields return to their original values.

Functions (option 7.1)

The Functions option (7.1) allows you to test a dialog function without having to build supporting code or panels. Dialog functions include panels, command procedures, and programs. The name of the dialog function and the parameters you can pass are the same as those that you can specify from a dialog function when you call the SELECT service. When you press the Enter key, a SELECT service is called.

If you call a new function or selection panel at a breakpoint, the previous function or selection panel is suspended and the new one is processed. When the new activity finishes, the Invoke Dialog Function/Selection Panel is displayed. The old activity resumes when you enter the END command. When the function that was called originally finishes processing, the Invoke Dialog Function/Selection Panel is displayed again.

When you select the Functions option, the scrollable panel shown in Figure 216 is displayed to allow you to specify the dialog function that you want to test. Press F8=Forward to display the rest of the panel.

```

Menu Utilities Compilers Options Status Help
Dialog Test
Menu Save Utilities Help
Invoke Dialog Function/Selection Panel
More: +
Invoke selection panel:
PANEL . . _____
OPT . . . _____
Invoke command:
CMD . . . _____
LANG . . . _____ (APL, CREX, or blank)
MODE . . . _____ (LINE, FSCR, or blank)
Invoke program:
PGM . . . _____
PARM . . . _____
Command ==>
F1=Help      F2=Split    F3=Exit     F4=Expand   F5=Rfind
F6=Resize    F7=Backward F8=Forward  F9=Swap     F10=Actions
    
```

Figure 216. Invoke Dialog Function/Selection panel (ISPYFP)

There are two alternate Invoke Dialog Function/Selection panels, ISPYFPA and ISPYFPB. ISPYFPA is formatted with the most often used fields at the top of the scrollable area. ISPYFPB is similar, but it has a selection field for panel, command, program, or request selection. Unlike panel ISPYFP and ISPYFPA, when you use ISPYFPB the panel, command, program, and request selection fields can all contain values.

You can specify one of the alternate panels using the ISPF Configuration utility. See *z/OS ISPF Planning and Customizing* for more information.

Functions (option 7.1)

One of the advantages of placing dialog panels in pop-up windows is that you can move the pop-up within the 3270 physical display area to reveal portions of the underlying panel.

See *z/OS ISPF Dialog Developer's Guide and Reference* for instructions on how to move a pop-up window.

Invoke dialog function/selection panel action bar

The Invoke Dialog Function/Selection Panel action bar choices function as follows:

Menu For more information, see the details about the Menu Action Bar Choice in the ISPF User Interface topic in the *z/OS ISPF User's Guide Vol I*.

Save Allows you to specify that you want to save or clear input field information when you exit this panel.

Utilities

For more information, see the details about the Utilities Action Bar Choice in the ISPF User Interface topic in the *z/OS ISPF User's Guide Vol I*.

Help The Help pull-down offers you these choices:

- 1 General
- 2 Invoke Function Panel
- 3 Usage Notes
- 4 General Dialog Test

Invoke dialog panel fields

To call a function, you must specify a value for either the PANEL, CMD, or PGM field. You cannot specify more than one of these fields.

The fields on the Invoke Dialog Function/Selection Panel function as follows:

Invoke selection panel:

Use these fields to call a selection panel:

PANEL

The name of the selection panel to be displayed.

OPT An optional parameter indicating the first selection option that must be valid from the specified selection panel. This input field continues onto the next line on the panel.

Invoke command:

Use these fields to call a command:

CMD The name of a command procedure written in CLIST or REXX, or any TSO command, to be called as a dialog function. You can include command parameters.

Use the percent sign (%) as a prefix symbol to tell ISPF to remove the Invoke Dialog Function/Selection Panel and use the full screen to display the results of a CLIST or REXX exec call. A complete CLIST or REXX exec call is indicated by three asterisks. Press the Enter key to return to the Invoke Dialog Function/Selection Panel.

If you omit the % prefix, ISPF interprets the command as a TSO command, using line mode to display the command results at the bottom of the Invoke Dialog Function/Selection Panel.

LANG

An optional parameter used to specify APL or CREX.

Type APL in this field to specify the use of the APL language. If this is your first APL request during the session, the command specified in the CMD keyword is called and an APL2[®] environment is established. If this is not your first APL request during this session, the string specified after the CMD keyword is passed to the APL2 workspace and processed.

Type CREX in this field to specify that the command specified in the CMD keyword is a REXX exec that has been compiled and link-edited into a load module, and that a CLIST/REXX function pool is to be used rather than an ISPF module function pool. LANG(CREX) is optional if the compiled REXX has been link-edited to include any of the stubs EAGSTCE, EAGSTCPP, or EAGSTMP.

See *z/OS ISPF Dialog Developer's Guide and Reference* for more information about Compiled REXX processing.

To specify any language other than APL or Compiled REXX, leave this field blank.

MODE

An optional parameter that overrides:

- Automatic line mode entry, caused when a TSO command is entered.
- Automatic full-screen display caused by the % CLIST or REXX exec prefix. However, it does not prevent ISPF from calling the command as a CLIST or REXX exec.

If you leave this field blank, the % prefix has its normal effect. The valid values for this field are:

LINE Used to enter line mode when calling a CLIST or REXX exec.

FSCR Used to enter full-screen mode when calling a TSO command.

Invoke program:

Use these fields to call a program:

PGM The name of a program to be called as a dialog function.

PARM Optional parameters to be passed to the program. This input field continues onto the next line on the panel.

MODE

An optional parameter used to tell ISPF whether to display the program results in line mode or full-screen mode. If you leave this field blank, ISPF uses line mode as the default. The valid values for this field are:

LINE Used to enter line mode when calling a program. Results of the program are displayed at the bottom of the Invoke Dialog Function/Selection Panel.

FSCR Used to enter full-screen mode when calling a program. ISPF removes the Invoke Dialog Function/Selection Panel and uses the full screen to display the program results. Three asterisks show program completion. Press the Enter key to return to the Invoke Dialog Function/Selection Panel.

Functions (option 7.1)

Invoke request:

Use this field to call a workstation command:

WSCMD

A fully qualified workstation command with any of its parameters.

Options:

Use a slash to select these options:

NEWAPPL

Indication of whether a new application is being called. Select this option if the function is a new application.

ID

A 1- to 4-character ID for a new application. If you call a new application and leave the ID field blank, the default ID of ISP is used. Note that the ID determines the names of the profile and the command table to be used for the application.

NEWPOOL

Indication of whether a new shared variable pool is to be created. Select this option if you want to create a new shared variable pool; however, the selection is ignored if NEWAPPL is selected.

PASSLIB

Shows that the current set of application-level ISPF libraries, if any sets exist, is to be used by the application being selected. You can select PASSLIB only if you also select NEWAPPL.

Note: For more information about the PASSLIB field, see the description of the SELECT service in *z/OS ISPF Services Guide*.

Panels (option 7.2)

When you are developing panels, you can use the Panels option (7.2) to test newly created or changed panels and messages without having to build supporting code to display them. Any variables referred to and set during panel processing are written to the current function variable pool.

When you select the Panels option (7.2), the panel in Figure 217 on page 385 is displayed.

```

Menu Utilities Compilers Options Status Help
      Dialog Test
  Menu Save Utilities Help
  -----
                Display Panel
Panel name . . . . . _____
Message id . . . . . _____ (Optional)
Cursor field . . . . . _____ (Optional)
Cursor position . . . . . _____ (Optional)
Message pop-up field . . _____ (Optional)

Enter "/" to select option
  Display in window

Command ==>
F1=Help      F2=Split      F3=Exit      F4=Expand
F5=Rfind     F6=Resize     F7=Backward F8=Forward

Option ==> 7
F1=Help      F2=Split      F3=Exit      F7=Backward F8=Forward F9=Swap
F10=Actions  F12=Cancel

```

Figure 217. Display panel (ISPYP1)

Display panel action bar

The Display Panel action bar choices function as follows:

Menu For more information, see the details about the Menu Action Bar Choice in the ISPF User Interface topic in the *z/OS ISPF User's Guide Vol I*.

Save Allows you to specify that you want to save or clear input field information when you exit this panel.

Utilities

For more information, see the details about the Utilities Action Bar Choice in the ISPF User Interface topic in the *z/OS ISPF User's Guide Vol I*.

Help The Help pull-down offers you these choices:

- 1 General
- 2 Display Panel
- 3 Usage Notes
- 4 General Dialog Test

Display panel fields

The fields on the Display Panel function as follows:

Panel name

The name of the panel to be displayed.

Message id

The identifier of a message to be displayed on the panel.

Cursor field

The name of the field on the panel where the cursor is to be positioned.

Panels (option 7.2)

Cursor position

An integer specifying the position in the field where the cursor is to be placed.

Message pop-up field

The name of a panel field the pop-up message window should be placed adjacent to. Note that the message definition determines if the message will appear in a pop-up window.

Display in window

A slash (/) specifies that the panel is to be displayed in a pop-up window.

If you specify a panel name, entries in "Message id", "Cursor field", "Cursor Position", "Message pop-up field", and the Display in window option are optional.

With the exception of the Display in window option, these are the same parameters that a dialog function can specify when calling the DISPLAY service. Selecting the Display in window field is the functional equivalent to the dialog issuing an ADDPOP service before the DISPLAY service.

When the panel is displayed, the)INIT and)PROC sections of the panel are processed in the same way the DISPLAY service would process them.

If you want to set variables before you display the panel, you can use the Variables option (7.3) to do so. When you display the panel, you can type in new data or type over existing data, and then verify the variables by using the Variables option (7.3) again. Data that you type on the panel is retained until you change it, leave Dialog Test, or reset the function pool.

Figure 218 on page 387 shows the panel that is displayed if you specify message ID ISPD241 and, optionally, a cursor position without identifying a panel name. The long message portion of the identified message is displayed when you enter the HELP command on that panel.

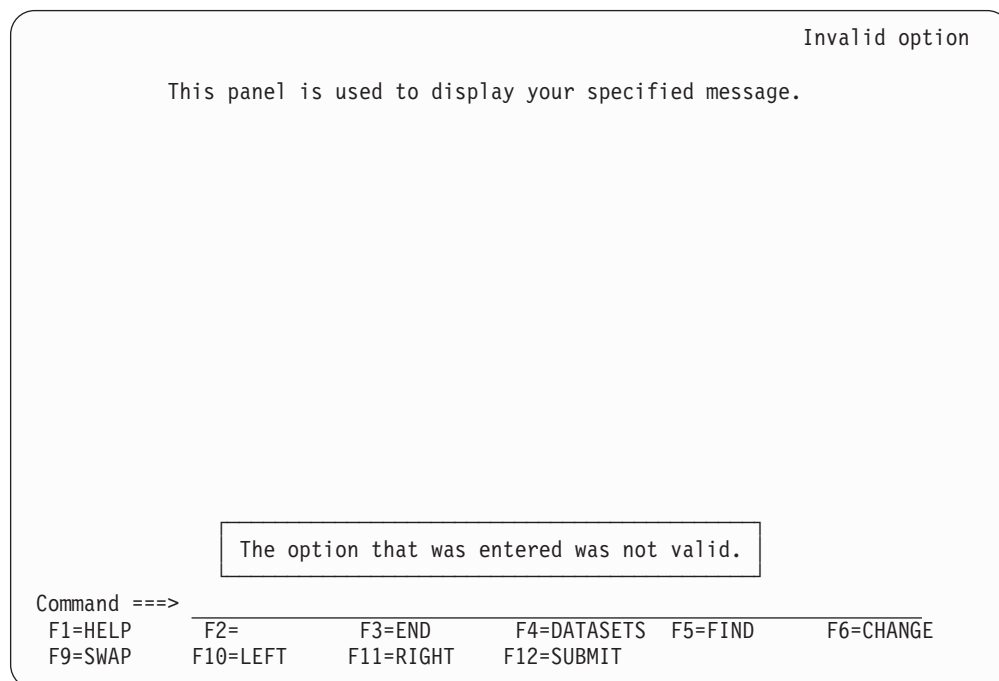

Figure 218. Message display panel (ISPYP2)

When you enter the END command from the panel being tested, the Display Panel reappears on the screen.

Variables (Option 7.3)

The Variables option (7.3) allows you to:

- Display all the ISPF variables defined in the dialog application you are testing.
- Change the value of a variable by typing over it, unless the variable has an N (non-modifiable) attribute.
- Define new variables by inserting lines or by changing the name or pool of a listed variable.
- Delete variable names and blank lines.

When you select this option, you can scroll a display showing all the current variables for the dialog being tested, as shown in Figure 219 on page 388.

In addition to scrolling capability, you can also increase the size of the Variables pop-up window to fill the entire 3270 physical display area using the RESIZE command. The initial RESIZE command increases the pop-up window to its maximum size, and the subsequent RESIZE reduces the window to its original size.

Variables (Option 7.3)

```
Menu Utilities Help
-----
Variables - Application: ISR                      Row 1 to 9 of 707

Add, delete, and change variables. Underscores need not be blanked.
Enter END command to finalize changes, CANCEL command to end without
changes.

Current scrollable width of variables is: 57
Variable P A Value
-----1-----2-----3-----4-----5-----+--
Z          S N
----- ZACCTNUM S N IBMGSA
----- ZAPLCNT  S N 0000
----- ZAPPLID  S N ISR
----- ZBDMXCNT S N 00000000
----- ZCFGCPD  S N 2001/11/22
----- ZCFGCMPT S N
----- ZCFGKSRC S N
----- ZCFGVLV  S N 480R8001

Command ==> Scroll ==> PAGE
F1=Help    F2=Split  F3=Exit    F4=Expand  F5=Rfind   F6=Resize
F7=Backward F8=Forward  F9=Swap    F10=Actions F12=Cancel
```

Figure 219. Variables panel (ISPYVFN)

The Variables display is controlled by the selection you make in the View pull-down on the Dialog Test Primary Option Panel action bar:

- 1 **Display Variables in window.** Variables are displayed in a pop-up window.
- 2 **Display Variables full-screen.** Variables are displayed full-screen.

Note: The current setting is shown as an unavailable choice; that is, it is displayed in blue (the default) with an asterisk as the first digit of the selection number (if you are running in GUI mode, the choice is *grayed*).

Variables panel action bar

The Variables Panel action bar choices function as follows:

Menu For more information, see the details about the Menu Action Bar Choice in the ISPF User Interface topic in the *z/OS ISPF User's Guide Vol I*.

Utilities

For more information, see the details about the Utilities Action Bar Choice in the ISPF User Interface topic in the *z/OS ISPF User's Guide Vol I*.

Help The Help pull-down offers you these choices:

- 1 General Variables
- 2 Definitions
- 3 Variables Panel
- 4 Manipulating Variables
- 5 Primary Commands
- 6 Line Commands
- 7 Usage Notes
- 8 General Dialog Test

Variables panel fields

Each line of the display represents a variable and contains a line command area. The fields on the Variables panel function as follows:

Variable

Name of the variable. The variable name is alphanumeric, with the first character being either alphabetic or one of the special characters \$, #, or @. The variable name cannot be longer than eight characters. All alphabetic characters are converted to uppercase when you press the Enter key. The Variable field is required.

- P** Pool that contains the variable; a required 1-character field, where:
- V** Function pool; the variable was defined with the VDEFINE service.
 - I** Function pool; a variable that was created by a CLIST or REXX exec, or by using the Variables option. This is an *implicit* variable, which was not explicitly defined by using the VDEFINE service.
 - S** Shared variable pool.
 - P** Profile variable pool.
- A** Attributes of the variable, a non-modifiable 1-character field, where:
- N** Non-modifiable variable. Some system-reserved variables are not modifiable.
 - H** Non-modifiable variable containing hexadecimal data. Some system-reserved variables are not modifiable.
 - X** Variable containing hexadecimal data.
 - T** Truncated variable value. The actual value is longer than the 2048 characters that you can display on the expanded panel.

If you change a line showing a truncated value, only the data shown on the display is stored as the new value.
- Value** Value of the variable. The value can be up to 2048 characters in length. Each value is scrollable, by placing the cursor over the value and using the LEFT and RIGHT functions keys. The EXPAND function key can be used to display a full screen of data and display hexadecimal values.

Variables commands

The Variables option (7.3) uses the CANCEL, END, and LOCATE commands, and the I (insert) and D (delete) Dialog Test line commands described in “Commands” on page 377. You can change the displayed sort order using the SORT command. SORT with no operands sorts the list by variable pools then by variable name. SORT NAME sorts the list by variable name and then by variable pool. SORT VALUE sorts the list by the displayed Value field. The LOCATE command can be used to search for a specific variable. LOCATE accepts as an operand the name, or first letters of the name of a variable. If the name is not found, the list is positioned near the closest match. You can use the RFIND key to continue searching other variable pools.

Normally, the variable pools are updated with the data from the display when you use the END command to leave the option.

Manipulating variables

The rows of the display are sorted in this order:

1. By pool (function, then shared, then profile)
2. By function pool type (V, then I)
3. Alphabetically by variable name within each pool.

Variables (Option 7.3)

Insertions are left where they are typed on the display. Changes to the display are processed when you press the Enter key. Updating of the variable pools occurs when you enter the END command.

Creating new variables

You can create new dialog variables, but you cannot create two variables with the same name in the same variable pool.

To create a new variable, you can do one of two things:

- Use the I line command to insert a new row, and then type the variable name, pool, and value on the new line. For each field, move the cursor to the start of the field and type new information. The underscores are pad characters; you do not need to blank them out.
- Type over the name of an existing variable, its pool indicator, or both. This creates a new variable and resets the old variable's value to nulls.

If you change a truncated value, the portion that is not displayed is lost. The new variable value consists only of the visible portion on the screen.

New function pool variables are given an I (implicit) attribute and a CHAR format. If you type F in the attribute field, ISPF changes it to I.

By using the second method, you can interchange the values of two or more variables by simply changing their names. For example, you can interchange the values for variables A and B by changing the variable name A to B and name B to A, and then pressing the Enter key.

Deleting variables

Any dialog variable in the shared and profile pools can be deleted, unless it has an N attribute. Though you cannot delete a variable from the function pool, you can set its value to blanks.

To delete a variable, use the D line command. However, to avoid conflict with the I (insert) line command, the Variables option does not allow you to type a number along with the D command to delete more than one line simultaneously. Therefore, enter a single D line command on each line you want to delete. You can type this command on more than one line before pressing the Enter key.

Variables usage notes

When using the Variables option (7.3), you should be aware of:

Input errors

Correct any errors before leaving a display. If you cannot correct the errors, use the CANCEL command.

Length and format errors in variables defined with the VDEFINE service are detected when you enter the END command. If ISPF finds such an error, it prompts you to fix the variable value.

Test mode

Variable manipulations carried out under Dialog Test at a breakpoint are considered an extension of your dialog and, as such, are handled in user mode. Dialog variables, table data, and service return codes that you introduce, delete, or change are treated as though your dialog had made those changes.

Variable life

Profile variables that you create remain in your profile pool from one Dialog Test session to another. Shared and function variables exist only for the duration of Dialog Test.

Split-screen mode

In split-screen mode, two logical screens can share a profile variable pool. Since the Variables option (7.3) takes a snapshot of the variables, any change to a profile variable on one screen is not immediately reflected on the other screen. To get the latest changes, select the Variables option (7.3) again. Also, when one profile variable is changed on two logical screens using split-screen mode, the changed profile variable on the screen where the last END command was entered takes precedence.

Variable value

Variables defined with the VDEFINE service as non-character are displayed in converted form. Any changes made to the variable's value should conform to the defined format.

Do not change them using the hexadecimal representation. A format or length error causes a message to be displayed when you use the END command. When a VDEFINE error occurs, a panel identifies the data and its value and describes the error. You must then correct the error and press the Enter key. If you create a new variable by changing the pool indicator of an existing variable defined as non-character, the new variable has character (CHAR) format.

Hexadecimal data

Hexadecimal data that cannot be displayed is converted to displayable characters or typed using the form:

```
x'nnnnnnnn'
```

where:

n An integer 0 through 9 or an alphabetic character A through F. There must be an even number of characters within the quotation marks.

DBCS data

A variable defined as DBCS by the VDEFINE service or displayed through the field with FORMAT(DBCS) specified in the test environment is displayed using the form:

```
'-[DBDBDB]'
```

where:

[and]

Represent the SO (shift-out) and SI (shift-in) characters, respectively.

If you type a DBCS value in this format on the Variables panel, only the DBCS characters are stored.

Tables (option 7.4)

The Tables option (7.4) allows you to examine and manipulate the rows of a table, and to display table structure and status. When you select this option, the panel in Figure 220 on page 392 is displayed, on which you show the table function you want and the parameters needed to identify the table.

Tables (option 7.4)

```
Dialog Test
-----
Menu Utilities View Help
-----
Tables
More: +
1 Display row      3 Modify row      5 Display structure
2 Delete row      4 Add row         6 Display status

Table Name . . _____ Open tables . . _____ (NOWRITE or WRITE or
                                                    blank for no TBOPEN)

Row identification:      Current row . :
By row number . . * _____ (* = current row)
Variable Value _____ (Search for row if row number blank)

_____
_____
_____
_____

DBCS column specification:
Option ==>
F1=HELP      F2=      F3=END      F4=DATASETS      F5=FIN
F6=CHANGE    F9=SWAP    F10=LEFT    F11=RIGHT      F12=SUBMIT
```

Figure 220. Tables panel (ISPYTPI)

Tables panel action bar

The Tables panel action bar choices function as follows:

Menu For more information, see the details about the Menu Action Bar Choice in the ISPF User Interface topic in the *z/OS ISPF User's Guide Vol I*.

Utilities

For more information, see the details about the Utilities Action Bar Choice in the ISPF User Interface topic in the *z/OS ISPF User's Guide Vol I*.

View Allows you to select whether the Add row, Modify row, and Display row panels are displayed in pop-up windows. By displaying the panel in a pop-up window, you can see the panel underneath and move the window. By displaying the panel as a full-screen display, you can see more data. The setting you choose will remain in effect until you change it.

Help The Help pull-down offers you these choices:

- 1 General Tables
- 2 Definitions
- 3 Tables Panel
- 4 Display Row
- 5 Delete Row
- 6 Modify Row
- 7 Add Row
- 8 Display Structure
- 9 Display Status
- 10 Usage Notes
- 11 View Action Bar
- 12 General Dialog Test

Tables panel fields

The fields on the Tables panel function as follows:

Table Name

The name of the table in which you are interested. The table must be open for all, except the Display Status option (6) of the Tables option (7.4). The table can be opened using the Dialog Services option (7.6) or can be opened automatically by specifying the Open tables field WRITE/NOWRITE option.

Open tables

The table must be open for all but the Display Status option (6) of the Tables option (7.4). Specifying WRITE or NOWRITE will cause Tables option to automatically open the table in the respective mode. A blank field directs Tables to bypass the automatic open. If Tables automatically opens the table, it will be closed automatically when the Tables option is terminated. This is done with a TBCLOSE service which will cause any table changes to be preserved if the table were automatically opened with the WRITE option.

This field is ignored if the table has been opened outside of the Tables (7.4) option.

Row identification

Identify a row, either directly by row number or indirectly by specifying table variable names and their values as search operands.

Current row

The position number of the current row after you have identified a table. This field is not modifiable.

By row number

The position number of the table row that you want, or, if you are adding a row, you can use:

TOP Makes the new row first in the table.

BOTTOM

Makes the new row last in the table.

Variable

The names of variables whose values are to be used to search the table for a row with matching contents. You insert them by typing over the underscores beneath this heading.

Value The value to be used in the search, up to 54 characters. For an abbreviated search, type the beginning characters followed by an asterisk.

You can specify a DBCS value in the form:

¬[DBDBDB]

where:

[and]

Represent the SO (shift-out) and SI (shift-in) characters, respectively. For an abbreviated search, type a 2-byte asterisk (*) at the end of the DBCS value. For example:

¬[DBDB**]

where ** represents the 2-byte asterisk character.

Tables (option 7.4)

DBCS column specification

The variable names of the values that are DBCS data. The value of the variable is displayed using the form:

¬[DBDBDB]

If you type a DBCS value in this format on the Modify Row panel or the Add Row panel, only the DBCS characters are stored, regardless of the DBCS column specification.

Option

The number of one of the functions displayed on the Tables panel.

Note: The option names (for example, Display row) are point-and-shoot fields; however, if an option is already specified at the Option prompt, it takes precedence over your point-and-shoot selection.

Once you specify a table name, it is retained until you change it or until you leave Dialog Test.

For the Display row (1), Delete row (2), Modify row (3), and Add row (4) options of the Tables option (7.4), you must identify the row you want to display, delete, modify, or add. To do this, you can specify a row number in the “By row number” field, or you can use the Variable and Value fields to specify a list of search operands. To show the current row, leave the asterisk in the “By row number” field. If you specify both a row number and a search operand, the row number is used and the search operand is ignored.

The current row pointer in the table can be changed only at your request or by your dialog.

The list of search operands consists of variable names and values that allow you to specify the values that specific variables have in a row. You can specify the complete value, abbreviate the value with an asterisk to find a row containing a variable beginning with specified characters, or leave the row blank. The search begins with the row following the current row. If a row matching the search operand is not found, the current row pointer is set to the top. You can repeat the search, if necessary.

Tables panel options

Subsequent topics describe the options at the top of the Tables panel.

1—display row

You can use the Display row option to display the contents of an existing row in an open table. When you select the Display row option, perform these tasks on the Tables panel:

- Specify the name of a table in the Table Name field. If the table is not open, specify NOWRITE or WRITE in the “Open tables” field.
- Specify a row number or a search operand list to identify a row.

Note: Use the View action bar choice on the Tables panel to specify whether this display is to be in a pop-up or full-screen.

When you press Enter, you are shown the table row data on a display that you can scroll (Figure 221 on page 395). The pop-up window can also be resized using the

RESIZE command. In the figure, the variables constitute one table row.

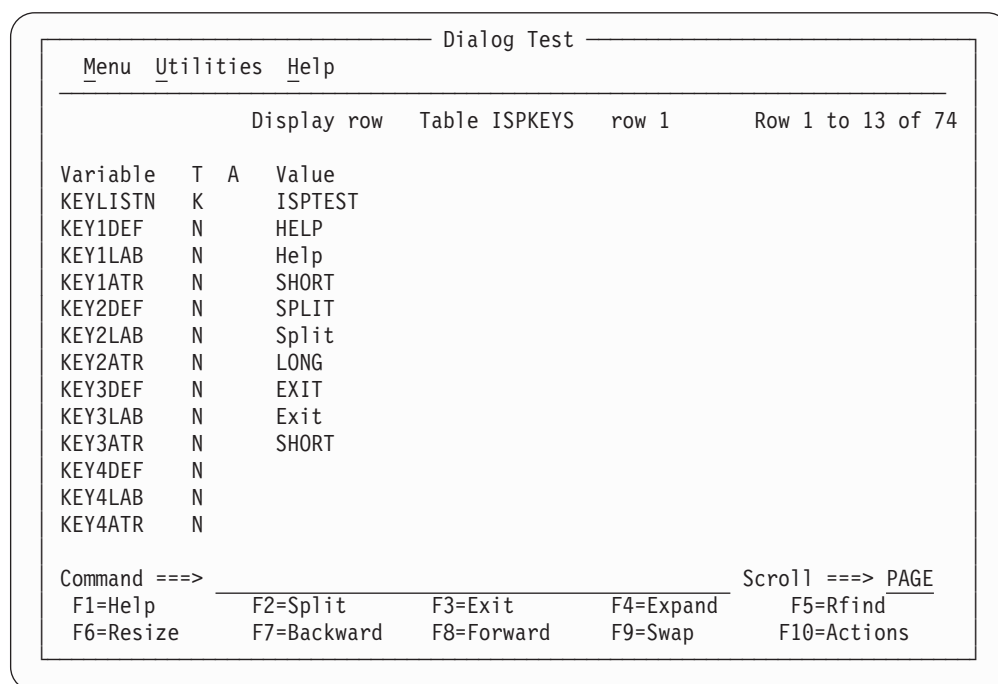

Figure 221. Display row panel (ISPYTPD)

Each line on the display shows:

Variable

Variable name

T Type of variable:

K Key variable.

N Name variable; non-key.

S Save (extension) variable.

A Attribute of each variable:

T Truncated to 58 characters for display.

Value The first 58 characters of the variable value.

Display row commands: The Display Row option uses the END and LOCATE commands described in "Commands" on page 377.

2—delete row

You can use the Delete row option to remove an existing row from an open table. When you select the Delete row option, perform these tasks on the Tables panel:

- Specify the name of a table in the Table Name field. If the table is not open, specify NOWRITE or WRITE in the "Open tables" field.
- Specify a row number or a search operand list to identify a row.

When you press Enter, a panel is displayed (Figure 222 on page 396) to allow you to confirm the delete request.

Tables (option 7.4)

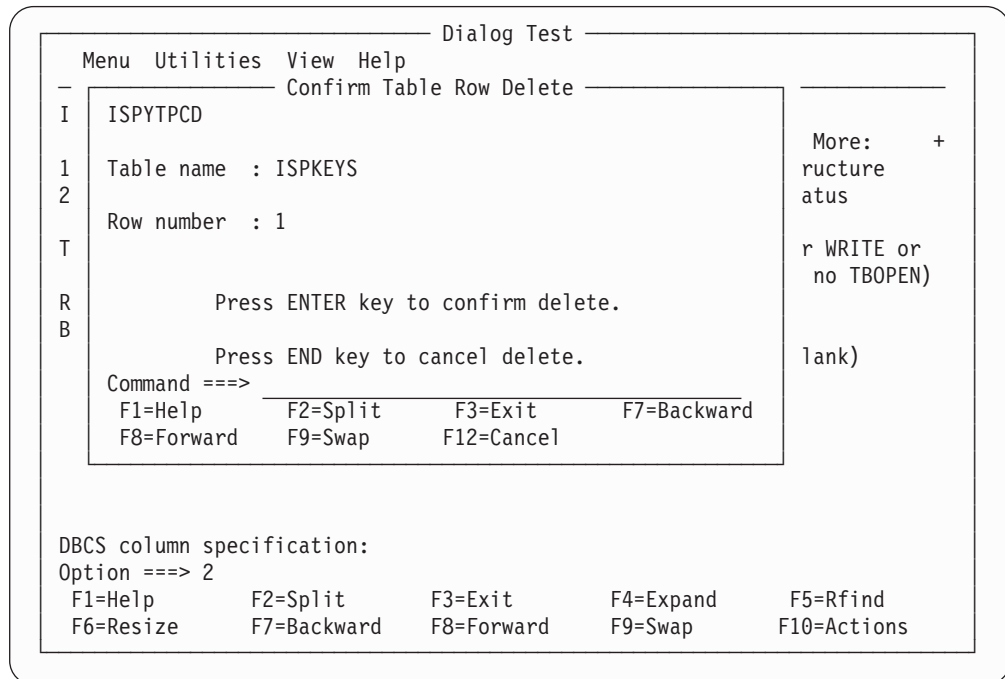

Figure 222. Confirm table row delete panel (ISPYTPCD)

The fields on the panel are:

Table name

Name of an open table

Row number

Number of the row to be deleted.

Press Enter to delete the row, or enter the END or CANCEL command to cancel the deletion.

3—modify row

You can use the Modify row option to change the contents of an existing row of an open table. When you select the Modify row option, perform these tasks on the Tables panel:

- Specify the name of a table in the Table Name field. If the table is not open, specify NOWRITE or WRITE in the “Open tables” field.
- Specify a row number or a search operand list to identify a row.

Note: Use the View action bar choice on the Tables panel to specify whether this display is to be in a pop-up or full-screen.

When you press Enter, a display that you can scroll (Figure 223 on page 397) is shown. The pop-up window can also be resized using the RESIZE command.

```

Dialog Test
-----
Menu Utilities Help
-----
Modify row Table ISPKEYS row 1 Row 1 to 10 of 74

Modify variable values and savenames. Underscores need not be blanked.
Enter END command to finalize changes.

Variable T A Value
-----
KEYLISTN K ISPTST
KEY1DEF N HELP
KEY1LAB N He1p
KEY1ATR N SHORT
KEY2DEF N SPLIT
KEY2LAB N Split
KEY2ATR N LONG
KEY3DEF N EXIT
KEY3LAB N Exit
KEY3ATR N SHORT

Command ==>
F1=Help F2=Split F3=Exit F4=Expand F5=Rfind
F6=Resize F7=Backward F8=Forward F9=Swap F10=Actions
Scroll ==> PAGE

```

Figure 223. Modify row panel (ISPYTPM)

Each line on the panel represents a variable in row 6 of the table and contains a line command field and these fields:

Variable

Variable name, modifiable only for save variables.

T Type of variable, non-modifiable:

K Key variable.
N Name variable; non-key.
S Save (extension) variable.

A Attribute of each variable, non-modifiable:

T Truncated to 2048 characters for display.

Value Value of the variable, up to 2048 characters.

Type in new values or change the current values for the key, name, and save variables in the Value column. Enter new save variables by typing over the underscores in the Name column with the variable names and specifying the desired values. The underscores are pad characters; you do not need to blank them out.

When using the Modify row option, be aware that:

- If the table has keys, the values for the keys in the added row must be different from those in the existing rows when you leave the Modify row option. Otherwise, a message is displayed and the row is displayed again so you can change the keys.
- If the table was sorted using the TBSORT dialog service and a sort field is modified, the row's position in the table can change to preserve the search order.
- You cannot change the variable name for a key variable or name variable; if you do, an error message is displayed and the original name is restored.
- You cannot delete a key or name variable and its value from the display or table row.

Tables (option 7.4)

- If you delete a save variable, assume that the variable no longer exists in this row.
- If more than one variable entry has the same name, all instances of that variable are assigned the value of the last occurrence of the variable; that is, the occurrence closest to the bottom of a display that you can scroll.
- Blank save names are ignored and do not need to be deleted, even if data is left in the value.
- Hexadecimal data that usually cannot be displayed is converted to characters that can be displayed or is typed by using the form:
`X'nnnnnnnn'`
where:
n An integer 0-9 or an alphabetic character A-F. There must be an even number of characters within the quotation marks.
- Variables defined with the VDEFINE service as non-character are shown in converted form; do not change them by using the hexadecimal representation. A format or length error causes a message to be displayed when you use the END command.
- When you leave the Modify row option by using the END command, the row is replaced, and the message Row modified is issued.

Modify row commands: The Modify row option uses the CANCEL, END, and LOCATE commands, and the D (delete), I (insert), and R (repeat) Dialog Test line commands described in “Commands” on page 377. Inserted and repeated lines always have a type of S, because only save variables can be added to (or deleted from) a row of an existing table.

4—add row

You can use the Add row option to add a new row after a selected row of an opened table. When you select the Add row option, perform these tasks on the Tables panel:

- Specify the name of a table in the Table Name field. If the table is not open, specify NOWRITE or WRITE in the “Open tables” field.
- Specify a row number or a search operand list to identify a row.

Note: Use the View action bar choice on the Tables panel to specify whether this display is to be in a pop-up or full-screen.

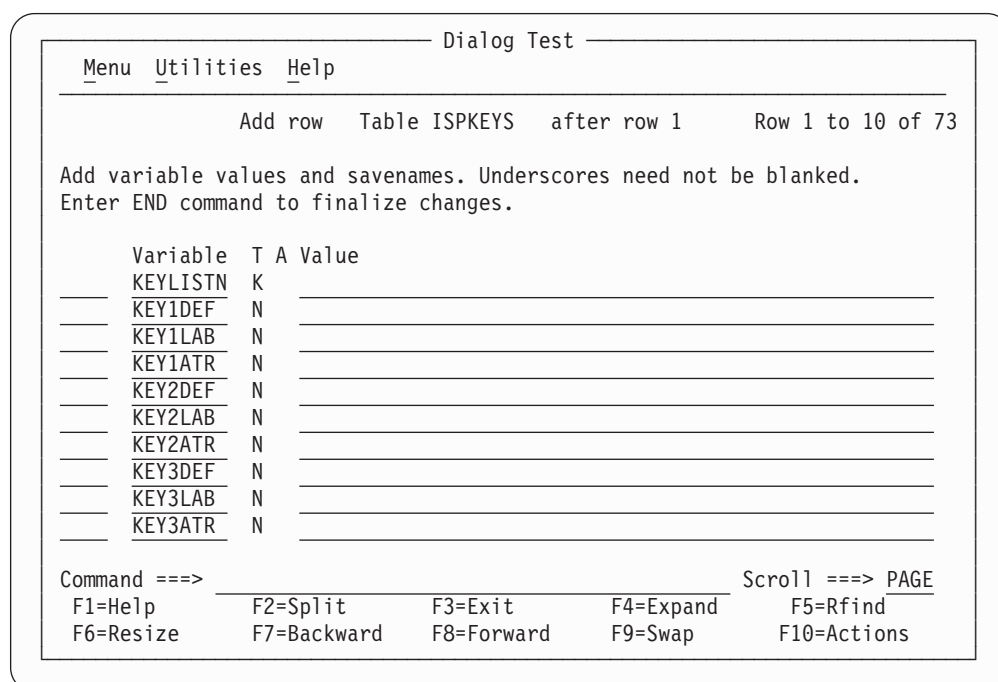

Figure 224. Add row panel (ISPYTPA)

When you press Enter, a scrollable display is shown (Figure 224), containing all the key and name variables in the table. The pop-up window can also be resized using the RESIZE command.

Each row of the display contains a line command field and these fields:

Variable

Variable name.

T Type of variable, non-modifiable:

K Key variable.

N Name variable; non-key.

S Save (extension) variable.

A Attribute of each variable. This attribute is non-modifiable and is not used for this option.

Value Space for the variable value to be added, up to 2048 characters.

Type the values for the key and name variables in the Value column, which is originally initialized to all nulls. You cannot change the names of the key and name variables because they were established when the table was created.

You can enter save variables, identified as TYPE S, by typing over the underscores with the save variable names and specifying the desired values. The underscores are pad characters; you do not need to blank them out.

You can add a row with no values to the table, but you are asked to confirm such an action to guard against inadvertent use of the END command.

When using the Add row option, be aware that:

Tables (option 7.4)

- The position of the new row in the table depends on whether the table was previously sorted using the TBSORT dialog service. If the table was sorted, the new row is placed in sort order; if it has not been sorted, the new row is placed after the row you specified.
- You cannot delete a key or name variable and its value from the display or table row.
- You cannot change the variable name for a key or name variable; if you do, an error message is displayed and the original name is restored.
- If more than one variable entry has the same name, all instances of that variable are assigned the value of the last occurrence of the variable; that is, the occurrence closest to the bottom of the display that you can scroll.
- If the table has keys, the values for the keys in the added row must be different from those in all the existing rows when you leave the Add Row option. Otherwise, a message is displayed and the row is displayed again so you can change the keys.
- Blank save names are ignored and do not need to be deleted, even if data is left in the value.
- Hexadecimal data that usually cannot be displayed is converted to characters that can be displayed or is typed by using the form:
`X'nnnnnnnn'`
where:
 - n** An integer 0-9 or an alphabetic character A-F. There must be an even number of characters within the quotation marks.
- Variables defined with the VDEFINE service as non-character are shown in converted form; do not change them by using the hexadecimal representation. A format or length error causes an error message to be displayed when you use the END command.

Add row commands: The Add row option uses the CANCEL, END, and LOCATE commands, and the D (delete), I (insert), and R (repeat) Dialog Test line commands described in “Commands” on page 377. Inserted and repeated lines always have a type of S, because only save variables can be added to (or deleted from) a row of an existing table.

5—display structure

When you select the Display structure option on the Tables panel, you are shown a display of the table structure for the table specified in the Table Name field. You can scroll this display (Figure 225 on page 401) using the scroll commands. The table name appears in the panel header.

```

Dialog Test
-----
Menu Utilities Help
-----
ISPYTPSR                Structure of Table ISPKEYS                Row 1 to 8 of 17

Number of keys . . . : 1                Number of rows . . . : 7
Number of names . . : 72                Current row pointer . : 1
KEYS:    KEYLISTN

NAMES:   KEY1DEF    KEY1LAB    KEY1ATR    KEY2DEF    KEY2LAB
         KEY2ATR    KEY3DEF    KEY3LAB    KEY3ATR    KEY4DEF
         KEY4LAB    KEY4ATR    KEY5DEF    KEY5LAB    KEY5ATR
         KEY6DEF    KEY6LAB    KEY6ATR    KEY7DEF    KEY7LAB
         KEY7ATR    KEY8DEF    KEY8LAB    KEY8ATR    KEY9DEF
         KEY9LAB    KEY9ATR    KEY10DEF   KEY10LAB   KEY10ATR

Command ==> _____ Scroll ==> PAGE
F1=HELP      F2=      F3=END      F4=DATASETS  F5=FINN
F6=CHANGE    F9=SWAP    F10=LEFT    F11=RIGHT    F12=SUBMIT

Option ==> 7
F1=Help      F2=Split    F3=Exit     F7=Backward  F8=Forward  F9=Swap
F10=Actions  F12=Cancel

```

Figure 225. Structure of table panel (ISPYTPSR)

The display contains these fields:

Number of keys

Number of key variables in a row.

Number of names

Number of name variables in a row.

Number of rows

Number of rows currently in the table.

Current row pointer

Current row pointer value.

KEYS A list of the names of all the key variables.

NAMES

A list of the names of all the name variables.

Display structure command: The KEYS and NAMES lists can be scrolled, and you can use the LOCATE command to find a specific variable name. See “Finding a character string” on page 379 for information about its use.

6—display status

If you select the Display status option from the Tables panel, one of two data information panels is displayed for the table specified in the Table Name field. The information reflects all operations using the specified table, including those done at your request by the Tables options under Dialog Test.

Table not open: If the table is not open for your user ID, you are shown a Status of Table panel (Figure 226 on page 402) with the value NOT OPEN in the “Status for this screen” field.

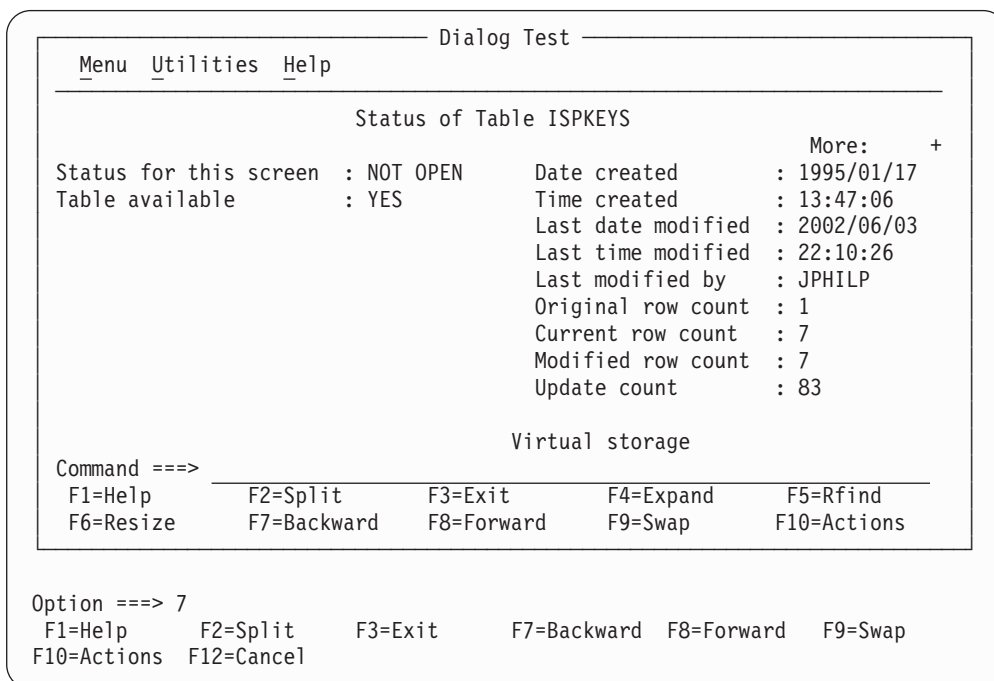

Figure 226. Status of table panel with table not open (ISPYTPS1)

The panel contains these fields:

Status for this screen

Shows that the table is NOT OPEN for this logical screen.

Table available

YES or NO; whether you can open the table.

Date created

Date the table was created; shown in national format.

Time created

Time the table was created.

Last date modified

Date the table was last modified; shown in national format.

Last time modified

Time the table was last modified.

Last modified by

User ID of the user who last changed the table.

Original row count

The number of rows that were added to a newly created table before closing the table for the first time.

Current row count

The number of rows currently in the table.

Modified row count

The number of rows in the table that have been changed at least once. A row that has been added to an existing table is also considered a changed row.

Update count

Number of times the table has been modified. One or more updates during any table open or close sequence increments this counter by one.

Virtual storage

The number of bytes of virtual storage required by the table when it is open.

The Modify row option on the Tables panel allows you to change a key of a keyed table by adding the new row and deleting the old row. The row counts thus reflect this processing when changing a key value.

Table open: If the table is open for your user ID, you are shown a Status of Table panel (Figure 227) with the value OPEN in the Status for this screen field.

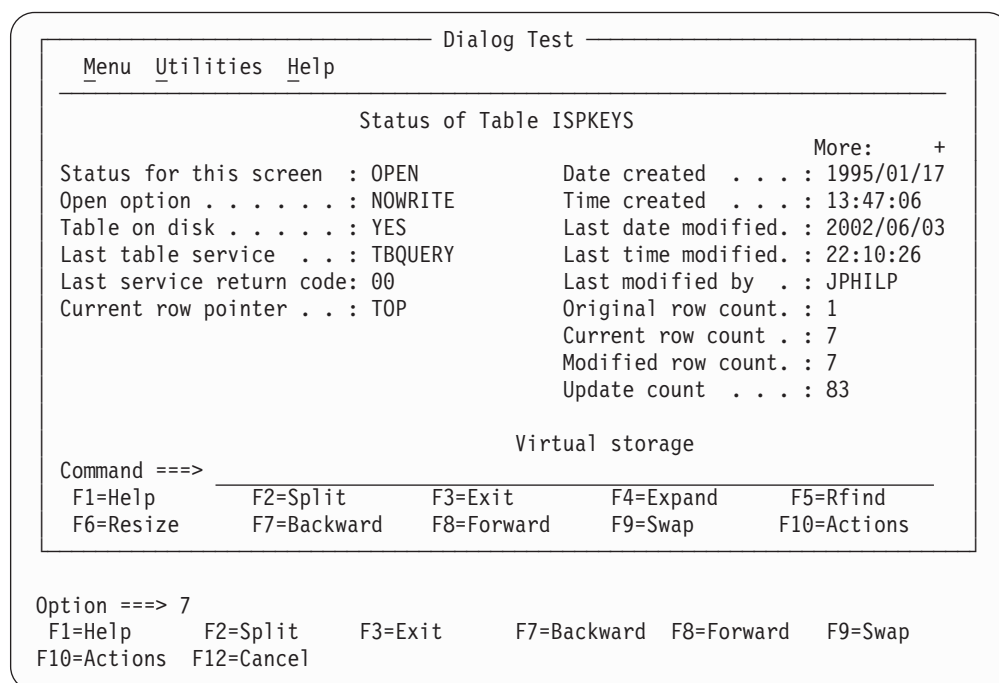

Figure 227. Status of table panel with table open (ISPYTPS1)

This panel contains these fields:

Status for this screen

Shows that the table is OPEN for this logical screen.

Open option

Option used to open the table; this value can be WRITE, NOWRITE, SHR WRITE, or SHR NOWRITE.

Table on disk

Whether the table has been saved on disk; this value can be YES or NO.

Last table service

Name of the last table service called.

Last service return code

Last table services return code.

Current row pointer

Current position in the table.

Date created

Date the table was created; shown in national format.

Tables (option 7.4)

Time created

Time the table was created.

Last date modified

Date the table was last modified; shown in national format.

Last time modified

Time the table was last modified.

Last modified by

User ID of the user who last changed the table.

Original row count

The number of rows that were added to a newly created table before closing the table for the first time.

Current row count

The number of rows currently in the table.

Modified row count

The number of rows in the table that have been changed at least once. A row that has been added to an existing table is also considered a changed row.

Update count

Number of times the table has been modified. One or more updates during any table open or close sequence increments this counter by one.

Virtual storage

The number of bytes of virtual storage required by the table.

The Modify row option on the Tables panel allows you to change a key of a keyed table by adding the new row and deleting the old row. The row counts thus reflect this processing when changing a key value.

Log (option 7.5)

The Log option (7.5) allows you to display and browse data recorded in the ISPF transaction log, as shown in Figure 228 on page 405.

```

Browse log - USERID.SPFL0G2.LIST                               Line 00000000 Col 007 086
***** Top of Data *****
Time                *** ISPF transaction log ***                Userid:

09:03  Start of ISPF Log - - - - Session # 16 -----
10:15   TSO      - Command - - SUBMIT NOTIFY
10:37   ***** Dialog Error ***** - Application(ISR); Function Module (ISR@USER);
10:37   Line from panel:      - )BODY EXPAND(//) WIDTH(&ZWIDTH) CMD(ZCMD)
10:37   Panel 'ISPYLP1' error - Invalid WIDTH value, (must be numeric chars,
***** Bottom of Data *****

```

```

Command ==>>
F1=HELP      F2=          F3=END      F4=DATASETS  F5=FOUND     F6=CHANGE
F9=SWAP      F10=LEFT   F11=RIGHT  F12=SUBMIT

```

Figure 228. ISPF transaction log (ISPYLP1)

You can use all the Browse commands, except BROWSE, while looking at the ISPF log.

ISPF transaction log not available

Sometimes the log is not available for browsing. This can occur when:

- The log data set is empty.
- The log data set was not created for this session because 0 was entered in the “Primary pages” field on the Log Set Defaults and List Set Defaults pop-ups, which can be reached by selecting Option 0 from the ISPF Primary Option Menu and then selecting the Log Data set defaults and List Data set defaults choices from the Log/List pull-down.
- No data has been written to the log during this session, and although the log data set exists and is not empty, you did not end the last ISPF session normally; for example, an abend can have ended the session. You can browse the log if you take an action that causes a log entry to be written.
- The log data set was previously allocated with a disposition of OLD. It must be allocated with a disposition of MOD.
- The log data set has been previously allocated to SYSOUT.

Trace output in ispf log

This trace output is written to the ISPF log:

- Trace header entries
- Function trace entries
- Variable trace entries.

Each type of entry follows the format of other log entries: a short summary on the left, and a detailed entry on the right.

Trace header entries

The first line of trace data is a trace header that identifies the trace and shows the current application ID, the current function, and the current screen. For split-screen mode, the original screen is 1 and the screen generated by the SPLIT command is 2. The summary section of the header entry identifies the entry as a dialog trace. The trace header entry is written during the test session whenever a function or variable trace entry is to be written for an application, function, or screen that differs from the last.

For example, a trace of logical screen 1 of function TESTF1 in application ISR would place this line in the ISPF log:

```
DIALOG TRACE ---- - APPLICATION(ISR) FUNCTION(TESTF1) SCREEN(1)
```

Function trace entries

A pair of function trace entries, a BEGIN entry and an END entry, is generated during a function trace for each traced dialog service that is called. A service can be called from a user dialog that is currently processing, or from a Dialog Test action for the user. The summary portion of each of these entries shows the name of the dialog service, whether it is the beginning or the end of its processing, and whether it was called indirectly from a Dialog Test panel. If the word TEST does not appear, the user dialog called the service directly. For END entries, the service return code is shown on a second line.

The detailed section of the log entries contains an image of the service call and the parameters used to call that service, using two lines if necessary. For example:

```
DISPLAY .. BEGIN ... TEST - DISPLAY PANEL(XYZ)
:
:
DISPLAY .. END... ... TEST - DISPLAY PANEL(XYZ)
  ..RETURN CODE (0)
```

There can be many log entries between the begin and end entries. For example, any active variable traces can cause log entries during a SELECT trace.

Note these aspects about the service call image:

- The image is truncated after the second line.
- ISPEXEC calls are shown as typed in the dialog.
- ISPLINK and ISPLNK calls (except for the ISREDIT service) are displayed with their parameter values separated by commas. Name-lists are shown as typed in the dialog, in either string or structure format. Structure format includes the count, element length, and list of names. For a variable services parameter whose context is defined by the name-list parameter on the service call, the first four bytes of the parameter value are displayed in hexadecimal format (X'nnnnnnnn').
- Dialog Test calls are shown using the command call format without the ISPEXEC prefix.

Variable trace entries

Two variable trace entry lines are generated for each variable trace log entry. The variable can be referred to or set by a user dialog directly or indirectly by a dialog service, or explicitly set by a Dialog Test option for a user. The summary parts of these entry lines identify the trace. Line one shows the name of the variable, the pool that contains it (F for function, S for shared, P for profile), and an indicator (TEST) if a Dialog Test option set the value. Line two shows the operation done for the variable (GET, PUT, or CHG) and the name of the dialog service that did the operation for non-TEST entries.

The current value of the variable is printed in the detail section of the log entry and can span two lines. For example:

```
LIB1.... POOL(P) .... - VALUE(FLAG)
...GET by EDIT      -
```

The value is truncated after the second line.

If the variable value contains characters that cannot be displayed, the value is displayed in hexadecimal format (X'nnnnnnnn').

Dialog services (option 7.6)

The Dialog Services option (7.6) allows you to call a dialog service by entering the service call with or without the ISPEXEC characters.

Figure 229 shows the Invoke Dialog Service panel.

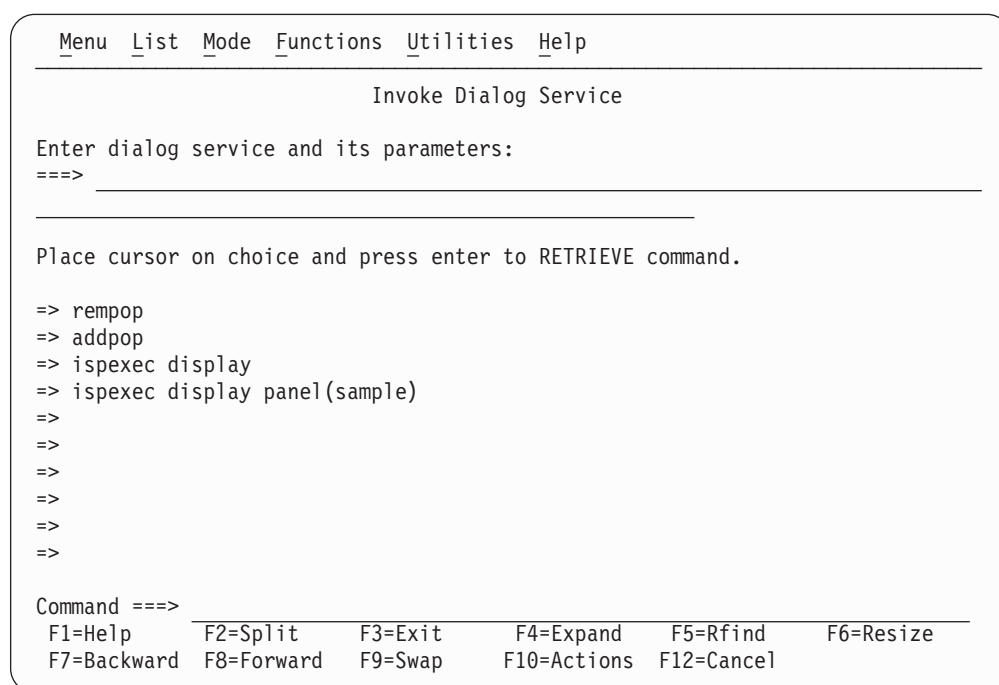

Figure 229. Invoke dialog service panel (ISPLINK)

On this panel, if you want to display panel XYZ, enter:

```
====> DISPLAY PANEL(XYZ)
```

or

```
====> ISPEXEC DISPLAY PANEL(XYZ)
```

The service is called when you press the Enter key. You are informed of the service's completion and return code.

You can call any dialog service that is valid in the command environment except CONTROL at a breakpoint or before calling a function.

The Invoke Dialog Service panel has a saved command area (the bottom portion of the screen) that contains a list of up to 10 commands that you have saved. These

Dialog services (option 7.6)

commands are point-and-shoot fields. The mode you specify from the Mode pull-down menu on the action bar determines what happens when you select a command.

Invoke dialog service panel action bar

The Invoke Dialog Service panel action bar choices function as follows:

Note: The Invoke Dialog Service panel action bar contains three pull-down choices that let you control the saved command area.

- List
- Mode
- Functions.

Menu For more information, see the details about the Menu Action Bar Choice in the ISPF User Interface topic in the *z/OS ISPF User's Guide Vol I*.

List The List pull-down offers you these choices:

Note: The current setting is shown as an unavailable choice; that is, it is displayed in blue (the default) with an asterisk as the first digit of the selection number (if you are running in GUI mode, the choice will be *grayed*).

Update On

Makes the list of commands in the saved command area *live*; that is, new commands are appended to the list automatically.

Update Off

Makes the list of commands in the saved command area *static*; that is, new commands are not appended to the list automatically.

Mode The Mode pull-down offers you these choices:

Note: The current setting is shown as an unavailable choice; that is, it is displayed in blue (the default) with an asterisk as the first digit of the selection number (if you are running in GUI mode, the choice will be *grayed*).

Retrieve

Allows commands to be retrieved from the saved command area and placed on the TSO Command Entry field (==>) so that you can edit them before they are executed. This mode is the default.

Execute

Allows commands to be retrieved from the saved command area and executed in one step.

Delete Allows you to delete commands from the saved command area without executing the commands. Place the cursor on the command to be deleted and press Enter. The command will be blanked out.

Functions

The Functions pull-down offers you this choice:

Note: The choice is unavailable when you initially enter the panel and after you compress the list; that is, it will display in blue (the default) with an asterisk as the first digit of the selection number (if you are running in GUI mode, the choice will be *grayed*).

Compress List

Compresses the saved command area by removing deleted entries.

Utilities

For more information, see the details about the Utilities Action Bar Choice in the ISPF User Interface topic in the *z/OS ISPF User's Guide Vol I*.

Help The Help pull-down offers you these choices:

- 1 General
- 2 General Dialog Test

Special display panel

If you issue the DISPLAY service call with only a message parameter, or with no parameter at all, the Special Display Panel is shown (Figure 230).

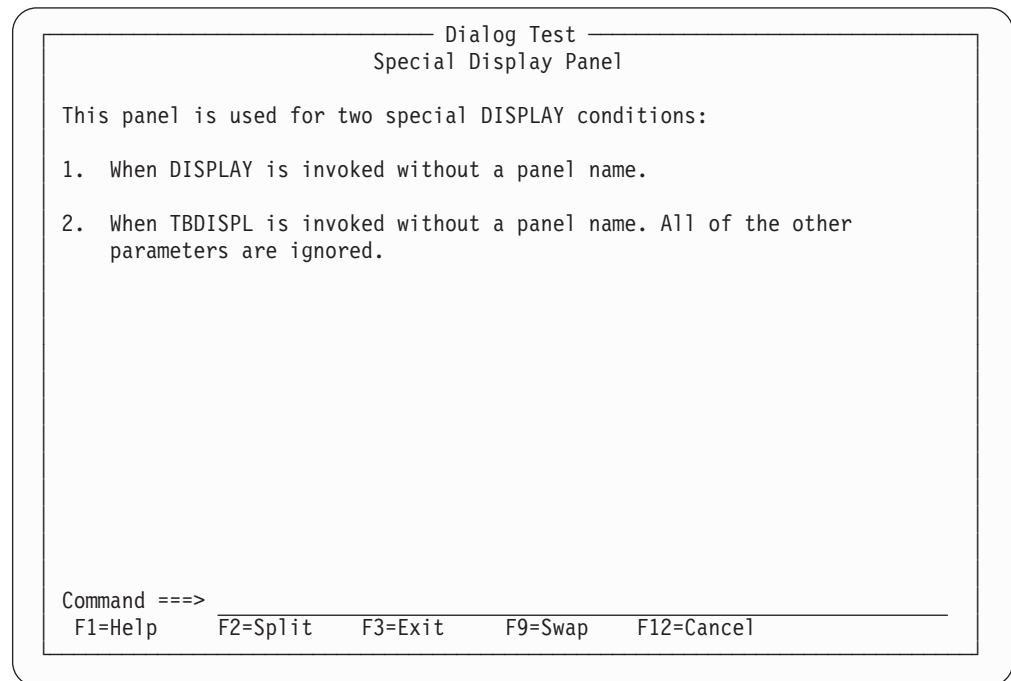

Figure 230. Special display panel (ISPYS2)

Traces (option 7.7)

The Traces option (7.7) allows you to define, change, and delete trace specifications. You can trace processed dialog services, except for the VPUT or VGET service issued from a panel, and dialog variables to which are referred during dialog processing. Trace data is placed in the transaction log, where you can browse it by using the Log option (7.5) or print it when you leave ISPF. You can also print the log data set during an ISPF session by using the ISPF LOG command.

Since tracing can degrade dialog performance and create large amounts of output, you should be careful in setting the scope of trace definitions.

When you select this option, a selection panel is displayed (Figure 231 on page 410) on which you can show the type of trace you want to define.

Traces (option 7.7)

```
Menu Utilities Compilers Options Status Help
- Dialog Test -
  Menu Utilities Help
  _____
0          Traces                               : SUEBURN
1                                               : 11:00
2  1 Function Traces  Monitor dialog service calls : 3278
3  2 Variable Traces  Monitor dialog variable usage : 1
4                                               : ENGLISH
5 Option ==> _____                       : ISR
6 F1=Help           F2=Split           F3=Exit           F4=Expand         : ISPF
7 F5=Rfind          F6=Resize          F7=Backward       F8=Forward        : SUEBURN
9                                               : MVS8
10 SCLM             SW Configuration Library Manager   MVS acct. : IBMGSA
11 Workplace        ISPF Object/Action Workplace     Release . : ISPF 5.9
12 z/OS System      z/OS system programmer applications
13 z/OS User        z/OS user applications

      Enter X to Terminate using Log/List defaults

Option ==> 7
F1=Help   F2=Split   F3=Exit   F7=Backward F8=Forward F9=Swap
F10=Actions F12=Cancel
```

Figure 231. Traces panel (ISPYR11)

Subsequent topics describe the options shown at the top of the Traces panel.

1—function traces

The Function Traces option on the Traces panel is used to establish criteria for recording the names of dialog service calls, the service parameters, and return code in the ISPF log. If either a dialog or Dialog Test processing causes a service call, that call is recorded in the trace. An example of Dialog Test processing that causes a service call is the use of the Panels option (7.2) to display a panel. Whenever a new application or function causes data to be recorded, a header is placed in the trace.

When you select the Function Traces option, you are shown a panel that you can scroll (Figure 232 on page 411). The pop-up window can also be resized using the RESIZE command. The panel lists all currently defined function traces.

You can add, delete, and change function trace definitions by using this panel, either before calling a function or at a breakpoint.

```

      _____ Function Traces _____
      Menu Utilities Help
      _____
                                     Row 1 to 7 of 13
      Add, delete, and change traces. Underscores need not be blanked.
      Enter END command to finalize changes.

      Function      Active      Dialog services to be traced
      (Required)   (YES,NO)   (No entry=all)
                  (No entry=YES) ("OR" is assumed between names)

      _____  _____  _____
      ALL          NO
      _____  _____  _____
      _____  _____  _____
      _____  _____  _____
      _____  _____  _____
      _____  _____  _____
      _____  _____  _____

      Command ==> _____ Scroll ==> PAGE
      F1=Help      F2=Split      F3=Exit      F4=Expand      F5=Rfind
      F6=Resize    F7=Backward   F8=Forward   F9=Swap        F10=Actions
  
```

Figure 232. Function traces panel (ISPYRFP)

Each line defines a function trace, showing a line command area and these fields:

Function

The name of the user function that should contain the trace, or ALL to trace every dialog function. Initially, ALL is presented on the display but is not started. Change the NO to a YES in the Active column to start such a trace. If you want to trace a function whose name is ALL, enclose the name in single quotes to distinguish it; that is, type 'ALL', not ALL.

Active Whether the trace is to be active now:

YES The trace is currently active.

NO The trace is currently not active.

Blank The trace is currently active.

Dialog services to be traced

Names of dialog services to be traced. No entry in this field shows all calls to dialog services for the function are to be traced.

All function traces exist until you leave Dialog Test, or until you delete them from this panel. Enter new information by typing over the existing data. The underscores are pad characters to show the starting and ending positions for each field; you do not need to blank them out. You can create several function traces before you press the Enter key.

During dialog processing, to determine whether the criteria for a function trace have been met, Dialog Test processes a logical AND of the Function, Active, and Dialog services fields specified for that function trace. Dialog Test also processes a logical OR within the Dialog services field to determine whether a particular dialog service has been matched. Therefore, if you want more than one trace for a function, you should create multiple rows.

Function traces commands

The Function Traces option uses the CANCEL, END, and LOCATE commands, and the D (delete), I (insert), and R (repeat) Dialog Test line commands described in "Commands" on page 377.

2—variable traces

The Variable Traces option on the Traces panel is used to establish criteria for recording variable usage. A variable's usage is recorded if an ISPF service is directly asked to operate on the variable (such as VGET, VPUT, and VCOPY), or if an ISPF service is indirectly asked to operate on the variable (such as DISPLAY). Variables changed under the Variables option (7.3) are also recorded if the trace specifications are met.

When you select the Variable Traces option, you are shown a display that you can scroll (Figure 233). The pop-up window can also be resized using the RESIZE command. The display lists all currently defined variable traces. You can add, delete, and change variable trace definitions at a breakpoint, or by using this panel before calling a function.

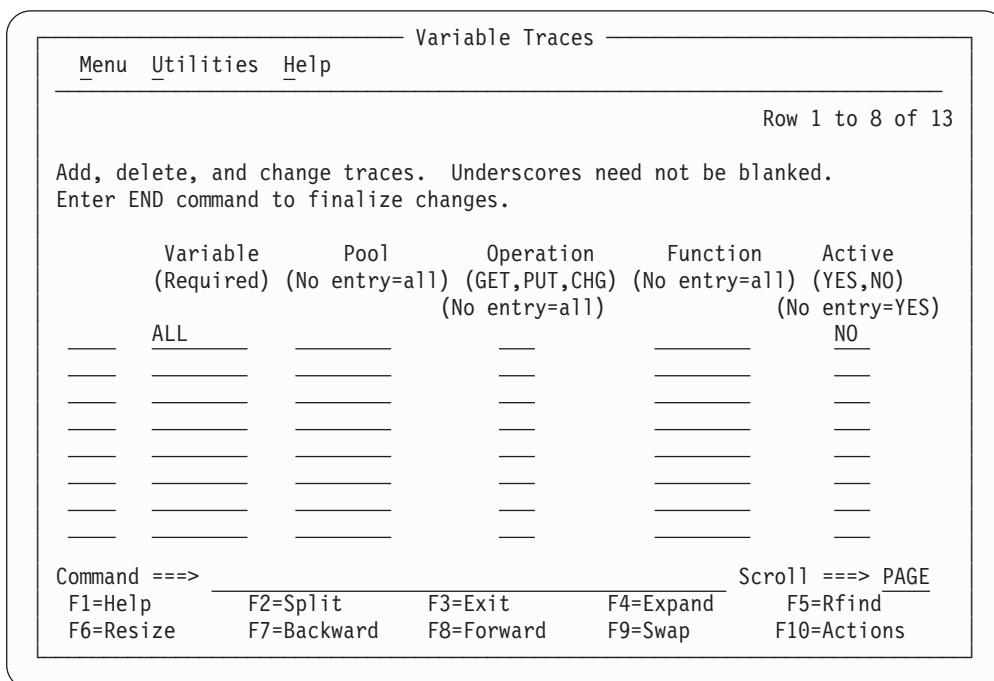

Figure 233. Variable traces panel (ISPYRVP)

Each line defines a variable trace, showing a line command area and these fields:

Variable

Name of the variable to be traced, or ALL to show tracing of all variables. Initially, ALL is presented on the display but is not started. Change the NO in the Active column to YES to start such a trace. If you want to trace a variable whose name is ALL, enclose that name in single quotes to distinguish it; that is, type 'ALL', not ALL.

Pool

- F** Function variable pool.
- S** Shared variable pool.
- P** Profile variable pool.
- Blank** All pools.

Operation

Type of variable reference to trace:
GET Accesses to the variable's value.
PUT Stores to the variable's value.
CHG Changes to the variable's value.
Blank All references to variable are traced.

Function

If there is no entry, this variable is traced for all functions.

Active Indication of whether the trace is to be active:

YES The trace is currently active.
NO The trace is currently not active.
Blank The trace is currently active.

All variable trace definitions exist until you leave Dialog Test, or until you delete them from this panel. Enter new information by typing over the existing data. The underscores are pad characters to show the start and end of each field; you do not need to blank them out. You can create several variable traces before you press the Enter key.

During dialog processing, to determine whether the criteria for a variable trace have been met, Dialog Test processes a logical AND of the Variable, Pool, Operation, Function, and Active fields specified for that variable trace. Therefore, if you want more than one trace for a variable, you should create multiple rows.

Variable traces commands

The Variable Traces option uses the CANCEL, END, and LOCATE commands, and the D (delete), I (insert), and R (repeat) Dialog Test line commands described in "Commands" on page 377.

Breakpoints (option 7.8)

A *breakpoint* is a location at which the processing of your dialog is suspended so that you can use Dialog Test facilities. The Breakpoints option (7.8) allows you to show where such temporary suspensions should occur. At a breakpoint, you can examine and manipulate dialog data such as tables and variables. You can also specify new test conditions, such as traces and other breakpoints.

Breakpoints are located immediately before a dialog service receives control or after it relinquishes control. Breakpoint definitions cause special handling within the ISPLINK, ISPLNK, or ISPEXEC interfaces to dialog services; no user dialog code is modified. When the criteria for a breakpoint are satisfied, your dialog is suspended. You can then do any of the functions shown on the Breakpoint Primary Option Panel. You cannot use as a breakpoint the VPUT or VGET service issued from a panel, nor will breakpoints occur for selections from a menu (selection) panel. Breakpoints occur only for dialog service calls that use the ISPLINK, ISPLNK, or ISPEXEC interfaces.

Along with several menu bar items common across ISPF Version 4.1, the Breakpoints panel has added the Qualify pull-down. You can now display the qualification parameter values from the Breakpoints panel in two ways:

- Enter the QUAL primary command
- Select the Qualifications choice from the Qualify pull-down.

Breakpoints (option 7.8)

The Function and Active columns are overlaid with a column of data titled Qualification Parameter Values; this column was logically off the screen to the right of the first Breakpoints panel. To resume the format of the Breakpoints panel, you can either:

- Enter the RESUME primary command, or
- Select the Breakpoints choice from the Qualify pull-down

Specifying breakpoints

When you select the Breakpoints option, you are shown a display that you can scroll (Figure 234). The pop-up window can also be resized using the RESIZE command. The display lists all currently defined breakpoints for this session. You can use this panel to add, delete, or change breakpoint definitions, either before calling a function or at a breakpoint.

Dialog Test

Menu Qualify Utilities Help

Breakpoints Row 1 to 5 of 13

Add, delete, and change breakpoints. Underscores need not be blanked.
Enter END command to finalize changes.

Service (Required)	When (BEFORE,AFTER,Rnn) (No entry=all)	Function (No entry=all)	Active (YES,NO) (No entry=YES)
_____	_____	_____	_____
_____	_____	_____	_____
_____	_____	_____	_____
_____	_____	_____	_____
_____	_____	_____	_____

Command ==> _____ Scroll ==> PAGE

F1=Help F2=Split F3=Exit F4=Expand F5=Rfind
F6=Resize F7=Backward F8=Forward F9=Swap F10=Actions

F1=Help F2=Split F3=Exit F7=Backward F8=Forward F9=Swap
F10=Actions F12=Cancel

Figure 234. Breakpoints panel (ISPYBP1)

Breakpoints panel action bar

The Breakpoints panel action bar choices function as follows:

Menu For more information, see the details about the Menu Action Bar Choice in the ISPF User Interface topic in the *z/OS ISPF User's Guide Vol I*.

Qualify

Displays the Qualification parameter values field on the Breakpoints panel so that you can further constrain the conditions under which a breakpoint is to occur.

Utilities

For more information, see the details about the Utilities Action Bar Choice in the ISPF User Interface topic in the *z/OS ISPF User's Guide Vol I*.

Help The Help pull-down offers you these choices:

- 1 General
- 2 Definitions
- 3 Breakpoints Panel

4	Qualification Panel
5	Line Commands
6	Primary Commands
7	Usage Notes
8	General Dialog Test

Breakpoints panel fields

Each line defines a breakpoint and includes a line command area and these fields:

Service

Name of the dialog service at which to interrupt dialog processing. This field is required.

When Indication of when the breakpoint should occur:

BEFORE

Before the service receives control.

AFTER

After the service finishes processing.

Rnn After the service finishes processing, but only if the return code is the integer *nn*.

Blank Before and after service processing.

Function

The program function or command function that must be processing for the breakpoint to be taken. No entry in this field shows that the breakpoint can occur for all functions.

Active Indication of whether the breakpoint is to be active now:

YES It is currently active.

NO It is currently not active.

Blank It is currently active.

QUAL

If present at the end of a row, shows that qualification data exists for the breakpoint. This field is non-modifiable. See "Qualification parameter values" for additional information.

All input fields contain underscores. Empty lines are added to the first display to fill up the screen. If you delete all the lines used for defining breakpoints, the display is automatically refreshed with enough empty lines to fill the screen again.

All breakpoints exist until you end or cancel your Dialog Test session, or until you delete them from this panel. Enter new information by typing over the existing data. The underscores are pad characters to show the starting and ending positions for each field; you do not need to blank them out. You can create several breakpoints before you press the Enter key.

Breakpoints commands

From the Breakpoints panel, you can use the CANCEL, END, LOCATE, QUAL, and RESUME commands, and the D (delete), I (insert), and R (repeat) Dialog Test line commands described in "Commands" on page 377.

Qualification parameter values

A different part of the Breakpoints panel allows you to further constrain the conditions under which a breakpoint is to occur by entering qualification

Breakpoints (option 7.8)

parameter values. On this part of the panel, you can list parameter data with which the named service must have been called.

The Breakpoints panel with the Qualification parameter values field is displayed (Figure 235) if you enter the QUAL primary command on the first part of the Breakpoints panel or if you select the Qualifications choice from the Qualify pull-down. The Function and Active columns are overlaid with a column of data titled Qualification parameter values; this column was logically off the screen to the right of the first Breakpoints panel. To resume the format of the Breakpoints panel, use the RESUME primary command or select the Breakpoints choice from the Qualify pull-down.

Dialog Test

Menu Qualify Utilities Help

Breakpoints Row 1 to 5 of 13

Add, delete, and change breakpoints. Underscores need not be blanked.
Enter END command to finalize changes.

Service (Required)	When (BEFORE,AFTER,Rnn) (No entry=all)	Qualification parameter values (No entry=none) ("AND" is assumed between values)
_____	_____	_____
_____	_____	_____
_____	_____	_____
_____	_____	_____
_____	_____	_____

Command ==> Scroll ==> PAGE

F1=Help	F2=Split	F3=Exit	F4=Expand	F5=Rfind
F6=Resize	F7=Backward	F8=Forward	F9=Swap	F10=Actions

F1=Help F2=Split F3=Exit F7=Backward F8=Forward F9=Swap
F10=Actions F12=Cancel

Figure 235. Breakpoints panel with qualification parameter values (ISPYBP2)

The lines on the Breakpoints panel with qualification parameter values correspond to the lines on the first Breakpoints panel; "Specifying breakpoints" on page 414 describes the Service and When fields. In the Qualification parameter values field, for all services except SELECT, you can enter any combination of:

- One or more parameter values, separated by blanks, that the dialog passes to the service. No order is implied by the specification of the parameter values.
For example, if you want a breakpoint to occur when message ABC0001 is included on a DISPLAY service request, specify ABC0001. If the breakpoint should occur only when message ABC0001 and panel XYZ are both included, specify ABC0001 XYZ.
- One or more command call keywords, separated by blanks, that have values that are not blank when a dialog calls the service. For ISPLINK or ISPLNK calls, the keywords matching the calling sequence parameter positions are used.
For example, if you want a breakpoint to occur whenever the DISPLAY service is called with a message, then specify MSG.

For ISPF's SELECT and ISREDIT services, you can enter one or more parameter strings that would be entered on these two service calls. A *parameter string* is a series of characters delimited by a blank, a comma, a single quotation mark, or a left or right parenthesis.

For example, if a SELECT call is:

```
SELECT PGM(ABC) PARM(1 2 3 5 '6'),
```

then all or any of these strings can be used: SELECT, PGM, ABC, 1, 2, 3, 5, 6.

For a breakpoint to be taken, all qualification data listed must be matched.

All line commands and change capabilities are still available on the Breakpoints panel with qualification parameter values.

During dialog processing, to determine whether the criteria for a breakpoint have been met, Dialog Test processes a logical AND of the Service, When, Function, Active, and Qualification fields specified for that breakpoint. Therefore, if you want more than one breakpoint for an ISPF service, you should create multiple rows.

When you use the Breakpoints option (7.8), be aware of these items:

Qualification

If you plan to qualify several breakpoints, it can be more efficient to specify all breakpoint data on the Breakpoints panel with qualification parameter values.

END command

You can use the END primary command from either the first Breakpoints panel or the Breakpoints panel with qualification parameter values.

Input errors

You must correct input errors before leaving any display using the END, QUAL, or RESUME command. You can use the CANCEL command to end the Breakpoints option, even if input errors remain on the display.

Syntax checking

A dialog service call must pass a basic syntax check before a breakpoint is honored.

Control display

If any CONTROL service settings for DISPLAY LINE or DISPLAY SM (Session Manager) were in effect before the breakpoint, such settings are lost.

Finding a breakpoint

If you call a dialog function or selection panel and find a breakpoint, the Breakpoint Primary Option Panel is displayed. Figure 236 on page 418 shows this selection panel at a breakpoint just after the ISPF DISPLAY service was called while processing the TEST function in application PAY.

Breakpoints (option 7.8)

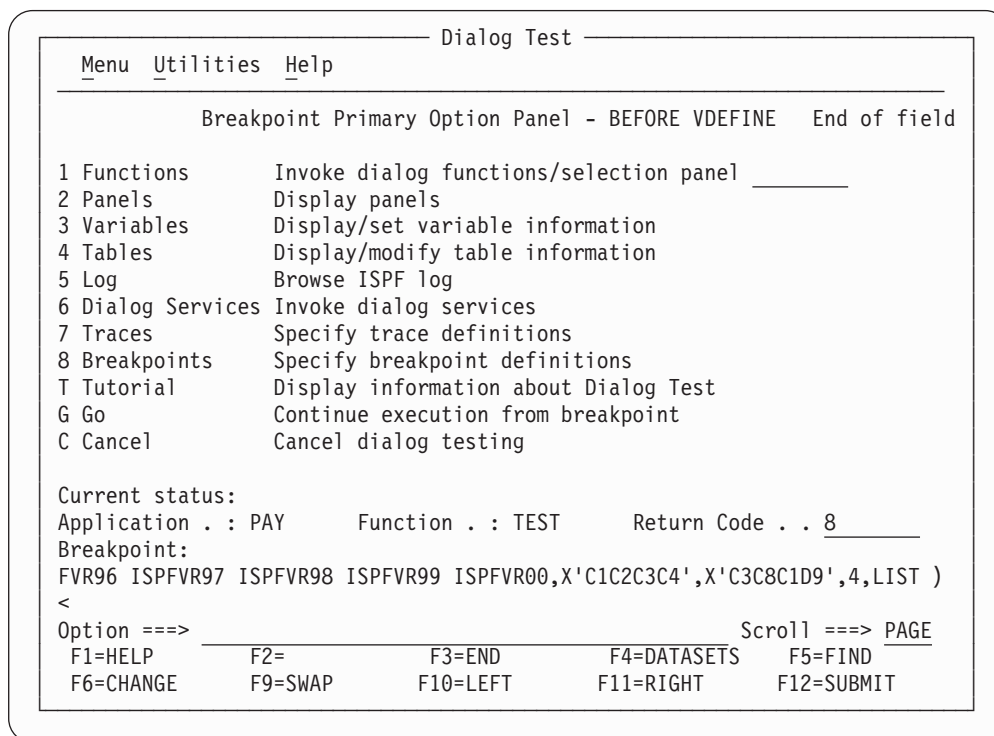

Figure 236. Breakpoint Primary Option panel (ISPYXM1)

Like the Dialog Test Primary Option Panel, the Breakpoint Primary Option Panel allows you to use the RETURN command from any one of the selected test options to display the Breakpoint Primary Option Panel again. At the Breakpoint Primary Option Panel, the END and RETURN commands have no effect. You must use the Go option (G) to end processing at this breakpoint and continue processing the dialog being tested, or the Cancel option (C) to cancel the Dialog Test option (7). This protects against inadvertent loss of data.

The Breakpoint Primary Option Panel contains all the options of the Dialog Test Primary Option Panel except Exit (7.x) and, as such, presents all but one of the Dialog Test functions to you.

This panel also contains two options not shown on the Dialog Test Primary Option Panel: Go (G) and Cancel (C). When a breakpoint occurs, these options allow you to continue processing or stop processing, respectively:

- G** The Go option continues dialog processing from a breakpoint. The user dialog resumes processing from the point at which it was suspended.
- C** The Cancel option ends dialog testing and displays the first primary option panel you displayed at the beginning of your ISPF session again. All trace and breakpoint definitions are lost when you leave Dialog Test.

When a user dialog finds a breakpoint, the current dialog environment is saved. When you select the Go option, the environment is restored, except that:

- If you change variable, table, and file tailoring data at a breakpoint, these actions are an extension of the suspended dialog; it is as though the dialog had taken all the actions itself during processing.
- If you change the service return code on the Breakpoint Primary Option Panel, the new return code is passed back to the dialog as though the service had set the new return code itself.

- If you process the PANELID command at the breakpoint, the last setting for displaying panel identifiers is retained.
- If any CONTROL service settings for DISPLAY LINE or DISPLAY SM (Session Manager) were in effect before the breakpoint, such settings are lost.

Note that the manipulation of one dialog part can cause a change to another dialog part. For example, if a panel is displayed, variables can be set.

All trace and breakpoint definitions are lost if you select the Cancel option.

The Breakpoint Primary Option Panel also displays this information:

AFTER or BEFORE

An indication of whether the dialog has been suspended after or before the service has processed.

Service Name

The name of the service at which the dialog has been suspended. In Figure 236 on page 418, the service name is DISPLAY.

Current status:

The application's current status when the breakpoint occurred. These fields show this status:

Application

The application identifier of the suspended user dialog.

Function

The program or command name of the suspended user dialog.

Return code

The dialog service return code. This field is displayed only if the breakpoint occurs after the dialog service has processed. The Return code field is modifiable; its value is passed back to the dialog (as the service's) when you select the Go option. This helps test dialog error handling.

Breakpoint

One scrollable line showing an image of the dialog service call. Place the cursor over the image and use LEFT, RIGHT, and EXPAND functions to scroll the area. < and > appear below the line to indicate in which direction more data may be available. A maximum of 2048 characters may be displayed.

ISPEXEC calls are shown as typed.

ISPLINK (ISPLNK) calls are displayed with their parameter values separated by commas. Name-lists are shown as typed in the dialog, in string format or in structure format. Structure format includes the count, element length, and list of names. For variable services parameters whose context is defined by the name-list parameter on the service call (for example, the variable value areas for a VDEFINE), the first four bytes of the parameter value are displayed in hexadecimal format (X'nnnnnnnn').

ISPEXEC calls from a program are the same as ISPEXEC calls from a command except that ISPEXEC is not displayed.

Tutorial (option 7.T)

Tutorial (option 7.T)

The Tutorial option (7.T) allows you to display information about the Dialog Test facilities. Figure 237 shows the first panel displayed when you select the Tutorial option.

```
Tutorial ----- Dialog Test Tutorial ----- Tutorial
                                     |
                                     | ISPF Dialog Test |
                                     |
This tutorial provides information about the features and operation of Dialog
Test.

The Dialog Test tutorial consists of two parts: one describes the Dialog Test
option, as selected from the ISPF Primary Option Panel, and the other
describes the Dialog Test facilities available when a user dialog encounters a
"breakpoint" in its processing.

Beginning users should review the Dialog Test Option topic first.

The following topics are presented in sequence, or can be selected by number:

    1 - Dialog Test Option
    2 - At A User Dialog Breakpoint
----- Cur panel = ISP70000 Prev panel = ISPYXD1 Last msg = ISYP014 -----
Option ==>
F1=Help      F2=Split    F3=Exit      F4=Resize   F5=Exhelp   F6=Keyshelp
F7=PrvTopic  F8=NxtTopic  F9=Swap      F10=PrvPage F11=NxtPage F12=Cancel
```

Figure 237. Dialog Test Tutorial - first panel (ISP70000)

The default function key command assignments for a terminal with 12 function keys are shown at the bottom of the screen if you enter the PFSHOW command.

Exit (option 7.X)

The Exit option (7.X) ends your Dialog Test session. All trace and breakpoint definitions are lost.

Chapter 10. IBM products (option 9)

Option 9 provides an interface to other IBM program development products. It displays a panel that lists other IBM products that are supported as ISPF dialogs, as shown in Figure 238.

```
Menu Utilities Compilers Options Status Help

Additional IBM Program Development Products
Option ==> _____

3 INFOMAN Tivoli Information Management for z/OS
4 COBOL/SF COBOL Structuring Facility
6 SDF II Screen Definition Facility II - Editors and Utilities
7 SDF II-P Screen Definition Facility II - Prototype

F1=Help F2=Split F3=Exit F7=Backward F8=Forward
F9=Swap F10=Actions F12=Cancel

Enter X to Terminate using Log/List defaults

F1=Help F2=Split F3=Exit F7=Backward F8=Forward F9=Swap
F10=Actions F12=Cancel
```

Figure 238. Additional IBM Program Development Products Panel (ISRDIIS)

When you select one of these products, ISPF tries to call it. However, the only way ISPF can determine whether a product is installed and available is to check for the existence of a single product-related panel in the panel library concatenation. No other check is made to ensure that the product is correctly installed or that it is completely available to you.

If the product is not installed or is unavailable, ISPF displays an informational panel that describes the product and shows how to obtain more information.

The names of the products on this panel are point-and-shoot fields. For more information on point-and-shoot fields, see the ISPF User Interface topic in the *z/OS ISPF User's Guide Vol I*.

Chapter 11. SCLM (option 10)

Option 10 gives you access to the Software Configuration and Library Manager (SCLM), which is an extension of the ISPF library concept. You call SCLM functions by entering one of the options shown on the panel in Figure 239.

If SCLM does not appear on any of your menu panels or on the Menu pull-down, enter TSO SCLM on any ISPF command line. If SCLM is available to your terminal session, the SCLM Main Menu is displayed.

For more information about SCLM, refer to *z/OS ISPF Software Configuration and Library Manager Guide and Reference*.

<u>M</u> enu	<u>U</u> tilities	<u>H</u> elp
SCLM Main Menu		Enter option
Enter one of the following options:		
1	View	ISPF View or Browse data
2	Edit	Create or change source data in SCLM databases
3	Utilities	Perform SCLM database utility/reporting functions
4	Build	Construct SCLM-controlled components
5	Promote	Move components into SCLM hierarchy
6	Command	Enter TSO or SCLM commands
6A	Easy Cmds	Easy SCLM commands via prompts
7	Sample	Create or delete sample SCLM project
A	SCLM Admin	Maintaining SCLM administrators
X	Exit	Terminate SCLM
SCLM Project Control Information:		
Project	_____	(Project high-level qualifier)
Alternate	_____	(Project definition: defaults to project)
Group	_____	(Defaults to TSO prefix)
Option ==>>		
F1=Help	F2=Split	F3=Exit
F10=Actions	F12=Cancel	F7=Backward F8=Forward F9=Swap

Figure 239. SCLM Main Menu (FLMDMN)

The option names on this panel are point-and-shoot fields. See the Point-and-Shoot Text Fields section of the ISPF User Interface topic in the *z/OS ISPF User's Guide Vol I* for more information.

SCLM Main Menu action bar

The SCLM Main Menu panel action bar choices function as follows:

Menu For more information, see the details about the Menu Action Bar Choice in the ISPF User Interface topic in the *z/OS ISPF User's Guide Vol I*.

Utilities

For more information, see details about the Utilities Action Bar Choice in the ISPF User Interface topic in the *z/OS ISPF User's Guide Vol I*.

Help

The Help pull-down provides general information about SCLM topics as well as information about each available choice on the SCLM Main Menu.

SCLM overview

SCLM is a library facility that supports projects in developing complex software applications. It does this by providing software configuration and library management support. SCLM supports the software development cycle of an application from the program design phase to release of the final product.

SCLM allows designers and programmers to define the architecture of an application (how the components fit together) and ensures that the architecture definition is followed by automatically controlling, maintaining, and tracking software components. By automatically enforcing guidelines and procedures for developing software, SCLM enhances software quality and improves programmer productivity. For complete information on using SCLM, refer to *z/OS ISPF Software Configuration and Library Manager Guide and Reference*.

SCLM addresses these software configuration and library management issues:

- Ensures that two programmers are not working on the same component at the same time.
- Allows users to integrate components only at the correct time and only by using the correct procedure.
- Logs and tracks software changes.
- Provides application integrity; all of the software components used to produce the final product are available, but controlled.
- Documents the interfaces between the software components.

SCLM provides these facilities for automating software configuration and library management tasks:

Project Definition

Establishes the database.

Edit Uses the ISPF editor to create and modify the software components.

Build Integrates the software components.

Promote

Moves software components through the library hierarchy.

Utilities

Maintain the database.

Reports

Generate information about the build and promote activities, and about the contents of the database.

Interactive dialogs, batch interfaces, and callable services provide access to the functions and capabilities of SCLM. These functions support the routine use of SCLM by:

- Allowing programmers to use the ISPF editor to create and modify software components
- Providing automated draw down and lockout functions without requiring special customizing to suit a particular installation.

Chapter 12. ISPF object/action workplace (option 11)

Option 11 gives you access to the ISPF Object/Action Workplace. The Workplace combines many of the ISPF functions onto one object-action interface. The idea of object-action is to specify an *object* (such as an ISPF library, data set name, or workstation file) and then specify an *action* to perform upon it. You can specify any of these objects:

- An ISPF Library—a cataloged partitioned data set (PDS) with a three-level data set name in the project.group.type format.
- A partitioned or sequential data set.
- A VSAM data set for use with the data set actions allocate, delete, or information.
- A DSLIST level for data set list actions, for example, 'YOURID.*' for all data sets beginning with YOURID.
- A workstation file name for use with the actions edit or view.
- A volume serial number for uncataloged data sets to use with actions to retrieve volume information, print volume information, build a DSLIST based on a volume serial number, or as a filter for a DSLIST level.
- Personal data set lists or reference lists for use with action DL (DSLIST) only.

Additionally, Workplace provides ISPF Referral list fields to enable object selection through retrieval from personal lists (pre-packaged lists of data sets which you create) or reference lists (lists of recently referenced data sets which ISPF creates).

You can select an action by making a choice on an action bar or by using a command. Eighty-five ISPF functions are available as workplace actions.

There is a fast path system command for starting the Workplace. Type ISPFWORK on any ISPF command line and you are taken to the Workplace entry panel.

You can display the Workplace in GUI mode as well as standard mode. See “Workstation connection” on page 61 for information about how to start GUI mode for ISPF. All of the screens that appear in associated topics are shown in their standard mode.

Selecting objects

The first step in using the Workplace to perform ISPF functions is to specify the particular object that you want to perform an action on, for example, a sequential data set 'YOURID.SOURCE.DATA'. Object specification takes place on the Workplace entry panel.

Workplace entry panel

When you first enter the Workplace, the entry panel that appears is called ISPF Workplace. It is possible to display this panel in two distinct modes, called views: the *Library View* or the *Data Set View*.

The Library View panel has the words “Library View” as a heading just above the referral lists in the lower portion of the screen. This view enables you to work with ISPF library concatenations and library lists.

The Data Set View panel has the words “Data Set View” as a heading just above the referral lists in the lower portion of the screen. This view enables you to work

Workplace (Option 11)

with data set lists, sequential files, or single partitioned data sets. You can choose to work with either entry panel view by using the command LISTVIEW, or the function key ChgView (F11) to toggle between the two panels.

Library view

You use the Library View to work with a ISPF library concatenations. The panel that appears in Figure 240 is the Library View entry panel for the Workplace.

```
File View Options Space SuperC Test Help
-----
Smart Action      ISPF Workplace

ISPF Library
Project . . . _____
Group . . . . . _____ . . . _____ . . . _____
Type . . . . . SOURCE
Member . . . . . _____ (Blank or pattern for member action list)

----- ISPF Referral lists for object selection -----
Library View Action #1-8=Retrieve Entry DL=DSLST /=Open List
MYLIST . . . _____ MANUAL DUMMY DATA 02/07/08 11:36
REFLIST . . . _____ Last 8 referenced libraries -----
***** End of ISPF Referral lists *****

Action ==> _____ Scroll ==> PAGE
F1=Help F2=Split F3=Exit F4=Settings F5=PrvObj F6=PrvAct
F7=Backward F8=Forward F9=Swap F10=Actions F11=ChgView F12=Cancel
```

Figure 240. Workplace entry panel - library view (ISRWORK1)

When using this Workplace entry panel, you can select a data set or a group of data sets to work with in one of these ways:

- Fill in the ISPF Library fields. These fields are used the same way as they are on other ISPF panels. You can use the traditional method of selecting a data set by entering its Project, Group, Type, and Member names in the ISPF Library fields. Omitting the Member name gives you a list of members to choose from.
- Select an object or list of objects using “ISPF Referral lists for object retrieval”. See “ISPF referral lists for object retrieval” on page 427 for more information. You can access personal and reference lists, and then select libraries from these lists.

Data set view

You use the Data Set View to work with a single data set, a list of data sets, a workstation file, or any action that requires a volume serial.

Note: Catalog, DSLIST, Volume information, Print volume, and Workstation file actions, are only available from the Data Set View.

The panel that appears in Figure 241 on page 427 is the Data Set View entry panel for the Workplace.

```

File View Options Space SuperC Test Help
-----
Smart Action      ISPF Workplace
Data Set, DSLIST Level, or Workstation File
Object Name . . . 'MYPROJ.DEV.SOURCE'
Volume Serial . . _____ (For actions that require a volume serial)

ISPF Referral lists for object selection
-----
Data Set View Action #1-30=Retrieve Entry DL=DSLIST /=Open List
REFLIST . . . _____ Last 30 referenced data sets -----
TEST . . . _____ Test list 02/10/01 12:06
TEST2 . . . _____ Second Test List 02/10/01 12:05
***** End of ISPF Referral lists *****

Action ==> _____ Scroll ==> PAGE
F1=Help F2=Split F3=Exit F4=Settings F5=PrvObj F6=PrvAct
F7=Backward F8=Forward F9=Swap F10=Actions F11=ChgView F12=Cancel

```

Figure 241. Workplace entry panel - data set view (ISRWORK)

When using this Workplace entry panel, you can select a data set or a group of data sets to work with in one of these ways:

- You can use the traditional method of selecting a data set by entering its name in the Object Name field. For example, enter 'YOURID.SOURCE.DATA' to act upon a data set on the host, or D:\YOUR.FIL to act upon a workstation file (perhaps to edit it using the PDF editor).

Note: The Object Name field supports the inclusion of system symbols.

- Select an object or list of objects using “ISPF Referral lists for object retrieval”. You can access personal and reference lists, and select data sets, libraries, workstation files, VSAM files, and data set levels from each list.

ISPF referral lists for object retrieval

Both views of the ISPF Workplace entry panel enable you to use referral lists. The bottom of the ISPF Workplace panel contains a reference list entry field (REFLIST), followed by a list of personal lists. You can display either referral library lists or referral data set lists, depending on the view you choose.

All data sets and libraries referenced during an ISPF session are appended to the reference lists. You can use the input fields next to the referral lists to access a referral data set in one of these ways:

- Entering a slash (/) in this field causes the personal data set list or library list (depending on the selected view) to be displayed.
- Type DL in the input field and press Enter. This builds a DSLIST based on entries in the personal data set list, personal library lists, or Reflists.
- Enter a library entry number (from 1 to 8). If you know the list numbers of your libraries, for example, your panels library is number 1, you can type the number in this field and press Enter. ISPF retrieves the respective library entry from the library reference list.
- Enter a data set entry number (from 1 to 30). If you know the order of your data sets, you can type the number in this field and press Enter. ISPF retrieves the respective data set entry from the data set reference list.

Specifying actions

After you select the object you want to work with, choose the action to perform on it. You can select an action by making a choice on an action bar or by using a command.

Choices on the Workplace action bar

The Workplace action bar makes available these choices.

File

The File action bar choice enables you to manipulate files. The pull-down choices for File are:

Choice Description

List Displays a pop-up menu that enables you to choose either a *member list*, a *data set list*, a list of *personal data set lists* or a list of *personal library lists*. You can perform any of the File actions except *DSL* against the resulting member list.

Member list

Displays a list of members for a partitioned data set. To display a member list:

1. Type the library or data set information in the appropriate fields of the Workplace entry panel (library view).
2. Specify blank or a pattern for the member name to display a member list.
3. Select the List action from the File action bar choice.
4. Select "Member list" from the List Action prompt panel.

Note: All member lists displayed by the ISPF Workplace are enhanced member lists, all supported member list actions and commands are available on any member list display.

Data Set list

Displays a list of data sets based on a *DSL* level and, optionally, a volume serial number. The data set list initial view can be set from the Workplace Settings panel. To create a data set list:

1. Type the data set level in the Object name field on the Workplace entry panel (data set view). If you do not fully qualify the data set level (by enclosing it in single quotes), your TSO prefix is set as the first level. Optionally, you can enter a volume to view just the data sets that match the *DSL* level on the volume entered. You can also optionally enter just a volume name to list all data sets on the volume entered.
2. Select the List action from the File action bar choice.
3. Select Data Set List from the List Action prompt panel.

Personal Data Set lists

Displays a list of your personal data set lists. All valid personal list actions can be performed against any selected personal list. The personal data set list you used most recently is the current active list. The currently active list cannot be directly deleted from the list dialog, however all other list actions are valid. To list your personal data set lists:

1. Select the List action from the File action bar choice.

2. Select Personal Data Set List from the List Action prompt panel. You can perform this action from either view of the Workplace entry panel.

Personal Library lists

Displays a list of your personal library lists. All valid personal list actions can be performed against any selected personal list. The personal library list you used most recently is the current active list. The currently active list cannot be directly deleted from the list dialog, however all other list actions are valid. To list your personal library lists:

1. Select the List action from the File action bar choice.
2. Select Personal Library List from the List Action prompt panel. You can perform this action from either view of the Workplace entry panel.

Edit Starts Edit action for a member or a sequential file. The Edit action prompt panel is presented when you choose the Edit pull-down choice on the action bar. Select a file type and an editor and press Enter. The Edit function is used to edit a member of a partitioned data set, a sequential data set, or a workstation file.

Type of File

Select the type of file you want to edit.

1. Host File

Edit a host file using ISPF Edit or a workstation-defined editor. The selection of host or workstation editors is based on the Editor Choice option setting on the Edit Entry panel. To start the member list function, enter a pattern or leave the member field blank on the Workplace entry panel. To edit a single member on the host:

1. Type the library or data set information in the appropriate fields of the Workplace entry panel.
2. Type the member name in the member field (for library view) or in parentheses after the data set name (for data set view).
3. Select Edit under the File action bar choice.
4. Select Host File and ISPF Editor on the Edit Action prompt panel.

To edit a single member on the workstation:

1. Type the library or data set information in the appropriate fields of the Workplace entry panel.
2. Type the member name in the member field (for library view) or in parentheses after the data set name (for data set view).
3. Select Edit under the File action bar choice.
4. Select Host File and Workstation Editor on the Edit Action prompt panel.

2. Workstation File

To edit a workstation file using the ISPF editor:

1. Type the file path and name in the Object name field on the Workstation entry panel (data set view).
2. Select Edit from the File action bar choice.
3. Select Workstation File and ISPF Editor from the Edit Action prompt panel.

Workplace (Option 11)

To edit a workstation file using a workstation editor:

1. Type the file path and name in the Object name field on the Workstation entry panel (data set view).
2. Select Edit from the File action bar choice.
3. Select Workstation File and Workstation Editor from the Edit Action prompt panel.

Editor Choice

1. ISPF Editor

Selects the ISPF editor.

2. Workstation Editor

Selects the workstation editor.

View Starts View action for a member or a sequential file. The View prompt panel is presented when you choose the View pull-down choice on the File action bar. The View function is used to view a member of a partitioned data set, a sequential data set, or a workstation file.

Type of File

Select the type of file you want to view.

1. Host File

View a host file using ISPF View or a workstation-defined editor/browser. The view mechanism used is based on the *View Choice* setting found on the View entry panel. To enter the member list function, type a pattern or leave the member field blank on the Workstation entry panel. To view a single member on the host:

1. Type the library or data set information in the appropriate fields on the Workplace entry panel.
2. Type the member name in the member field (for ISPF library view) or in parentheses after the data set name (for data set view).
3. Select View from the File action bar choice.
4. Select Host File and ISPF View from the View Action prompt panel.

To view a single member on the workstation:

1. Type the library or data set information in the appropriate fields on the Workplace entry panel.
2. Type the member name in the member field (for ISPF library view) or in parentheses after the data set name (for data set view).
3. Select View from the File action bar choice.
4. Select Host File and Workstation View from the View Action prompt panel.

2. Workstation File

To view a workstation file using ISPF View:

1. Type the file path and name in the Object name field of the Workstation entry panel (data set view).
2. Select View from the File action bar choice.
3. Select Workstation File and ISPF View from the View Action prompt panel.

To view a workstation file using a workstation editor or browser:

1. Type the file path and name in the Object name field of the Workstation entry panel (data set view).
2. Select View from the File action bar choice.
3. Select Workstation File and Workstation View from the View Action prompt panel.

View Choice

1. ISPF View

Selects the ISPF view function.

2. Workstation View

Selects the workstation editor or browser.

Browse

Starts Browse action for a member or a sequential file.

If you do not specify a member name or if you specify a pattern and the specified data set is a PDS, a member list is displayed. Select a member to Browse by typing *s* next to the member name.

To browse a single member:

1. Type the library or data set information in the appropriate fields of the ISPF Workplace panel.
2. Type the member name in the member field (for ISPF library view) or in parentheses after the data set name (for data set view).
3. Select Browse from the File action bar choice.

Delete Displays a pop-up prompt window with *member* or *data set* as the choices.

If you specify an asterisk (*) as the member name, all members of the PDS are deleted without a member list being displayed.

If you do not specify a member name or if you specify a pattern and the specified data set is a PDS, a member list is displayed. Select members to delete by typing *s* next to the member name.

Note: You can change how member name patterns are handled in your Workplace Settings. See Show status for M,C,D,G actions for more information.

To delete a single member:

1. Type the library or data set information in the appropriate fields of the ISPF Workplace panel.
2. Type the member name in the member field (for ISPF library view) or in parentheses after the data set name (for data set view).
3. Select Delete under the File action bar choice for member delete.

To delete a PDS or a sequential data set:

1. Enter the data set name in the Object name field, or enter a library in the ISPF Library field on the Workplace panel.
2. Select Delete under the File action bar choice for data set delete.

Rename

Displays a pop-up prompt window with *member* or *data set* as the choices.

If you do not specify a member name or if you specify a pattern and the specified data set is a PDS, a member list is displayed. Select a member to Rename by typing *s* next to the member name.

To rename a single member:

1. Type the library or data set information in the appropriate fields of the ISPF Workplace panel.

Workplace (Option 11)

2. Type the member name in the member field (for ISPF library view) or in parentheses after the data set name (for data set view).
3. Select Rename under the File action bar choice for member rename.

To rename a PDS or a sequential data set:

1. Type the data set name in the Object name field, or type a library in the ISPF Library field on the Workplace panel.
2. Select Rename under the File action bar choice for data set rename.

For more information, see "Rename" on page 445.

Move Starts the move action for a member or a sequential file. A Move entry panel is presented.

If you specify an asterisk (*) as the member name, all members of the PDS are moved without a member list being displayed.

If you do not specify a member name or if you specify a pattern and the specified data set is a PDS, a member list is displayed. Select members to move by typing s next to the member name.

Note: You can change how member name patterns are handled in your Workplace Settings. See Show status for M,C,D,G actions for more information.

To move a single member:

1. Type the library or data set information in the appropriate fields of the ISPF Workplace panel.
2. Type the member name in the member field (for ISPF library view) or in parentheses after the data set name (for data set view).
3. Select Move from the File action bar choice.

For more information, see "Move or copy" on page 444.

Copy Starts the copy action for a member or a sequential file. A Copy entry panel is presented.

If you specify an asterisk (*) as the member name, all members of the PDS are copied without a member list being displayed.

If you do not specify a member name or if you specify a pattern and the specified data set is a PDS, a member list is displayed. Select members to copy by typing s next to the member name.

Note: You can change how member name patterns are handled in your Workplace Settings. See Show status for M,C,D,G actions for more information.

To copy a single member:

1. Type the library or data set information in the appropriate fields of the ISPF Workplace panel.
2. Type the member name in the member field (for ISPF library view) or in parentheses after the data set name (for data set view).
3. Select Copy from the File action bar choice.

For more information, see "Move or copy" on page 444.

Reset Starts reset action for a member. A Reset prompt panel is presented for the member.

If you specify an asterisk (*) as the member name, all members of the PDS are reset without a member list being displayed.

If you do not specify a member name or if you specify a pattern and the specified data set is a PDS, a member list is displayed. Select members to reset by typing `s` next to the member name.

Note: You can change how member name patterns are handled in your Workplace Settings. See Show status for M,C,D,G actions for more information.

To reset a single member:

1. Type the library or data set information in the appropriate fields of the ISPF Workplace panel.
2. Type the member name in the member field (for ISPF library view) or in parentheses after the data set name (for data set view).
3. Select Reset from the File action bar choice.

For more information, see “Resetting member statistics” on page 440.

Open Is defined on the Workplace Settings panel, making it a user customizable action. After you set this action, it is performed automatically each time you open a member. The Open action can be set to these actions:

User Any TSO command, REXX exec, or CLIST set by the **Open Command** field on the Workplace Settings panel.

E	Edit
V	View
B	Browse
D	Delete member
R	Rename member
M	Move
C	Copy
G	Reset
P	Print member
J	Submit
T	TSO command action

To open a single member:

1. Type the member name in the member field (for ISPF library view) or in parentheses after the data set name (for data set view).
2. Select Open from the File action bar choice. When you press the ENTER key, the action for open runs against the member, or a member list is displayed. See “Changing workplace settings” on page 449 for more information.

Submit

Submits the member or sequential file to TSO for job execution.

If you do not specify a member name or if you specify a pattern and the specified data set is a PDS, a member list is displayed. Select a member to submit by typing `s` next to the member name.

To submit a single member, fill in these fields of the ISPF Workplace panel:

1. Type the library or data set information in the appropriate fields.
2. Type the member name in the member field (for ISPF library view) or in parentheses after data set name (for data set view).
3. Select Submit from the File action bar choice.

Print The Print selection enables you to print information. The pull-down choices on the Print action prompt panel are:

Data Set

Prints the entire data set. To print a data set:

Workplace (Option 11)

1. Type the data set name in the Object name field (for the data set view) or enter an ISPF library name in the ISPF Library fields (for the library view).
2. Select the Print action from the File action bar choice.
3. Select Data Set from the Print Action prompt panel.

Data Set index

Prints the data set index for the selected data set. To print a data set index:

1. Type the data set name in the Object name field or type an ISPF library name in the ISPF Library fields.
2. Select the Print action from the File action bar choice.
3. Select Data Set Index from the Print Action prompt panel.

Data Set List

Prints the list of data sets for the selected data set name level. To print a data set list:

1. Type a data set level, or optionally a volume serial, in the appropriate fields on the ISPF Workplace panel.
2. Select Print from the File action bar choice.
3. Select Data set List from the Print Action prompt panel.

VTOC Prints the VTOC information for the selected volume. To print a VTOC summary:

1. Type a volume serial in the proper field on the ISPF Workplace panel.
2. Select Print from the File action bar choice.
3. Select VTOC from the Print Action prompt panel.

Member

Prints the selected member. To print a member:

1. Type the data set name in the Object name field or type an ISPF library name in the ISPF Library fields.
2. Select the Print action from the File action bar choice.
3. Select Member from the Print Action prompt panel.

Command

Enables you to enter TSO, Workstation, or ISPF commands. You are prompted to choose between types of commands. The pull-down choices on the Command prompt are:

TSO Cmd

The TSO Cmd action is used to run a TSO command, passing the data set and member name and any additional parameters to the TSO command entered. To run a TSO command against a single member, fill in these fields of the ISPF Workplace panel:

1. Type the library or data set information in the appropriate fields.
2. Type the member name in the member field (for ISPF library view) or in parentheses after the data set name (for data set view).
3. Select Command from the File action bar choice.
4. Select TSO from the Command Action prompt panel.

WS Cmd

The WS Cmd action is used to run a WS command, passing the data set and member name and any additional parameters to the WS command entered.

To run a WS command against a single member, fill in these fields of the ISPF Workplace panel:

1. Type the library or data set information in the appropriate fields.
2. Type the member name in the member field (for ISPF library view) or in parentheses after the data set name (for data set view).
3. Select Command from the File action bar choice.
4. Select WS command from the Command Action prompt panel.

Note: The ISPF Client/Server must be connected to run the WS command.

ISPF Command Shell

The ISPF command shell option enables TSO commands, CLISTs, and REXX execs to be run under ISPF. You can enter the TSO commands, CLISTs, and REXX execs in the command input field of any panel.

ISPF also enables Workstation commands to be entered in the command input field of any panel.

You can enter a long command that wraps to the next line if you want to. For more information about the ISPF Command Shell, see "ISPF command shell" on page 442.

ISPF Command Table

The command table utility allows you to create or change application command tables.

A command table contains the specification of general commands that can be entered from any panel during the execution of an application. Command tables are identified by application id, and are maintained in the ISPF table input library.

Exit Ends the Workplace, returning to the primary option panel.

View

The View action bar choice displays the object views that are available to you. The currently selected view is unavailable.

The pull-down choices for View are:

Choice Description

Data Set View

Changes the current view to reference data set list, personal data set lists, and Object name view.

To change to the data set view:

1. Select the View action bar choice.
2. Select Data Set View from the pull-down menu.

Library View

Changes the current view to reference library list, personal library lists, and ISPF Library view.

To change to the ISPF Library view:

1. Select the View action bar choice.
2. Select Library View from the pull-down menu.

Workplace (Option 11)

By name

Changes the current view of the personal list by sorting on the name field.

By description

Changes the current view of the personal list by sorting on the description field.

By created

Changes the current view of the personal list by sorting on the created field.

By referenced

Changes the current view of the personal list by sorting on the referenced field.

Options

The Options action bar choice displays the settings available. The pull-down choices for Options are:

Choice Description

Workplace Settings

Displays the Workplace Settings panel. See “Changing workplace settings” on page 449 for more information.

ISPF Settings

Displays the ISPF Settings panel. See Chapter 2, “Settings (option 0),” on page 23 for more information.

CUA Attributes

Starts the ISPF CUA Attribute Change Utility dialog. See “CUA attributes” on page 55 for more information.

Keylists

Starts the ISPF Keylist Utility dialog. See “Working with function keys and keylists (the Function Keys action bar choice)” on page 37 for more information.

Point-and-Shoot

Starts the ISPF CUA Attribute Change Utility dialog indexed to the point-and-shoot entry. See “CUA attributes” on page 55 for more information.

Colors Starts the ISPF Global Color Change Utility dialog. See “Changing default colors (the Colors action bar choice)” on page 51 for more information.

Space

The Space action bar choice enables you to create and maintain data sets. The pull-down choices available for Space are:

Choice Description

Allocate

Displays a pop-up menu for the allocate action. The choices on the prompt are:

Data Set

The allocate action is used to allocate a partitioned or sequential data set. To allocate a data set:

1. Type the data set name in the Object name field or type an ISPF library name in the ISPF Library fields.
2. Select the Allocate action from the Space action bar choice.
3. Select Data Set from the Allocate Action prompt panel.

Enhanced Data Set

The enhanced allocate action is used to allocate an SMS-managed partitioned or sequential data set. To allocate an SMS data set:

1. Type the data set name in the Object name field or enter an ISPF library name in the ISPF Library fields.
2. Select the Allocate action from the Space action bar choice.
3. Select Enhanced Data Set from the Allocate Action prompt panel.

VSAM Data Set

The VSAM action is used to define, delete, or retrieve information for a VSAM data set. To define, delete, or retrieve information for a VSAM data set:

1. Type the VSAM data set name in the Object name field or enter an ISPF library name in the ISPF Library fields.
2. Select the Allocate action from the Space action bar choice.
3. Select VSAM Data Set from the Allocate Action prompt panel.

Compress

The Compress action is used to recover unused space in a partitioned or sequential data set. To compress a data set:

1. Type the data set name in the Object name field or type an ISPF library name in the ISPF Library fields.
2. Select the Compress action from the Space action bar choice.

Catalog

The Catalog action is used to catalog a partitioned or sequential data set on a direct access device. To catalog a data set:

1. Type the data set name in the Object name field.
2. Type the volume name in the volume field.
3. Select the Catalog action from the Space action bar choice.

Note: You cannot catalog an SMS-managed data set.

Uncatalog

The Uncatalog action is used to uncatalog a partitioned or sequential data set from a direct access device. To uncatalog a data set:

1. Type the data set name in the Object name field.
2. Select the Uncatalog action from the Space action bar choice.

Note: You cannot uncatalog an SMS-managed data set.

A confirmation dialog appears if specified in the Workplace Settings panel. See “Changing workplace settings” on page 449 for more information.

Information

The Data Set Information action is used to retrieve information about a partitioned or sequential data set. To retrieve data set information:

1. Type the data set name in the Object name field or type an ISPF library name in the ISPF Library fields.
2. Select Information from the Space action bar choice.
3. Select one of these choices from the Information Action prompt panel:

Data Set Long

Displays information about the selected data set.

Data Set Short

Displays a subset of information about the selected data set.

VTOC summary

Displays VTOC information about the selected volume. You

Workplace (Option 11)

must type the volume serial of the VTOC in the volume serial field of the Workplace entry panel.

SuperC

The SuperC action bar choice gives you access to SuperC compare and search dialogs for your data sets. The data set you specify on the Workplace panel is automatically filled in for you in the SuperC dialog you choose. For more information, see “SuperC utility (option 3.12)” on page 207.

The SuperC pull-down choices are:

Choice Description

SuperC

Compare two data sets. To SuperC compare two data sets:

1. Type the first data set name in the Object name field or type an ISPF library name in the ISPF Library fields.
2. Select the SuperC action from the SuperC action bar choice. The SuperC Compare Utility— New Data Set Specification panel appears with the data set information entered in it. Make sure the panel is filled in the way you want it to be.
3. Press Enter to display the *Old* SuperC comparison panel, and fill in the panel.
4. Press Enter again to submit the comparison.

For more information, see “SuperC utility (option 3.12)” on page 207.

SuperCE

Compare two data sets using extended options. For more information, see “SuperCE utility (option 3.13)” on page 217.

Search-For

Search data sets for strings of data. To SuperC search for strings of data:

1. Type the data set name in the Object name field or type an ISPF library name in the ISPF Library fields.
2. Select the Search-For action from the SuperC action bar choice. The Search-For Utility panel appears with the data set information entered in it. Make sure the panel is filled in the way you want it to be.

For more information, see “Search-For utility (option 3.14)” on page 230.

Search-ForE

Search a data set using extended options. For more information, see “Search-ForE utility (option 3.15)” on page 236.

Test

The Test action bar choice gives you access to the ISPF services that help you test dialogs, such as Chapter 9, “Dialog test (option 7),” on page 373. For more information, refer to the *z/OS ISPF Dialog Developer’s Guide and Reference*, and the *z/OS ISPF Edit and Edit Macros*.

The Test pull-down choices are:

Choice Description

Functions

Displays the Dialog Test Function/Selection panel. Select the Functions action from the Test action bar choice. For more information, see “Functions (option 7.1)” on page 381.

Panels Displays the Dialog Test Display panel. Select the Panels action from the Test action bar choice. For more information, see “Panels (option 7.2)” on page 384.

Variables

Displays the Dialog Test Variables panel. Select the Variables action from the Test action bar choice. For more information, see “Variables (Option 7.3)” on page 387.

Tables Displays the Dialog Test Tables panel. Select the Tables action from the Test action bar choice. For more information, see “Tables (option 7.4)” on page 391.

Log Displays the ISPF Transaction Log panel. Select the Log action from the Test action bar choice. For more information, see “Log (option 7.5)” on page 404.

Services

Displays the Invoke Dialog Service panel. Select the Services action from the Test action bar choice. For more information, see “Dialog services (option 7.6)” on page 407.

Traces Displays the Dialog Test Traces panel. Select the Traces action from the Test action bar choice. For more information, see “Traces (option 7.7)” on page 409.

Break Points

Displays the Dialog Test Breakpoints panel. Select the Break Points action from the Test action bar choice. For more information, see “Breakpoints (option 7.8)” on page 413.

Dialog Test

Displays the Dialog Test Primary Option panel. Select the Dialog Test action from the Test action bar choice. For more information, see Chapter 9, “Dialog test (option 7),” on page 373.

Dialog Test appl ID

Displays the Dialog Test Application ID panel for changing the Dialog Test application ID. Select the Dialog Test appl ID action from the Test action bar choice.

Help

The Help action bar choice provides access to the program tutorials.

Actions that require prompt windows for more information

Some actions that you call from the Workplace require additional information. You provide this information through the use of pop-up prompt windows. Some common actions of this type are:

- Resetting member statistics
- Using TSO commands
- Using WS commands
- Using the ISPF command shell
- Moving or copying data
- Renaming data sets

Here are the actions and the pop-up windows that accompany each one.

Resetting member statistics

Figure 242 shows the pop-up prompt window that appears when you choose Reset from the File action bar, after you choose a member to work with.

```

Menu Functions Confirm Utilities Help
Menu Functions Confirm Utilities Help
| r|=====|=====|=====|=====|=====|=====|=====|=====|=====|=====|
R -                                     Reset Member Statistics                                     - 03
C -                                     - GE
- Data Set Name:
S - 'JOHNLEV.TEST.DATA(EMP)'
-
- Options
- 1. Reset ISPF statistics
- 2. Delete ISPF statistics
-
- New Userid . . . _____ (If userid is to be changed)
- New Version . . . _____ (If version number is to be changed)
- New Mod . . . _____ (If mod number is to be changed)
- "/" to select . . _____ (If extended stats to be generated)
-
- Press ENTER to process action. Press CANCEL to cancel reset.
-
- F1=Help      F2=Split      F3=Exit      F7=Backward  F8=Forward
- F9=Swap      F12=Cancel
L|=====|=====|=====|=====|=====|=====|=====|=====|=====|=====|
F1=Help      F2=Split      F3=Exit      F5=Rfind    F7=Up      F8=Down      F9=Swap
F10=Left     F11=Right    F12=Cancel

```

Figure 242. Reset statistics panel (ISRURSET)

For more information about how the Reset statistics option works, see “Reset ISPF statistics utility (option 3.5)” on page 180. You can set these items from this window:

Options

Select 1 to Reset ISPF statistics, or 2 to Delete ISPF statistics.

New Userid

Sets the ID field in the statistics. If you want to change the ID the statistics are kept under, enter the new ID here. If you do not specify a new version number, this field is required to be filled in.

New Version

Enter a number here is you want to change the version number. This field is required if you do not enter a new userid. It is ignored if you have chosen the delete action.

New Mod

Enter a number here to change the version number.

“/” to select”

Select this option with a “/” to record extended ISPF statistics.

TSO command

Figure 243 on page 441 shows the pop-up prompt window that appears when you choose Command, from the File action bar choice, then select TSO Command from the Command Action prompt panel.

<u>M</u> enu	<u>F</u> unctions	<u>C</u> onfirm	<u>U</u> tilities	<u>H</u> elp
TSO Command Action				
The "/" character can be used within the command string to represent the following fully qualified and quoted data set name: 'MYPROJ.DEV.SOURCE(TEST)'				
Enter TSO Command and any additional parameters as needed: _____				
Press ENTER to execute command, press CANCEL to cancel action.				
F1=Help	F2=Split	F3=Exit	F7=Backward	F8=Forward
F9=Swap	F12=Cancel			
Command ==>			Scroll ==> PAGE	
F1=Help	F2=Split	F3=Exit	F5=Rfind	F7=Up
F10=Left	F11=Right	F12=Cancel	F8=Down	F9=Swap

Figure 243. TSO command panel (ISRUTCES)

You can set these items from this window:

TSO Command

The name of the TSO command you want to use. The command name can be followed by command parameters with the / character appearing anywhere within the parameter string.

WS command

Figure 244 on page 442 shows the pop-up prompt window that appears when you choose Command, from the File action bar choice, then select WS Command from the Command Action prompt panel. You must have a workstation connection in place in order to use WS commands.

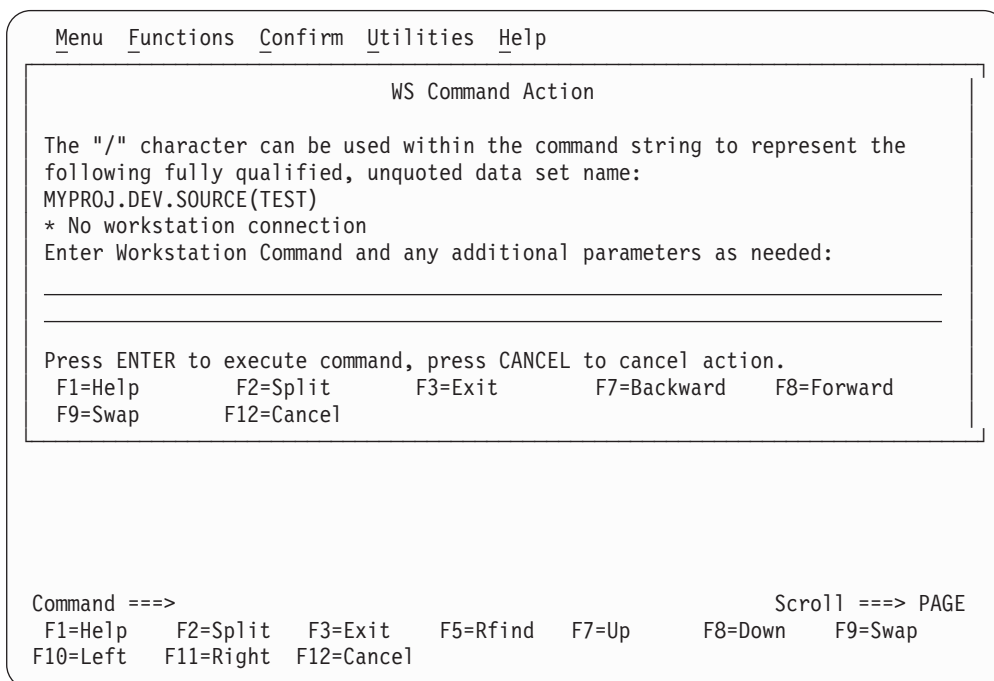

You can set these items from this window:

WS Command

The name of the WS command you want to use. The command name can be followed by command parameters with the / character appearing anywhere within the parameter string.

ISPF command shell

Figure 245 on page 443 shows the pop-up prompt window that appears when you enter the ISPF command shell. To get to this window, choose Command from the File action bar choice, then choose ISPF Command Shell on the Command Action prompt panel.

```

  Menu List Mode Functions Utilities Help
  _____
                        ISPF Command Shell
  Enter TSO or Workstation commands below:

  ===> _____
  _____

  Place cursor on choice and press enter to Retrieve command

  => xmit carvm3.userid da('userid.private.clist(types)')seq
  => status
  =>
  =>
  =>
  =>
  =>
  =>
  =>
  =>
  =>

  F1=Help      F2=Split      F3=Exit      F7=Backward  F8=Forward  F9=Swap
  F10=Actions  F12=Cancel

```

Figure 245. ISPF Command Shell panel (ISRTSO)

The ISPF Command Shell option enables you to run TSO commands, CLISTs, and REXX execs under ISPF. This panel has one input field. Type the command and its parameters into the input field, leaving at least one space between the command name and the first parameter. The input field continues for two full lines below the start of the input field. The maximum number of characters that you can enter is 234. For example:

Enter TSO or Work Station commands below

```

==> SEND 'THIS MESSAGE DEMONSTRATES THAT A TSO COMMAND ENTERED UNDER
ISPF CAN EXCEED ONE LINE ON THE 3270' USER(ALICE)

```

You can also enter ISPF commands, such as END or RETURN, in this field.

Note: If you enter HELP or CANCEL, it is interpreted as the ISPF Help or Cancel command. To issue TSO Help, enter:

```

==> TSO HELP xxxxx

```

To issue TSO Cancel, enter:

```

==> TSO CANCEL xxxxx

```

The ISPF command shell option enables you to enter most TSO commands under ISPF. Here is a list of commands that are not supported:

- LOGON
- LOGOFF
- ISPSTART, PDF, and ISPF
- TEST
- Commands that you are restricted from using by TSO
- Commands requiring large parameter lists (234 characters is the maximum allowed, including command name)

You can run command procedures under ISPF, subject to these restrictions:

- CLISTs and execs must not invoke restricted commands listed previously.

Workplace (Option 11)

- TERMIN command procedure statements are not supported.

These restrictions also apply to commands entered from other panels.

After you type a command in the input field, press ENTER to start the command. If you are not operating in Session Manager mode, the cursor is positioned below the command input field. Line-at-a-time I/O from the command, if any, starts at the cursor position. When the command finishes, three asterisks (***) may appear on the screen. To return to ISPF full-screen mode, press ENTER.

The ISPF command shell panel is then redisplayed with the command you entered displayed in the command list (unless you entered the TSO or WS prefix, or List mode is set to update off).

Move or copy

Figure 246 shows the pop-up prompt window that appears when you choose Move from the File action bar, after you choose a member to work with. The panel that appears when you choose Copy is similar to this one.

```
RefList Help
-----
                          MOVE Entry Panel
                                          More:  +
CURRENT from data set: 'MYPROJ.DEV.SOURCE(TEST)'
```

To Library	Options:
Project . . . MYPROJ	Enter "/" to select option
Group DEV	Replace like-named members
Type SOURCE	/ Process member aliases

To Other Data Set Name
Data Set Name . . . _____
Volume Serial . . . _____ (If not cataloged)

NEW member name . . . _____ (Blank unless member to be renamed)

Options		
Sequential Disposition	Pack Option	SCLM Setting
2 1. Mod	1 1. Default	3 1. SCLM
2 2. Old	2 2. Pack	2 2. Non-SCLM

Command ==>

F1=Help	F2=Split	F3=Exit	F7=Backward	F8=Forward	F9=Swap
F12=Cancel					

Figure 246. Move panel (ISRUMVC)

For more information about the Move/Copy utility, see “Move/Copy utility (option 3.3)” on page 133. You can set these items from this window:

To Library

The library to which you want to move or copy the selected data.

To Other Data Set Name

The data set to which you want to move or copy the selected data.

NEW member name

If the “To” and “From” data sets are the same, you can rename the member here.

Replace like-named members

Select this option to allow replacement of a member in the "To" data set with a like-named member in the "From" data set.

Process member aliases

Select this option to allow the primary member and all alias members to be moved together.

Sequential disposition

Select 1 if Mod, 2 if Old

- 1 Mod adds new data at the end of data currently contained in the data set.
- 2 Old begins placing new data at the beginning of the data set, writing over existing data.

Pack option

Indicates how you want the data to be stored in the "To" data set.

- 1 Data set is packed according to your default settings.
- 2 Data set is packed.

SCLM setting

Indicates how you want the data to be stored in the "To" data set.

- 1 SCLM
- 2 Non-SCLM
- 3 As is

Rename

Figure 247 shows the pop-up prompt window that appears when you choose Rename from the File action bar, after you choose a member to work with.

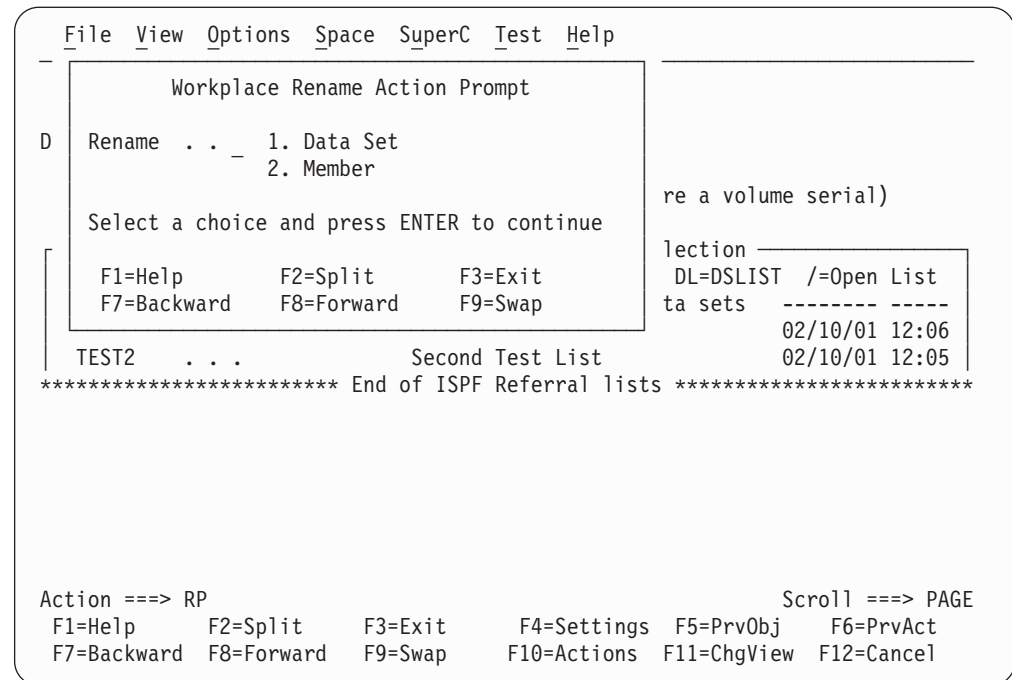

Figure 247. Rename prompt panel (ISRURNAM)

You choose to rename either a data set or a member from this panel. If you choose data set, the panel in Figure 248 on page 446 appears.

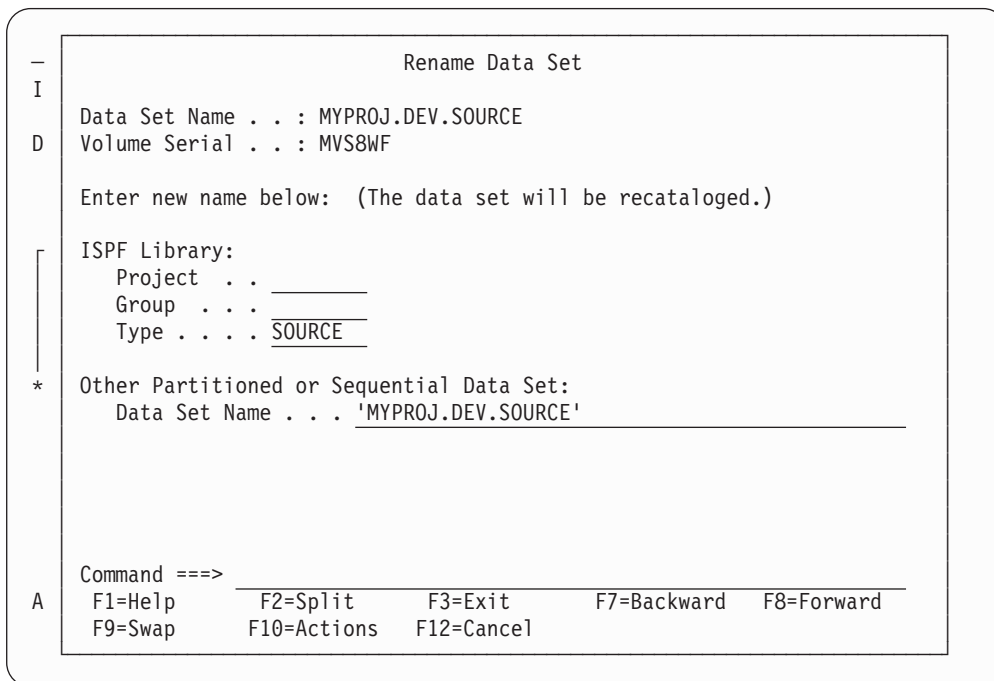

Figure 248. Rename data set panel (ISRUARP1)

You can set these items from this window:

New name

The name that you want to use for the renamed data set.

If you choose member, the panel in Figure 249 appears.

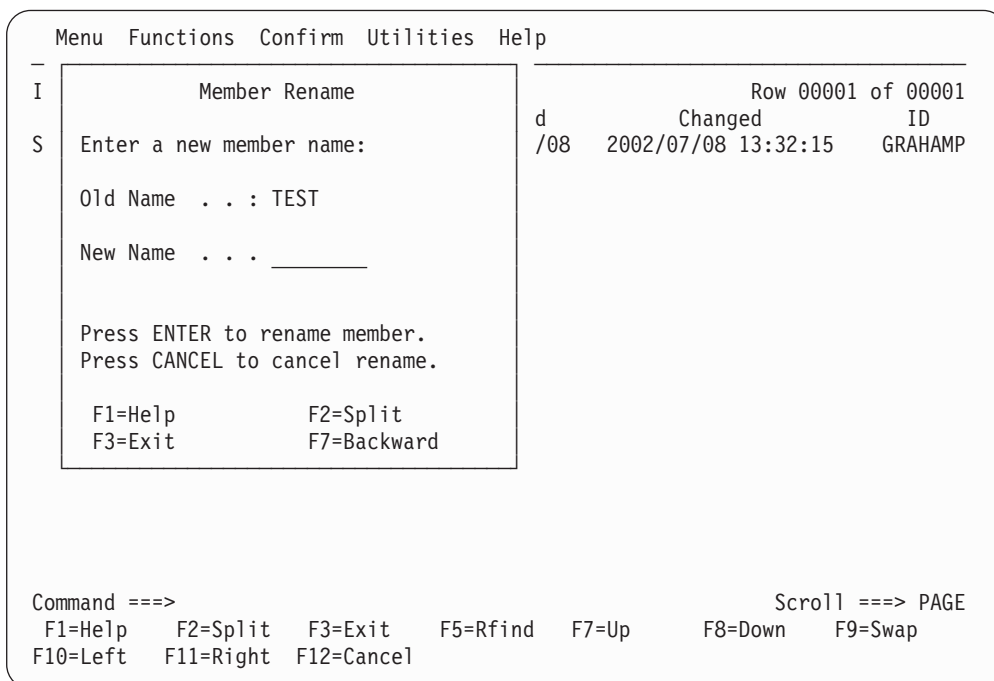

Figure 249. Rename member panel (ISRUREN)

You can set these items from this window:

New name

The name that you want to use for the renamed member.

Commands

You can use primary commands in the command area (Action line) of the Workplace entry panels.

You must be connected to the workstation to use any workstation file actions. You can configure your workstation editor choice by selecting the *Workstation* action bar from the Edit or View entry prompt panel or from the Workplace Settings panel.

Table 22. Workstation commands

Command	Description	Valid For:
A	Allocate	Data sets
ACTBAR or NOACTBAR	Display or do not display action bar on panel	Action prompt
AP	Allocate	Action prompt
B	Browse	Members and non-PDS data sets
C	Copy	Members and non-PDS data sets
COLOR	Global color change	Action prompt
CP	Command	Action prompt
CUAATTR	CUA attributes	Action prompt
D	Delete	Members and non-PDS data sets
DF	Delete	Data sets
DL	DSLIST	Data set name level
DP	Delete	Action prompt
DVT	VTOC summary	Data summary
E	Edit	Members and non-PDS data sets
EP	Edit	Action prompt
G	Reset member statistics	Members
I	Full information	Data sets
ICS	ISPF command shell	Action prompt
ICT	ISPF command table	Action prompt
IP	Information	Action prompt
J	Submit	Members and non-PDS data sets
K	Catalog	Data sets
KEYLIST	Keylist utility	Action prompt
L	Print data set	Data sets
LOCATE, LOC, or L	Find a specified referral list in the scrollable display of referral lists	Referral lists
LP	List	Action prompt
LV or LISTVIEW	List view	Action prompt
M	Move	Members and non-PDS data sets
ML	Member list	Partitioned data sets
N	Rename	Data sets
O	Open	Members and non-PDS data sets
OPD	Personal data set lists	Referral lists
OPL	Personal library lists	Referral lists
P	Print	Members and non-PDS data sets

Workplace (Option 11)

Table 22. Workstation commands (continued)

Command	Description	Valid For:
PDL	Print data set list	Data sets
PP	Print	Action prompt
PSCOLOR	Point and shoot	Action prompt
PVT	Print VTOC information	Data sets
Q	VSAM	Data sets
R	Rename	Members and non-PDS data sets
RP	Rename	Action prompt
S	Short information	Data sets
SC	SuperC	Data sets
SCE	SuperC extended	Data sets
SELECT, SEL, or S	Select a specified referral list in the scrollable display of referral lists	Referral lists
SETTINGS	ISPF settings	Action prompt
SF	SearchFor	Data sets
SFE	SearchFor extended	Data sets
T	TSO command	Members and non-PDS data sets
U	Uncatalog	Data sets
V	View	Members and non-PDS data sets
VP	View	Action prompt
W	WS command	Members and non-PDS data sets
WE	Workstation file, edit on host	Workstation files
WEW	Workstation file, edit on workstation	Workstation file
WPSET	Workplace settings	Action prompt
WV	Workstation file, view on host	Workstation files
WVV	Workstation file, view on workstation	Workstation files
X	Print data set index	Data sets
Y	Allocate SMS (enhanced)	Data sets
Z	Compress	Data sets
= (equal sign)	Repeat last command. If no previous action, <i>view</i> is the default.	Members and non-PDS data sets

Default CUA function key settings

Table 23 shows how the function keys are defined for the main Workplace panel when the mode is set to keylist ON and function keys are set to primary LOWER.

Table 23. Workplace function key settings

Key	Action	Description:
F1	Help	Workplace help
F2	Split	Split screen
F3	Exit	Exit Workplace
F4	Settings	ISPF Workplace settings
F5	PrvObj	Recall last object
F6	PrvAct	Repeat last action
F7	Backward	Scroll up Replist

Table 23. Workplace function key settings (continued)

Key	Action	Description:
F8	Forward	Scroll down Refflist
F9	Swap	Swap screen
F10	Actions	Cursor to action bar
F11	ChgView	Change Workplace view
F12	Cancel	Exit Workplace
F13	Help	Help
F14	Split	Split
F15	End	End
F16	Return	Return
F17	Rfind	Repeat find
F18	Rchange	Repeat change
F19	Up	Up (Scroll up)
F20	Down	Down (Scroll down)
F21	Swap	Swap
F22	Left	Left (Scroll left)
F23	Right	Right (Scroll right)
F24	Cretriev	Cursor/retrieve

Changing workplace settings

Figure 250 on page 450 shows the pop-up prompt window that appears when you choose the Workplace Settings pull-down from the Options choice on the Workplace action bar. You can also start this function by entering WPSET on the command line. The workplace settings determine how your particular workplace behaves for various functions.

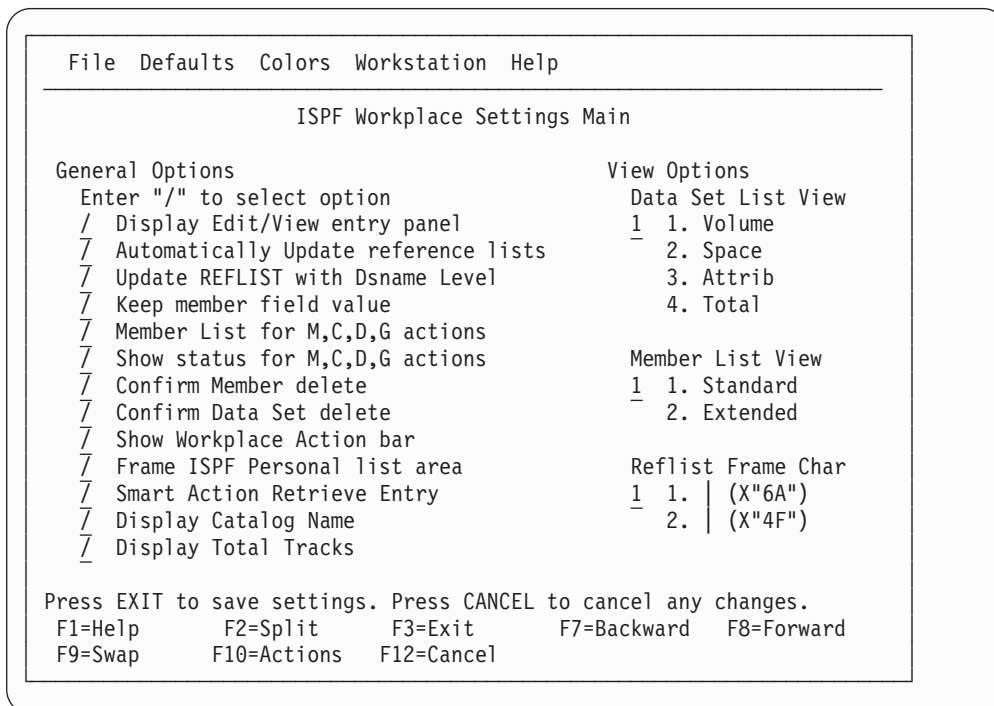

Figure 250. Workplace Settings panel (ISRUSETM)

You can set these items from this window:

Display Edit/View entry panel

When selected, causes the Edit/View prompt panel to appear before you can start an edit or view action for a sequential data set. If you want to display a member list, the prompt panel is only displayed if a slash (/) is entered in the Prompt field of the member list.

The default for this setting is *selected*.

Automatically Update reference lists

When selected, specifies that any data set or library, or both, is added to the respective reference list.

The default for this setting is *selected*.

Update REFLIST with Dsname Level

When selected, specifies that the ISPF Reference List is updated with the Dsname pattern entered in Object Name.

Keep member field value

When selected, specifies that the member name field for ISPF Library is not to be cleared upon return from a library action.

The default for this setting is *selected*.

Member List for M,C,D,G actions

When selected, specifies that the actions Move, Copy, Delete, and Reset result in a member list. When not selected, these actions act upon all members that match the pattern without displaying a member list.

The default for this setting is *selected*.

Show status for M,C,D,G actions

When selected, displays a status panel for the actions Move, Copy, Delete, and Reset. When not selected, no status panel is displayed.

The default for this setting is *selected*.

Confirm Member delete

When selected, specifies that the delete confirmation panel is displayed before a member is deleted.

The default for this setting is *selected*.

Confirm Data Set delete

When selected, specifies that the delete confirmation panel is displayed before a data set is deleted.

The default for this setting is *selected*.

Show Workplace Action bar

When selected, specifies that the action bar appears on the workplace panels.

The default for this setting is *selected*.

Frame ISPF Referral list area

When selected, specifies that the ISPF referral list area be framed, using the character specified in the Replist Frame Char field.

Smart Action Retrieve Entry

When selected, specifies that ISPF executes the smart action option against the retrieved data set.

Display Catalog Name

When selected, specifies that the Total view of a Data Set List displays the catalog name in which the data set was located.

Display Total Tracks

When selected, specifies that a Total Tracks header line is displayed on the data set list above the column headings for the Space and Total view.

View Options

Specifies how to display the data set list.

volume

Displays data set list with a volume view.

space Displays data set list with a space view.

attrib Displays data set list with an attribute view.

total Displays data set list in total view.

Member List View

Specifies how to display the member list

standard

Displays a member list with a 1-character command entry field.

extended

Displays a member list with an 8-character command entry field.

Replist Frame Char

The character used to frame the ISPF referral list area on your workstation panels.

Workplace Settings panel action bar

These action bar choices appear on the Workplace Settings panel:

File The file pull-downs give you the options to either cancel or exit the current file.

Workplace (Option 11)

Defaults

You can choose the default enter or open actions from these pull-downs:

Default Enter action

You can select a default action to perform automatically whenever you do an Enter action. The available actions are:

- Smart Action

The Smart Action enables ISPF to choose the action needed based on the characteristics of the object you are using. ISPF chooses the appropriate action according to these rules:

Object type

Action selected by ISPF

ISPF Library

Member list

Partitioned Data Set

Member list

Pattern containing "*" or "%"

Data Set List

Volume (with no object name)

Data Set List

Member Object

User selectable *

Sequential Data Set

User selectable *

Workstation File

User selectable *

* Use the Smart Action action bar choice to select the action for member objects, sequential data sets and workstation files.

- Member List
- Data Set List
- Edit
- View
- Browse
- Rename member
- Move
- Copy
- Reset Stats
- Open
- Repeat action

Default Open action

You can select a default action to perform automatically whenever you do an Open action from the Workplace or workplace member lists. The available actions are:

- User command (a user defined command)
- Edit
- View
- Browse
- Delete member
- Rename member
- Move
- Copy
- Reset member
- Print member
- WS Cmd
- TSO Cmd

Colors You can choose the colors for the member list or the data set list from this action bar.

Workstation

You can connect your host and workstation with these choices:

1. Configure ISPF Workstation Tool Integration
2. ISPF C/S Install

Help Provides general workplace settings help, and default enter and open help.

Workplace example scenario

The scenario here illustrates some of the advantages provided by the ISPF Workplace function. To provide you with a reference point of view, the scenario includes points on how you can accomplish the same task using ISPF in the traditional way.

For this example, say that your task is to:

1. Copy a sequential data set into a member of a concatenated ISPF Library.
2. SuperC compare it to another member.
3. Rename the member.
4. Change the Version number in the ISPF statistics.

Subtask 1

Your first step is to copy a sequential data set into a member of a concatenated PDS.

Traditional ISPF

Use the 3.3 Move/Copy Utility.

Workplace

Use the Copy Action against the sequential data set object.

Choose the Workplace option (Option 11) on the main menu. Use the PF11 key to toggle to the data set view. In the Workplace you have a choice of working from a data set list or issuing commands against a single data set.

If you are list-oriented you can specify a wildcard character in the Object Name field (such as, 'USERID.*') to generate a data set list containing the sequential data set.

If you prefer to specify the sequential data set directly you can type it into the Object Name field either with or without single quotes (that is, SEQ.FILE or 'USERID.SEQ.FILE').

In either case these accelerated methods can be alternatives to remembering and typing the input:

- You might be able to retrieve a recently referenced data set name or pattern from the REFLIST in the bottom half of the Workplace.
- You might be able to retrieve a recently referenced data set name or pattern using the recall key PF5.
- You might be able to retrieve a data set name or pattern from a personal list you previously created. These also appear in the bottom half of the Workplace.

Workplace (Option 11)

Now that the Object has been specified you must specify the Action. In this example, the action is COPY. You can do this several ways, depending on your preferences.

- If you are in a list, you can use the CO line command to copy the data set, or you can put a slash (/) in the line command field to be prompted with a list of available commands to select.
- If you specified the "from" data set directly (not from a list) you can use the Copy option from the File action bar choice, or you can type the C fast path command in the Action ==> field to copy the data set.

In either case, a pop-up panel prompts you for the target data set, member name, and other parameters.

Subtask 2

The second step is to SuperC compare one member of a concatenated PDS to another.

Traditional ISPF

Use the 3.13 SuperC compare utility.

Workplace

Use the Workplace-to-SuperC Interface.

Using PF11, toggle back to the Workplace ISPF Library View.

Specify the ISPF library concatenation and member name of the new member you just created by the COPY action. These accelerated methods can be used as alternatives to remembering and typing the input:

- You might be able to retrieve a recently referenced ISPF Library concatenation from the REFLIST in the bottom half of the Workplace.
- You might be able to retrieve a recently referenced ISPF Library concatenation using the recall key PF5.
- You might be able to retrieve an ISPF Library concatenation from a personal list you previously created. These also appear in the bottom half of the Workplace.

Now that the Object has been specified you must specify the Action. The action at this point is SuperCE. Again, specifying this action can be done several ways depending on your preferences.

- You can use the SuperCE option from the SuperC action bar.
- You can type the "SCE" fast path command in the Action ==> field and press Enter.

In either case, Workplace enters the SuperCE dialog. Note that your ISPF Library concatenation is transferred to the correct New DSN fields in the SuperCE concatenation panel, so you do not have to type it yourself.

After running your compare, exit the SuperC Utility to return to Workplace.

Subtask 3

The next step is to rename a member of an ISPF Library.

Traditional ISPF

Use the 3.1 Library Utility.

Workplace

Use the Rename member Action.

The ISPF library concatenation and member name of the new member you just compared remains on the Workplace panel. Now you must specify the Rename Action.

How do you prefer to do this?

- You can use the Rename option from the File action bar.
- You can type the "R" fast path command in the Action ==> field, then press Enter.
- You can work from a member list and issue the "R" line command to rename the member.

Member lists can be created a number of ways in Workplace:

- Just press Enter if your default enter action is Smart Action, a mode that analyzes the object and selects an appropriate action. Select the Workplace Settings option from the Options action bar to view or change your defaults.
- Enter the List option from the File action bar.
- Enter the "ML" fast path command.

In any case, Workplace displays a pop-up panel to prompt you for the new member name.

Subtask 4

The final step in this scenario is to change a member's Version number in the ISPF statistics.

Traditional ISPF

Use the 3.5 Reset Statistics Utility.

Workplace

Use the Reset Action.

The ISPF library concatenation and member name of the new member you just compared remains on the Workplace panel. Now you must specify the Reset Action.

Again you have a choice about how to do this:

- You can use the Reset option from the File action bar.
- You can type the "G" fast path command in the Action ==> field and press Enter.
- You can work from a member list and issue the "G" line command to rename the member or specify the "/" line command to be prompted with an action selection list.

Workplace (Option 11)

In all cases, Workplace displays a pop-up panel to prompt you for Reset parameters.

Appendix A. SuperC reference

This topic provides information about the SuperC return codes, process options, update data set control options, and process statements.

ISPF contains two utilities, SuperC (option 3.12) and SuperCE (option 3.13), that allow you to compare data sets for differences. Also, ISPF contains two other utilities, Search-For (option 3.14) and Search-ForE (option 3.15), that allow you to search data sets for strings of data.

All four of these utilities combine two major components to do their respective functions. The first component is a dialog that provides the data entry panels, selection panels, and messages. The second component is the program module, ISRSUPC. The CPI interface is through a standard parameter list.

You can use the SuperC program without the ISPF utilities. To do this, however, your installation must customize a CLIST or REXX exec (for interactive use), or a PROCLIB procedure (for batch processing of a catalog procedure). A sample CLIST has been provided to show line command processing. A sample PROCLIB JCL catalog procedure has also been provided to show batch submission. The sample CLIST and PROCLIB JCL are located in the ISP.SISPSAMP PDS data set as members ISRSCLST and ISRSPROC, respectively.

Utility differences

The standard utilities, SuperC (option 3.12) and Search-For (option 3.14), are easy to use with somewhat reduced function. The extended utilities, SuperCE (option 3.13) and Search-ForE (option 3.15), fully exploit the SuperC program's capabilities.

Standard utilities

The standard utilities are useful for ordinary comparisons and searches. The SuperC utility (option 3.12) uses a two-panel sequence: you specify the new input data set on the first panel and the old input data set on the second. The Search-For utility (option 3.14) uses an optional two-panel sequence: you can specify the input data set and one search string on the first panel, and use the second panel if you need to specify more than one search string.

You can enter additional information on these panels as they are displayed. If you are using the SuperC utility, you can enter the name of a previously prepared profile data set that contains additional information to specify the comparison.

Search-For does not use a profile data set. Also, Search-For finds all occurrences without case distinction when searching for a data string.

Extended utilities

The primary intent of the extended utilities is to provide maximum flexibility and access to all SuperC functions. Input fields are provided to allow you to use process options and statements. Also, the Search-ForE utility's ASIS fields allow you to specify mixed-case search strings.

The input data set name fields differ from standard ISPF format because Project, Group, Type, and Member fields are not provided. Instead, you can enter input

SuperC - utility differences

data set names horizontally using standard TSO naming conventions. This includes the use of a PDS member name, if desired, as part of a data set name.

The concatenation of input data sets is also different. Up to four data set names, as opposed to the standard four ISPF library groups, can be entered as new or old data sets. This allows data sets with the same attributes to be concatenated. For example, PANELS and MSGS data sets could be concatenated for searching.

Besides compare functions, the SuperCE Utility panel provides access to the Search-ForE utility (option 3.15). This gives you the added advantage of the ability to search for a data string without having to leave SuperCE, in addition to access to more functions than Search-For (option 3.14) provides.

Program description

The SuperC program is a fast and versatile program that can process:

- Two sequential data sets
- Two complete partitioned data sets
- Members of two partitioned data sets
- Concatenated data sets.

In fact, any data set that can be processed by ISPF can be processed by the SuperC program.

Note: SuperC does not support tape data sets.

SuperC can compare data sets even when there are many differences and redundant data. Some examples of redundant data are blank lines, duplicate words, and binary data with many duplicate characters.

Unlike many compare programs, SuperC is not limited to comparing data sets on a line-by-line basis. Instead, it allows you to choose between the four comparison levels listed. The compare type you select determines which kinds of data differences are presented by SuperC. See "Reasons for differing comparison results" on page 495 for more information about comparison results.

- File comparisons produce summary information about the differences between the data sets being compared.
- Line comparisons are record-oriented and show matching, inserted, deleted, and reformatted lines. This level is most useful for comparing lines of program source code. It provides the least output difference information and is least sensitive to resynchronization.
- Word comparisons show differences between data strings that are delimited by blanks or nonalphanumeric characters, such as commas. Matching words are found, even if they are not on the same line. This level is most useful for comparing text data sets.
- Byte comparisons determine byte differences. It is most useful for comparing unformatted and machine-readable data.

The SuperC program requires only the names of the input data sets. However, the utility you are using may require other information, such as a listing type. Also, you can enter these types of processing information and options on the utility data entry panels:

- Compare type
- Listing data set name or destination
- Process options

- Statements or profile data set name
- Browse output choice.

The SuperC program allows you to create two kinds of output:

- A listing that shows the results of the comparison or search and
- A structured data set that contains update information.

Within these two categories, you can create many kinds of output that make it easy to see where your data differs. To see your comparison results, you can generate listings that show:

- An overall summary of total changes
- The actual source code where deltas (differences) were found
- The deltas plus up to 10 (the default) matching lines before and after
- The deltas plus all matching lines.

You can format the listings to show differences either sequentially or side-by-side.

In an update data set, output lines are identified and results are put in specific columns. An update data set is especially useful as input to a user-written application program. It allows a program to customize what you see, changing generalized output to information that is specific to a particular application.

The SuperC utility (options 3.12, 3.13, and 3.14) CLISTs allocate or free space under these DDNAMEs: SYSIN, SYSIN2, OLDDD, NEWDD, OUTDD, and DELDD.

SuperC features for the year 2000 transition

SuperC includes features designed to help manage the Year 2000 transition:

- Specify a 100-year period (or “year window”) so that, for dates that have only a 2-digit year, the century can be determined. This can be based on either:
 - A “fixed” year window (with a fixed starting year), or
 - A “sliding” year window (starting at a specified number of years before the current year).
- Compare 2-digit year values in one data set with 4-digit year values in another data set.
- Compare compressed year values in one data set with uncompressed year values in another data set.
- Filter cosmetic differences caused by adding century digits to 2-digit years, so that you can more easily identify real differences in content.

Applications

You can use the SuperC program for many applications other than comparing two source data sets. This topic lists some specific applications for general users, writers and editors, and programmers and systems administrators.

General users can:

- Compare two data sets that have been reformatted. Reformatted data sets contain such differences as indentation level changes, spaces inserted or deleted, or lines that have been reformatted and moved to other parts of the data set.

SuperC detects and classifies reformatted lines as special changes. You can list these lines in the output, along with the normal insert/delete changes, or eliminate them from the listing. Reducing the number of flagged lines may help you focus on real, rather than cosmetic, changes.

SuperC - applications

- Determine whether two PDSs, or a concatenation of PDSs, have corresponding like-named members.

Members absent from one data set but present in the other are listed, as is all change activity between like-named members. The comparison can show changes caused by creating or deleting PDS members.

Writers and editors can:

- Detect word changes within documents.
SuperC finds word differences even if the words have moved to different lines.
- Verify that only designated areas are changed.
SuperC comparison results show all areas affected. Changes made to restricted areas may be invalid. Therefore, unintended changes can be detected so that a complete document need not be checked for errors again.
- Create a utility that automatically inserts SCRIPT revision codes.
You could write a program that uses Word compare to find where words in the new data set are different, makes a copy of the new data set, and then inserts SCRIPT revision codes (.RC) before and after the changed words. This utility could eliminate the need to insert SCRIPT revision codes manually.

Programmers and systems administrators can:

- Generate management reports that show the quantity and type of changes in program source code.
SuperC can count the changed and unchanged lines of code in an application program. Therefore, comparison results could be used to summarize the changes between different versions of a program.
- Retain a record of change activity.
Listing data sets can be collected and retained as a permanent record of the changes made before a new program is released. Source code differences can help detect regressions or validate the appropriateness of any code modifications.
- Rewrite a listing data set, including additional headers or change delimiters.
Some SuperC listings may need to be rewritten before you accept the results. For example, some installations may require security classifications. Others may require a listing created using the WIDE process option to have box delimiters surrounding changed sections.
- Compare data sets across nonconnected systems.
SuperC can generate a 32-bit hash sum per data set or member using the File compare type. Data sets compared on a nonconnected processor, using SuperC, should have the same hash sums if they are identical. A File comparison of any data set to determine a hash sum can be done by specifying the same data set as both new and old.
- Develop additional uses for update data sets.
SuperC produces general results with generalized reports. However, your installation may have additional requirements. There are many specialized update formats that you can use to produce listings that match these requirements. Normal SuperC listings may not fit this type of application, but the update data sets are more structured and should be easier to use as data input. See Appendix C, "Update files," on page 527 for explanations and examples of the update data sets.

Process options

Option P on either the SuperCE Utility panel or the Search-ForE Utility panel provides one or more panels from which you can select process options. For SuperCE, the options displayed are compatible with the compare type (File, Line, Word, or Byte) that you specified in the Compare Type field. The compare type that you select determines the available process options (Table 24).

Table 24. Summary of process options

Process option		Valid for compare type				Valid for Search
Keyword	Description	FILE	LINE	WORD	BYTE	
ALLMEMS	All members	✓	✓	✓	✓	✓
ANYC	Any case		✓	✓		✓
APNDLST	Append listing output	✓	✓	✓	✓	✓
APNDUPD	Append update		✓	✓	✓	✓
I ASCII	Convert input file data from EBCDIC to ASCII	✓	✓	✓	✓	✓
CKPACKL	Check for packed format		✓	✓		
CNPML ¹	Count non-paired member/file lines		✓			
COBOL ²	For COBOL source files		✓	✓		✓
COVSUM	Conditional summary	✓	✓	✓	✓	
I CPnnnnn	EBCDIC code page used with ASCII option	✓	✓	✓	✓	✓
DLMDUP	Do not list matching duplicate lines		✓			
DLREFM	Do not list reformatted lines		✓			
DPACMT	Do not process asterisk (*) comment lines		✓	✓		✓
DPADCMT	Do not process ADA-type comments		✓	✓		✓
DPBLKCL	Do not process blank comparison lines		✓	✓		✓
DPCBCMT	Do not process COBOL-type comment lines		✓	✓		✓
DPCPCMT	Do not process C++ -type comment lines		✓	✓		✓
DPFTCMT	Do not process FORTRAN-type comment lines		✓	✓		✓
DPMACMT	Do not process PC Assembly-type comment lines		✓	✓		✓
DPPLCMT	Do not process PL/I-type comments		✓	✓		✓
DPPSCMT	Do not process Pascal-type comments		✓	✓		✓
FINDALL	Require all strings found for return code 1					✓
FMSTOP	Stop immediately a difference found	✓				
FMLNS	Flag moved lines		✓			
GWCBL	Generate WORD/LINE comparison change bar listing		✓	✓		
IDPFX	Identifier-prefixed listing lines					✓
LMCSFC ³	Load module CSECT file compare	✓				
LMT0 ⁴	List group member totals					✓
LNFMTO ⁴	List not-found member totals only					✓
LOCS	List only changed entries in summary	✓	✓	✓	✓	
LONGLN ⁵	Long lines		✓			✓
LPSF ⁴	List previous-search-following lines					✓

Compare - process options

Table 24. Summary of process options (continued)

Process option		Valid for compare type				Valid for Search
Keyword	Description	FILE	LINE	WORD	BYTE	
LTO ⁴	List totals only					✓
MIXED	Mixed input (single/double byte) text		✓	✓		
NARROW ⁵	Narrow (side-by-side) listing		✓			
NOPRTCC	No printer control columns	✓	✓	✓	✓	✓
NOSEQ ²	No sequence numbers		✓	✓		✓
NOSUMS	No summary section		✓	✓	✓	✓
REFMOVR	Reformat override		✓			
SDUPM	Search duplicate members					✓
SEQ ²	Ignore standard sequence number columns		✓	✓		✓
SYSIN	Provide alternative DD name for process statements.	✓	✓	✓	✓	✓
UPDCMS8 ⁶	Update CMS8 format		✓			
UPDCNTL ⁶	Update control		✓	✓	✓	
UPDLDEL ⁶	Update long control		✓			
UPDMVS8 ⁶	Update MVS8 format		✓			
UPDPDEL ⁶	Update prefixed delta lines		✓			
UPDREV ⁶	Update revision		✓	✓		
UPDREV2 ⁶	Update revision (2)		✓	✓		
UPDSEQ0 ⁶	Update sequence 0		✓			
UPDSUMO ⁶	Update summary only		✓	✓	✓	
VTITLE	Print data set volume serial		✓	✓	✓	
WIDE ⁵	Wide (side-by-side) listing		✓			
XREF	Cross reference strings					✓
XWDCMP	Extended word comparison			✓		
Y2DTONLY ⁷	Compare Dates Only		✓			

Note:

- Valid for group LINE comparisons only.
- COBOL, SEQ, and NOSEQ are mutually exclusive.
- Not supported for PDSE data sets.
- LMTO, LNFMT0, LPSF, and LTO are mutually exclusive.
- LONGLN, NARROW, and WIDE are mutually exclusive.
- All update (UPD) process options are mutually exclusive. Also, they cannot be used with the process option Y2DTONLY.
- Y2DTONLY is not supported for change bar listing (process option GWCBL).

Here are the SuperC process options, listed alphabetically:

ALLMEMS

Process all members in a PDS including ALIAS members. Without this process option, when performing a PDS compare, SuperC does not include members with the ALIAS attribute unless explicitly specified by a SELECT

process statement. The ALLMEMS process option indicates that all directory entries including those with the ALIAS attribute are to be processed.

Valid for FILE, LINE, WORD, and BYTE compare types and Search.

ANYC Any case. Lowercase alphabetic characters (a to z) in source files are translated to uppercase (A to Z) before comparison processing. (The actual input files are not modified.)

Use this option to cause strings such as "ABC", "Abc", "ABc", to compare equally.

Valid for LINE and WORD compare types and Search.

APNDLST

The APNDLST process option appends the listing output to the specified or default listing file. If the file does not exist, it is created.

APNDLST allows you to collect updates from multiple comparisons into one listing file.

Valid for FILE, LINE, WORD, and BYTE compare types and Search.

Note:

1. You can also do this by using the SELECT process statement (and, on CMS, SELECTF) that identifies different files/members and produces a single listing.

APNDUPD

The APNDUPD process option appends the update output to the specified or default update file. If the file does not exist, it is created.

APNDUPD allows you to collect updates from multiple comparisons into one update file.

Valid for LINE, WORD, and BYTE compare types and Search.

Note:

1. You can also do this by using the SELECT process statement (and, on CMS, SELECTF) that identifies different files/members and produces a single listing.

ASCII Process ASCII input files. For LINE or WORD compare and for Search the input data is translated from ASCII to EBCDIC. For BYTE compare, character data in the listing is translated from ASCII to EBCDIC. For FILE compare, this option is accepted but has no effect. Any search string given in hexadecimal notation is assumed to be in ASCII, matching the original input data.

The ASCII code page is assumed to be ISO 8859-1 (CCSID 819). The EBCDIC code page may be specified using the Cpnnnnn option.

Valid for FILE, LINE, WORD, and BYTE compare types, and Search.

CKPACKL

Check for packed format. This option determines if the member or sequential data set has the standard ISPF/PDF packed header format. If required, SuperC unpacks the input data set or member during the comparison.

Valid for LINE and WORD compare types.

Compare - process options

CNPML

Count non-paired member/file lines for the group summary list. Use this option to inventory the total number of processed and not-processed lines. Otherwise, only the paired entries are listed with line counts.

Valid for LINE compare type.

Note: CNPML is only used when comparing a *group* of files.

COBOL

Ignore columns 1 to 6 in both COBOL source files. Data in columns 1 to 6 is assumed to be sequence numbers.

Valid for LINE and WORD compare types and Search.

COVSUM

Conditional summary section. List the final summary section or the update file for the option UPDSUMO only if there are differences. This is useful when used in combination with APNDLST or APNDUPD.

Valid for FILE, LINE, WORD, and BYTE compare types.

CPnnnnn

Use the specified EBCDIC code page number (up to 5 digits) when translating data using the ASCII option. If not specified ISPF uses the terminal code page. If the terminal code page cannot be determined or is not supported SuperC uses CP1047. All CECF and Euro Latin-1 code pages are supported. Therefore nnnnn can be any of the following values:

Default: 1047 (Open Systems Latin-1 EBCDIC)

CECF: 37, 273, 277, 278, 280, 284, 285, 297, 500, 871

ECECF (Euro): 1140 to 1149

Valid for FILE, LINE, WORD, and BYTE compare types, and Search.

DLMDUP

Do not list matching duplicate lines. *Old* file source lines that match *new* file source lines are omitted from the side-by-side output listing.

Valid for LINE compare type.

DLREFM

Do not list reformatted lines. *Old* file source lines that have the same data content (that is, all data is the same except the position and number of space characters) as the *new* file lines are omitted from the listing. Only the *new* file reformatted lines are included in the output.

Valid for LINE compare type.

DPACMT

Do not process asterisk (*) comment lines. Lines with an "*" in column 1 are excluded from the comparison set. Other forms of assembler comments are unaffected.

Valid for LINE and WORD compare types and Search.

DPADCMT

Do not process ADA type comments. ADA comments are whole or partial lines that appear after the special "--" sequence. Blank lines are also considered part of the comment set. This option produces a comparison listing with comments removed and part comments blanked.

Valid for LINE and WORD compare types and Search.

DPBLKCL

Do not process blank comparison lines. Source lines in which all the comparison columns are blank are excluded from the comparison set.

Note: It is redundant to use this option with DPADCMT, DPPLCMT, or DPPSCMT as these process options also bypass blank comparison lines.

Valid for LINE and WORD compare types and Search.

DPCBCMT

Do not process COBOL-type comment lines. COBOL source lines with an "*" in column 7 are excluded from the comparison set

Valid for LINE and WORD compare types and Search.

DPCPCMT

Do not process C++ end-of-line type compiler comments. These are "//" delimited comments. DPPLCMT may also be used with DPCPCMT when the source file contains "/* ... */" comments delimiters.

Valid for LINE and WORD compare types and Search.

DPFTCMT

Do not process FORTRAN-type comment lines. FORTRAN source lines with a "C" in column 1 are excluded from the comparison set.

Valid for LINE and WORD compare types and Search.

DPMACMT

Do not process PC Assembly-type comments. This uses the IBM PC definition for assembler comments: comments begin with either the COMMENT assembler directive or a semi-colon (;).

Valid for LINE and WORD compare types and Search.

DPPLCMT

Do not process PL/I-type comments. PL/I, C++, C, REXX comments (/* ... */) and blank lines are excluded from the comparison set. This option produces a listing with all comments removed and blanked.

Valid for LINE and WORD compare types and Search.

DPPSCMT

Do not process Pascal-type comments. Comments of the type (* ... *) and blank lines are excluded from the comparison. DPPSCMT and DPPLCMT may be required for some Pascal compiler comments. This option produces a comparison listing with comments removed and part comments blanked.

Valid for LINE and WORD compare types and Search.

FINDALL

All strings must be satisfied for the search to be considered successful, whereupon the return code is set to one.

Note:

1. If all searches are not satisfied, there is NO message to indicate this, other than RC=0. To find which searches failed, specify the XREF process option.
2. If the FMSTOP option is specified, the search will stop once it has satisfied all search strings.

Compare - process options

FMSTOP

Immediately a difference is found between files, stops the compare with a return code of 1. This option provides a quicker way of telling if two files are different.

Valid for FILE compare type.

FMVLNS

Flag moved lines. Identify inserted lines from the *new* file that match deleted lines from the *old* file. Inserted-moved lines are noted with "IM" and deleted-moved lines are noted with "DM" in the listing.

Valid for LINE compare type.

Note:

1. Maximum length for lines is 256 characters.
2. Maximum length for a contiguous block of moved lines is 32K.

GWCBL

Generates WORD/LINE comparison change bar listings. SuperC lists *new* file lines with change bars ("|") in column 1 for lines that differ between the *new* and *old* files. Deleted lines are indicated by flagging the lines following the deletion.

Valid for LINE and WORD compare types.

Note:

1. LINE comparison and WORD comparison may give slightly different results due to their sensitivity to word and line boundaries. For further details, see "Reasons for differing comparison results" on page 495.
2. GWCBL cannot be used with the process option Y2DTONLY.

IDPFX

Identifier prefixed. File ID or member name is prefixed to the search string lines of the listing. See Figure 273 on page 523 for an example of a IDPFX listing.

Valid for Search.

LMCSFC

Load module CSECT file compare list. Lists the name, number of bytes, and hash sum for each load module CSECT. Unchanged paired CSECTs are omitted when you specify the LOCS process option.

Note:

1. LMCSFC is not supported for PDSE.

Valid for FILE compare type.

LMTO

List group member totals. Lists the member summary totals and the overall summary totals for the entire file/group. See Figure 275 on page 524 for an example of an LMTO listing.

Valid for Search.

LNFMTO

List "not found" member totals only. Lists the members that have no strings found for the entire file/group.

Valid for Search.

LOCS List only changed entries in summary. Normally, for *groups* of files/members being compared, SuperC lists all paired entries in the Member Summary Listing section of the listing file. Preceding the names of these pairs is a CHNG field to indicate whether the comparison found any differences or not. Figure 262 on page 515 shows a FILE comparison without LOCS. Figure 263 on page 516 shows a FILE comparison with LOCS.

When LOCS is specified, only those pairs which have changes are listed in the summary section.

Valid for group FILE, LINE, WORD, and BYTE compare types.

LONGLN

Long lines. LONGLN causes SuperC to create a listing with 203 columns, reflecting up to 176 columns from the source files. This file may exceed the maximum number of columns handled by many printers.

Valid for LINE compare type and Search.

LPSF List previous-search-following lines. Lists the matched string line and up to 6 preceding and 6 following lines for context. The preceding and following count may be changed by using the LPSFV process statement. This allows a count range of 1 to 50 lines. A value of 0 is invalid, since this produces a normal search without any options.

Valid for Search.

LTO List totals only. List the overall summary totals for the entire file/member group. See Figure 277 on page 525 for an example of an LTO listing.

Valid for Search.

MIXED

Mixed input. Indicates that the input text may be a mixture of both single-byte and double-byte (DBCS) text. Double-byte strings are recognized and handled differently than if MIXED were not specified. For instance, single byte characters are not valid within double-byte strings. Special terminal devices (for example, 5520) allow entry of DBCS characters.

Valid for LINE and WORD compare types.

NARROW

Narrow side-by-side listing. Creates a 132/133 variable listing file with only 55 columns from each source file. Insertions and deletions are flagged and appear side-by-side in the listing output. Refer to Figure 259 on page 512 and Figure 260 on page 513 for examples of NARROW listings.

Valid for LINE comparison.

NOPRTCC

No printer control columns. SuperC generates "normal" or NARROW listing files with record lengths of 133 columns, or WIDE or LONGLN listing with 203 columns. These listings contain printer control columns and page separators. NOPRTCC eliminates both the page separators and page header line. With NOPRTCC, "normal" and NARROW listings are 132 columns, and WIDE and LONGLN listings are 202. Section separators and title lines are still generated. This file may be preferred for on-line "browsing".

Valid for FILE, LINE, WORD, and BYTE compare types and Search.

Compare - process options

NOSEQ

No Sequence numbers. Process fixed-length 80-byte record standard sequence number columns (73 to 80) as data. This option is extraneous for any record size other than 80.

Valid for LINE and WORD compare types and Search.

NOSUMS

No Summary Section. Eliminates the group and final summary section from the output listing. This allows the user to generate a better "clean" copy for program inspection. Conversely, it eliminates the all-problem information in case of errors and option identification.

Valid for LINE, WORD, and BYTE compare types and Search.

REFMOVR

Reformat override. Reformatted lines are not flagged in the output listing. They are, however, counted for the overall summary statistics and influence the return code since they are a special case of an insert/delete pair.

Valid for LINE compare type.

SDUPM

Search duplicate members. Searches all members found in concatenated PDS data sets, even if more than one member is found to have the same name. Searches duplicate names even if the search is for a single member or if members are specified using the SELECT process statement.

Valid for Search.

SEQ

Sequence numbers. Ignore fixed-length 80-byte record standard sequence number columns. Sequence numbers are assumed in columns 73 to 80 for such records. This option is invalid for any record size other than 80.

Valid for LINE and WORD compare types and Search.

SYSIN

Provide alternate DD name for process statements. Syntax is SYSIN(DDNAME). The default ddname is SYSIN. If this option is used, SuperC only accesses process statements via the supplied ddname. It does not attempt to access additional process statements via the SYSIN2 DD card.

Valid for FILE, LINE, WORD, and BYTE compare types and Search.

UPDCMS8

Update CMS 8 format. UPDCMS8 produces an update file that contains both control records and source lines from the *new* input file. UPDCMS8 requires that the *old* file has fixed-length 80-byte records with sequence numbers. The *new* file may have a variable or fixed length format with an LRECL ≤ 80.

SuperC may change the status of match lines to insert/delete pairs, enlarging the sequence number gaps of the *old* file. The update file (when properly named) can be used as input to CMS XEDIT. For information and an example of this update file, see "Update CMS sequenced 8 file" on page 529.

Valid for LINE compare type.

UPDCNTL

Update Control. Produces a control file which relates matches, insertions,

deletions, and reformattings using relative line numbers (for LINE compare type), relative word positions (for WORD compare type), or relative byte offsets (for BYTE compare type) within the *new* and *old* file. No source or data from either input file is included in the output file. “Do not” process options/statements are compatible selections for the LINE compare type. For information and an example of this update file, see “Update control files” on page 530.

Valid for LINE, WORD, and BYTE compare types.

UPDLDEL

Update Long Control with all matches and delta changes. This reflects the comparison's matches, inserts, and deletes. You can edit this update file accepting, rejecting, or modifying the changes.

There are control records preceding each change and matching section. After the changes have been audited, optionally modified, and the control records removed, you should be able to reuse this control file as a composite new file.

Valid for LINE compare type.

UPDMVS8

Update MVS8 format. Produces a file that contains both control and *new* file source lines. Sequence numbers from columns 73 to 80 of the *new* file are used (when possible) as insert references, while deletes use sequence numbers from columns 73 to 80 of the *old* file. Both files must have fixed-length 80-byte records. The format of the generated data may be suitable as z/OS IEBUPDTE input. For information and an example of this update file, see “Update MVS sequenced 8 file” on page 534.

Valid for LINE compare type.

UPDPDEL

Update prefixed delta lines. Produces a control data set containing header records and complete (up to 32K line length limit) delta lines from the input source files. Each output record is prefixed with identification and information. The update data set is a variable-length data set reflecting the input source files' characteristics.

Valid for LINE compare type.

UPDREV

Update Revision. UPDREV produces a copy of the *new* file with SCRIPT/VS *.rc on/off* or BookMaster® *:rev/:erev* revision codes delimiting most script lines that contain changes.

You may wish to contrast the source lines delimited by the UPDREV option and a similar flagging of the lines with changes from the output listing file as produced by the GWCBLL process.

Note: The revision character used is controlled by using the REVREF process statement. For details, see “Revision code reference” on page 486.

A REVREF process statement (for example, REVREF REFID=ABC or REVREF RCVL=1) defines the revision level (SCRIPT/VS tags) or reference ID (BookMaster tags). Alternatively, SCRIPT/VS *.rc* delimiters may be controlled by the first record in the *new* file. (For example, *.rc 2 |* as the first record causes level 2 to be used).

Compare - process options

Note: BookMaster requires the REFID value to be defined with a *:revision* tag and "RUN=YES" attribute to have the change character inserted in the processed document.

For information and an example of this update file, see "Revision file" on page 528.

Valid for LINE and WORD compare types.

UPDREV2

Update Revision (2). UPDREV2 is identical to UPDREV with the exception that data between the following BookMaster tags are not deleted in the update file:

:cgraphic.
:ecgraphic.

:fig.
:efig.

:l1b1box.
:el1b1box.

:nt.
:ent.

:screen.
:escreen.

:table.
:etable.

:xmp.
:exmp.

Valid for LINE and WORD compare types.

UPDSEQ0

Update Sequence 0 (zero). UPDSEQ0 produces a control file that relates insertions and deletions to the relative line numbers of the *old* file. Both control records and *new* file source lines are included in the output file. This option is like UPDCMS8 except that it uses relative line numbers (starting with zero) instead of the sequence numbers from columns 73 to 80. The control field after a "\$" designates the number of new source lines that follow in the update file.

Both fixed and variable record length lines are allowed. Fixed-length records shorter than 80 bytes are padded with spaces to 80. Insertion lines are full fixed or variable length copies of the new input data set lines. For information and an example of this update file, see "Update sequenced 0 file" on page 536.

Valid for LINE compare type.

UPDSUMO

Update Summary only. UPDSUMO produces an update file of 4 lines (new file ID, old file ID, totals header, single summary line). The summary line is tagged with a "T" in column 1 and the summary statistics are located at fixed offsets in the output line. The file has a record length of 132. For information and an example of this update file, see "Update summary only files" on page 537.

Valid for LINE, WORD, and BYTE compare types.

VTITLE

Volume title. VTITLE modifies the compare listing so that the data set volume serial is printed below the data set name.

For a multi-volume data set only the VOLSER of the first volume is displayed.

VTITLE is ignored if the NTITLE or OTITLE process option is specified.

Valid for LINE, WORD, and BYTE compare types.

WIDE Wide side-by-side listing. Creates a 202/203 variable-length listing file with 80 columns from each source file. Inserts and deletes are flagged and appear side-by-side in the listing output. For an example of a WIDE side-by-side listing, see Figure 261 on page 514.

Valid for LINE compare type.

XREF Cross reference strings. Creates a cross reference listing by search string. Can be used with IDPFX, LMTO LNFMT0, and LTO. Not implemented for LPSF.

The XREF option can be useful when more than one search string (or search condition) is specified. The XREF listing is implemented using a multiple pass operation for listing the "lines found" for each individual string. Be aware that XREF adds some additional processing overhead to the normal search process. For an example of a search XREF listing, see Figure 269 on page 520.

Valid for Search.

XWDCMP

Extended WORD comparison. The word delimiter set is extended to include non-alphanumeric characters (including spaces). For example, "ABCD(EFGH) JKL" is 2 words using normal WORD compare type, but 5 (3 words and 2 pseudo-words) with the XWDCMP process option.

Valid for WORD compare type.

Y2DTONLY

Compare Dates Only. Indicates that the comparison process is to be performed only on the dates defined by the Date Definition process statements. That is, all data in the input files is ignored in the comparison process apart from that defined by NY2C, NY2Z, NY2D, NY2P, OY2C, OY2Z, OY2D, and OY2P process statements. For further details on these process statements, see "Date definitions" on page 492.

Note:

1. Y2DTONLY causes a "record-for-record" comparison to be performed between the two input files, whereby dates are checked for being equal or unequal. (The "high/low" comparison logic that SuperC normally uses is not applied in the case of Y2DTONLY and, as such, the relative *values* of the dates have no bearing on the result of the comparison.)
2. Y2DTONLY is not supported for the process option GWCBL (change bar listing).

Valid for LINE compare type.

Process statements

You can use process statements to tailor your comparison or search according to your requirements. Process statements provide a powerful and flexible way of ensuring that only relevant data is compared (or searched) and that meaningful results are produced.

Broadly speaking, the two major functions that process statements perform are:

- To *select* the data that is to be compared (or searched) and,
- To handle various *date formats*.

All process statements require a keyword followed by one or more operands. They are supplied to SuperC in the Process Statements File.

Table 25 lists each of the process statement keywords and shows for which compare type each keyword can be used. The table also shows whether the keyword is valid for the SuperC Search.

Note: The sequence in which each of the process statements is listed (in Table 25 and the pages following) is primarily alphabetic according to the process statement keyword.

However, in the interest of keeping associated “pairs” and “sets” of process statements together, the prefixes “N” and “O” (indicating the process statement applies to the new or old file) have been ignored when sequencing the process statements alphabetically.

Table 25. Summary of process statements

Process option		Valid for compare type				Valid for Search
Keyword	Description	FILE	LINE	WORD	BYTE	
NCHGT	Change text: new or search file		✓	✓		✓
OCHGT	Change text: old file		✓	✓		
CHNGV	Change listing value		✓	✓	✓	
CMPBOFS	Compare byte offsets				✓	
CMPCOLM	Compare (search) columns: new, old, search files		✓	✓		✓
CMPCOLMN	Compare columns: new file		✓	✓		
CMPCOLMO	Compare columns: old file		✓	✓		
CMPLINE	Compare lines		✓	✓		✓
CMPSPECT ¹	Compare sections		✓	✓		
COLHEAD ²	Define column headings		✓			
DPLINE	Do not process lines (containing a string)		✓	✓		✓
DPLINEC	Do not process lines continuation		✓	✓		✓
NEXCLUDE ⁴	Exclude data: new file	✓	✓			
OEXCLUDE ⁴	Exclude data: old file	✓	✓			
NFOCUS ⁴	Focus on data: new file	✓	✓			
OFOCUS ⁴	Focus on data: old file	✓	✓			
LNCT	Line count	✓	✓	✓	✓	✓

Table 25. Summary of process statements (continued)

Process option		Valid for compare type				Valid for Search
Keyword	Description	FILE	LINE	WORD	BYTE	
LPSFV	List previous-search-following value					✓
LSTCOLM	List columns		✓			✓
REVREF	Revision code reference		✓	✓		
SELECT	Select PDS members (z/OS)	✓	✓	✓	✓	✓
SELECT	Select members/files (CMS)	✓	✓	✓	✓	✓
SELECT	Select members (z/VSE®)	✓	✓	✓	✓	✓
SLIST	Statements listing option	✓	✓	✓	✓	✓
SRCHFOR	Search for a string					✓
SRCHFORC	Search for a string continuation					✓
NTITLE	Alternative listing title: new file	✓	✓	✓	✓	✓
OTITLE	Alternative listing title: old file	✓	✓	✓	✓	
NY2AGE	Aging option: new file		✓			
OY2AGE	Aging option: old file		✓			
NY2C	Date definition: new file, character format		✓			
NY2Z	Date definition: new file, zoned decimal format		✓			
NY2D	Date definition: new file, unsigned packed decimal format		✓			
NY2P	Date definition: new file, packed decimal format		✓			
OY2C	Date definition: old file, character format		✓			
OY2Z	Date definition: old file, zoned decimal format		✓			
OY2D	Date definition: old file, unsigned packed decimal format		✓			
OY2P	Date definition: old file, packed decimal format		✓			
WORKSIZE	Maximum number of units for comparison		✓	✓	✓	
Y2PAST	Global date option		✓			
*	Process Statement comment to be printed	✓	✓	✓	✓	✓
.*	Process Statement comment not to be printed	✓	✓	✓	✓	✓

Note:

1. Not supported on CMS.
2. Valid only for listing types DELTA and LONG.
3. Supported only on z/VSE.
4. FILE compare type is valid only with ROWS option of NEXCLUDE, OEXCLUDE, NFOCUS, and OFOCUS.
5. Supported only on CMS.

The following sections describe each process statement in detail.

Change listing value

Change listing value

The CHGNV process statement specifies the number of match lines listed before and after a line with a change: insert, delete, or reformat.

Compare Types: LINE, WORD, and BYTE

►►—CHGNV—*number*—

number

A decimal number between 1 and 1000.

Example

Description

CHGNV 3

Lists up to 3 lines before and after change.

Change text

There are two Change Text process statements:

NCHGT

Change new (or search) input text string

OCHGT

Change old input text string

These process statements change the input source image before performing the comparison.

The relative input file ("new" or "old") is scanned for text that matches a *search_string*. If matching text is found, it is replaced by a corresponding *output_string* before the comparison process is performed. Question marks ("?") may be used as "wildcard" characters in the *search_string* or *output_string*.

The *search_string* and *output_string* need not be the same length. The *output_string* may even be a null string.

Compare Types: LINE, WORD, and Search. OCHGT cannot be used for Search.

►►—NCHGT—'—*search_string*—',—'—*output_string*—'

—*start_column*—
—:*last_start_column*—

search_string

A character or hexadecimal string to be replaced in the input file. For one embedded apostrophe, use two consecutive apostrophes (').

output_string

The replacement string to be used in the comparison. For one embedded apostrophe, use two consecutive apostrophes (').

start_column

The column in or after which the *search_string* must start. Must be greater than zero.

last_start_column

The last column in which the *search_string* may start. Must be separated from the *start_column* by a colon, and must be equal to or greater than the *start_column* value. If not supplied, is the equivalent of setting the value to *start_column*. To search from the *start_column* to the end of a variable length row, set the *last_start_column* to a value larger than the length of the longest row.

Example**Description**

NCHGT 'ABCD', 'XXXX'

Changes all strings "ABCD" in the new file to "XXXX" before performing the comparison.

OCHGT 'ABCD', 'XXXX', 1:50

Changes all strings "ABCD" in the old file, that start within columns 1 to 50, to "XXXX" before performing the comparison.

OCHGT 'ABCD', '', 1:50

Changes all strings "ABCD" in the old file, that start within columns 1 to 50, to a null string before performing the comparison. (In the comparison process, this effectively ignores any "ABCD" strings found in those positions in the old file.)

NCHGT 'ABCD', 'AB'

Changes all strings "ABCD" in the new file to "AB" before performing the comparison.

NCHGT X'7B01', ':1', 6

Changes all hexadecimal strings X'7B01' in the new file, that start in column 6, to the character string ":1" before performing the comparison.

NCHGT 'PREF???' , 'NPREF'

Changes all 7-character strings with the prefix "PREF" in the new file, to the 5-character string "NPREF" before performing the comparison.

NCHGT 'PREF???' , 'NPREF??'

Changes the first 5 characters of all 7-character strings with the prefix "PREF" in the new file, to "NPREF" before performing the comparison.

Comment lines

There are two tags that if found at the start of a line turn it into a comment line:

- * An asterisk as the first character on a process statement line begins a printable comment line.
- .* A period-asterisk as the first two characters on a process statement line begins a comment that is not printed in the SuperC listing.

Compare Types: FILE, LINE, WORD, BYTE, and Search

- * Must be in column 1.
- .* Must be in columns 1 and 2.

Example**Description**

Comment lines

- * This comment prints in the SuperC listing.
- . * This comment does not print in the SuperC listing.

Compare byte offsets

The CMPBOFS process statement compares a file between byte limits. The start and stop reference values must be hex values. The statement may be specified on one complete line or may have separate CMPBOFS statements for each of the six keyword operands: TOP, BTM, NTOP, NBTM, OTOP, and OBTM.

Compare Type: BYTE

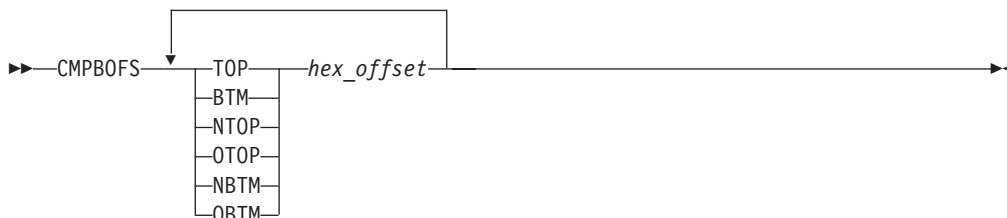

keyword

The keyword may have one of the following values:

- TOP** Top. Defines the first byte offset position in the *new* and *old* byte compare file. Means both NTOP and OTOP. The lowest byte position is at offset zero.
- NTOP** New Top. Defines the first byte offset position in the *new* file for the byte compare.
- OTOP** Old Top. Defines the first byte offset position in the *old* file for the byte compare.
- BTM** Bottom. Defines the last byte position in the *new* and *old* byte compare file. Means both NBTM and OBTM.
- NBTM**
New Bottom. Defines the ending point in the *new* file for the compare.
- OBTM**
Old Bottom. Defines the ending point in the *old* file for the compare.

hex_offset

A hexadecimal value. Do not put in apostrophes, or 'bracket' it within "X'...'".

Example

Description

CMPBOFS NTOP 1000 OTOP 5E00

Compare the new file from hex offset X'1000' (to the end of file) with the old file from hex offset X'5E00' (to the end of file).

CMPBOFS NTOP 1000CMPBOFS OTOP 5E00

These two separate process statements have the same effect as the "combined" statement above.

Compare (search) columns

There are three Compare Columns process options:

CMPCOLM

Applies to both the new and old files, or search file

CMPCOLMN

Applies to the new file

CMPCOLMO

Applies to the old file

These options compare (or search) the data between column limits of the input files (or search file). Up to 15 compare ranges or individual columns are allowed and may be entered on additional CMPCOLM, CMPCOLMN, or CMPCOLMO statements. All specified ranges of columns must be in ascending order.

Compare Types: LINE and WORD CMPCOLM is also valid for Search.

Note:

1. Some process options (SEQ, NOSEQ, and COBOL) also specify columns. The CMPCOLM, CMPCOLMN, CMPCOLMO process statements override all these process options.
2. CMPCOLM, CMPCOLMN, CMPCOLMO cannot be used for WORD compare type or Search if the input contains a *mixture* of DBCS and non-DBCS data.

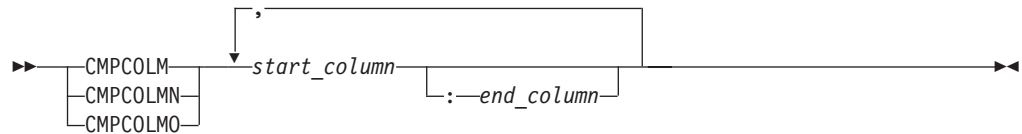

start_column

The starting column number to be compared or searched.

end_column

The ending column number of the range of columns to be compared or searched. (Must be separated from the *start_column* by a colon.)

Example

Description

CMPCOLM 25:75

Compare columns 25 through 75 in both files (or search columns 25 through 75 in the search file).

CMPCOLM 30:60,75

Compare columns 30 through 60 and column 75 in both files (or search columns 30 through 60 and column 75 in the search file).

CMPCOLMN 48:54

Compare columns 48 through 54 in the new file.

CMPCOLMO 87

Compare column 87 in the old file.

CMPCOLMN 17:22CMPCOLMO 15:20

Compare columns 17 through 22 in the new file with columns 15 through 20 in the old file.

Compare lines

Compare lines

The CMLINE process statement compares two files (or search) between line limits. The statement may be specified on one complete line or may have separate CMLINE statements for each of the six keyword operands: TOP, BTM, NTOP, NBTM, OTOP, and OBTM. The reference values may be line numbers or data strings.

Compare Types: LINE, WORD, and Search

Note: Keyword operands OTOP and OBTM are invalid for Search.

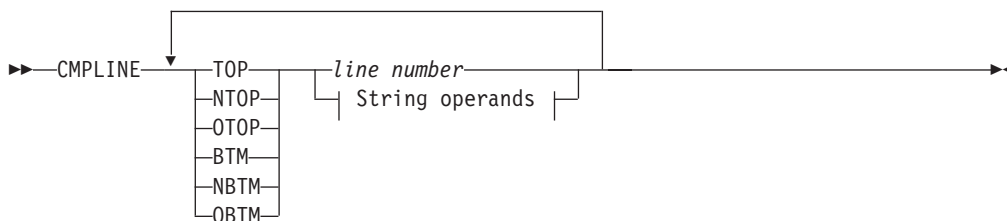

String operands:

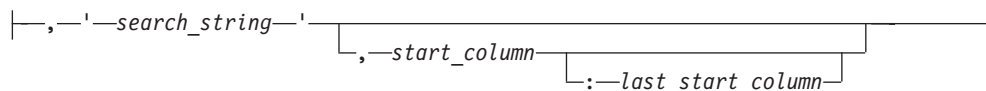

keyword

The keyword may have one of the following values:

TOP Top. Defines the beginning line in the *new* (or search) file and *old* compare file. Means both NTOP and OTOP.

NTOP New Top. Defines the beginning line in the *new* (or search) file.

OTOP Old Top. Defines the beginning line in the *old* file.

BTM Bottom. Defines the ending line in the *new* (or search) file and *old* compare file. Means both NBTM and OBTM.

NBTM New Bottom. Defines the ending line in the *new* (or search) file.

OBTM Old Bottom. Defines the ending line in the *old* compare file.

line number

The relative number of the record in the file.

search_string

A character or hexadecimal string enclosed within apostrophes. For one embedded apostrophe, use two consecutive apostrophes (").

start_column

The column in or after which the *search_string* must start.

last_start_column

The last column in which the *search_string* may start. Must be separated from the *start_column* by a colon.

Example

Description

CMPLINE TOP 55 BTM 99

Compare from line 55 to line 99 in both files.

CMPLINE NTOP 55 NBTM 99

Compare from line 55 to line 99 in the new file.

CMPLINE NTOP 'ABCD',5:66

Compare from where "ABCD" starts within columns 5 to 66 in new file (that is, is found within columns 5 to 69).

CMPLINE OTOP 'ABCD'

Compare from where "ABCD" first found in old file.

CMPLINE TOP X'40E2',1:1

Compare from where "S" is found for both files.

Compare sections

The CMPSECT process statement compares multiple sections from one sequential data set or PDS member to another sequential data set or PDS member. It is not valid for a PDS group comparison of more than one member. It is functionally similar to CMPLINE but allows you to divide the input into one or more *sections* for subsequent comparison or searching. A section ID name is needed to associate all keyword operands to a particular section. Thus, multiple sections of the input can be compared (or searched) in a single execution of SuperC.

Compare Types: LINE, WORD, and Search

Note:

1. CMPSECT is not supported for CMS.
2. Keywords OTOP and OBTM are invalid for Search.

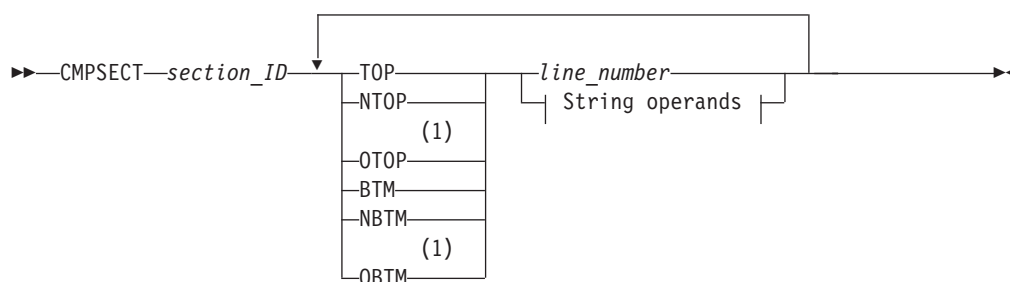

String operands:

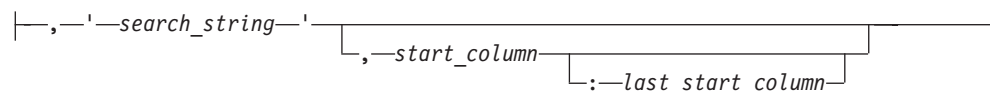

Notes:

- 1 Invalid for Search-For.

section_ID

A character string identifier (up to 8 alphanumeric characters, no

Compare sections

embedded spaces, can start with a numeric) relating to a section (group of lines). It allows multiple keywords to be associated with the same section.

keyword

The keyword may have one of the following values:

TOP Top. Defines the beginning line in the *new* (or search) file and *old* compare section. Means the same as NTOP and OTOP.

NTOP New Top. Defines the beginning line in the *new* (or search) section.

OTOP Old Top. Defines the beginning line in the *old* section.

BTM Bottom. Defines the ending line in the *new* (or search) file and *old* compare section. Means both NBTM and OBTM.

NBTM

New Bottom. Defines the ending line in the *new* (or search) section.

OBTM

Old Bottom. Defines the ending line in the *old* compare section.

line_number

The line number associated with the **keyword**.

string A character or hexadecimal string enclosed within apostrophes. For one embedded apostrophe, use two consecutive apostrophes ("").

start_column

The column in or after which the *search_string* must start.

last_start_column

The last column in which the *search_string* may start. Must be separated from the *start_column* by a colon.

Note: If a "top" condition is not found (for example, a pattern is incorrect), the compare continues but normally reports zero lines processed for this data set.

Example

Description

CMPSECT SECT01 TOP 25 BTM 50

Compares lines 25 through 50 in both data sets or members.

CMPSECT SECT02 NTOP 60 NBTM 70CMPSECT SECT02 OTOP 65 OBTM 75

Compares lines 60 through 70 in the new data set to lines 65 through 75 in the old data set.

CMPSECT SECTX TOP 'PART1:',2:10CMPSECT SECTX BTM 'END PART1:',2:10

Starts the comparison of both data sets when SuperC detects the string "PART1:" starting in columns 2 through 10 and ends the comparison when SuperC detects the string "END PART1:" starting in columns 2 through 10.

CMPSECT SECTY NTOP 'PART2:',2:10 CMPSECT SECTY OTOP 'PART2:',6:20 CMPSECT SECTY BTM 'END PART2:'

Compares a section in the new data set to a section in the old data set. The section in the new data set begins with the string "PART2:" in columns 2 through 10 and ends with the string "END PART2:" in columns 2 through 10. The section in the old data set begins with the string "PART2:" in columns 6 through 20 and ends with the string "END PART2:" in columns 2 through 10.

Note: All the previous statements could be combined to compare multiple sections of the new and old data sets.

Define column headings

The COLHEAD process statement defines column headings and specifies the location and format of the corresponding data to be displayed. For an example of a listing with column headings, see Figure 258 on page 512.

Note: COLHEAD is not available for side-by-side listings. (See “NARROW” process option).

Compare Type: LINE

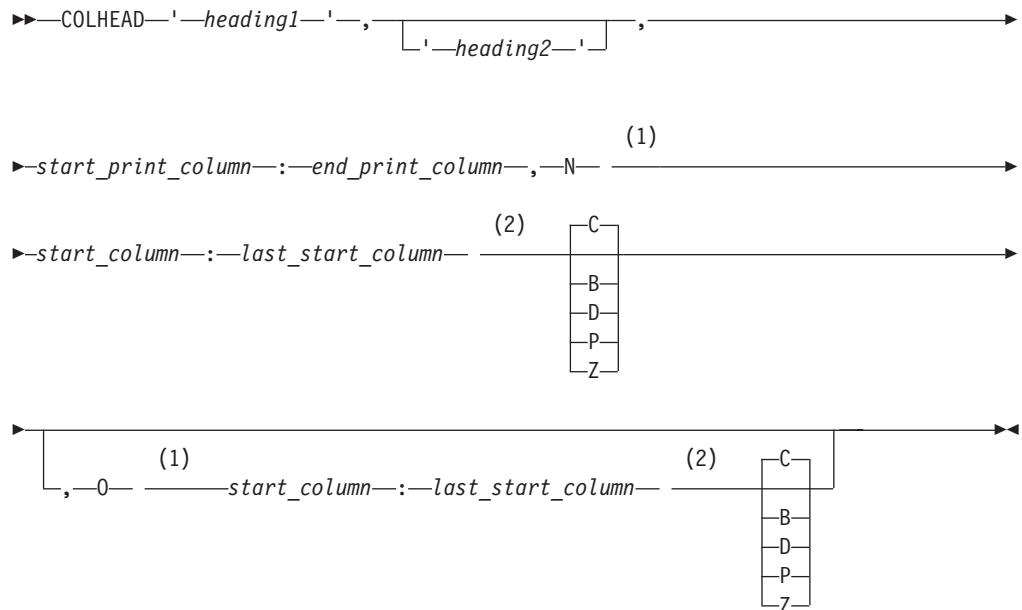

Notes:

- 1 N and 0 must be followed by a space.
- 2 C, B, D, P, or Z must be preceded by a space.

heading1

The heading to appear on the first line for the print column.

heading2

The heading to appear on the second line for the print column.

start_print_column

The starting print column for the heading specified.

end_print_column

The ending print column for the heading specified. (Must be separated from the *start_print_column* by a colon.)

Note: If the print-column range is shorter than the heading specified, the heading is truncated.

N Indicates the operands following relate to the *new* file.

start_column

The starting position in the *new* file of the data to be displayed.

Define column headings

last_start_column

The ending position in the *new* file of the data to be displayed. (Must be separated from the *start_column* by a colon.)

Data Format Indicator

The format of the data in the *new* file to be displayed:

C Character
B Binary
D Unsigned packed decimal
P Packed decimal
Z Zoned decimal

O Indicates the operands following relate to the *old* file.

start_column

The starting position in the *old* file of the data to be displayed.

last_start_column

The ending position in the *old* file of the data to be displayed. (Must be separated from the *start_column* by a colon.)

Data Format Indicator

The format of the data in the *old* file to be displayed (as for the *new* file).

Example

Description

```
COLHEAD 'START', 'DATE', 1:7, N 1:6 P, 0 11:16
```

Defines a print column with a heading of "START" in the first line and "DATE" in the second heading line, headings to start in print column 1. The data to be displayed from the new file is in positions 1 through 6 and is in packed format. The data to be displayed from the old file is in positions 11 through 16 and is in (the default) character format.

Do not process lines

There are two Do Not Process Lines process statements:

DPLINE

Do not Process Lines

DPLINEC

Do not Process Lines Continuation

These options remove from the compare (or search) set all lines that can be recognized by either a unique character string or combination of related strings all appearing on the same input line. DPLINEC is the continuation of the immediately preceding DPLINE or DPLINEC process statement. All the strings in a DPLINE/DPLINEC group must be found on the same input line.

A *start_column* or *start-range* can also be used to restrict the columns. Relative *start_columns* and *start-ranges* are valid only on DPLINEC statements.

Compare Types: LINE, WORD, and Search

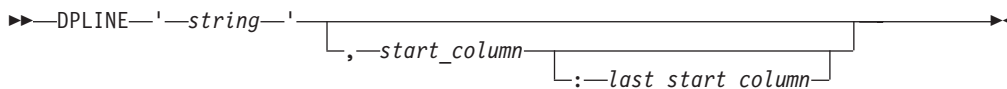

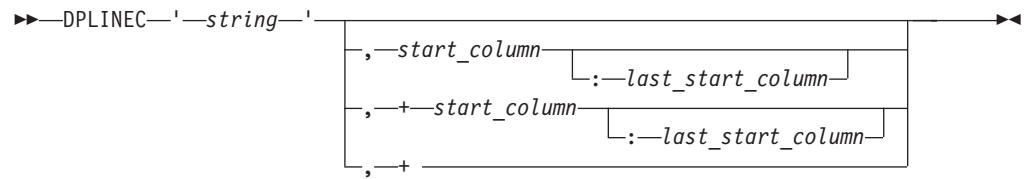

string A character or hexadecimal string enclosed within apostrophes. For one embedded apostrophe, use two consecutive apostrophes (").

start_column

The column in, or after which, the string must start.

last_start_column

The last column in which the string may start. (Must be separated from the *start_column* by a colon.)

+start_column

The relative column, following the location of the previous string (as specified in the previous DPLINE or DPLINEC statement), in, or after which, this string must start.

last_start_column

The relative last column, following the location of the previous string (as specified in the previous DPLINE or DPLINEC statement), in which this string may start.

+ The specified string may appear anywhere following the location of the previous string (as specified in the previous DPLINE or DPLINEC statement).

Example

	Description
DPLINE 'ABCDE'	Scans all columns for string "ABCDE"
DPLINE 'AbCde',2	Scans only column 2 for start of string "AbCde"
DPLINE 'AbCde',2:2DPLINEC 'BDEF'	Same as above example. String "BDEF" must be on the same line as the string "AbCde"
DPLINE 'ABCDE',2:50	Scans only columns 2 through 50 for start of string "ABCDE"
DPLINE 'AB'CD',2:50	Scans only columns 2 to 50 for start of string "AB'CD"
DPLINE X'C1C27BF1',2:50	Scans only columns 2 to 50 for start of hexadecimal string X'C1C27BF1'
DPLINE 'ABC'DPLINEC 'BDEF',+	Scans for string "ABC"; if found, then scans for string "BDEF" in the same line (following "ABC")
DPLINE 'ABC'DPLINEC 'BDEF',+5	Scans for string "ABC"; if found, then scans for string "BDEF" starting in the 5th column after the starting column of "ABC"

Do not process lines

DPLINE 'ABC'DPLINEC 'BDEF',+5:12

Scans for string "ABC"; if found, then scans for string "BDEF" starting anywhere in the 5th to 12th columns after the starting column of "ABC"

Exclude data

There are two Exclude Data process statements:

NEXCLUDE

Exclude applies to the new file

OEXCLUDE

Exclude applies to the old file

These statements exclude rows or columns of data from the comparison. Up to 254 "exclude" statements can be entered for each file.

Note:

1. NEXCLUDE and OEXCLUDE statements are mutually exclusive to NFOCUS and OFOCUS statements if using the same operand keyword (ROWS or COLS).
2. Do not use the NEXCLUDE or OEXCLUDE process statement if the Y2DTONLY process statement has been specified.

Compare Types: FILE (ROWS option only) and LINE

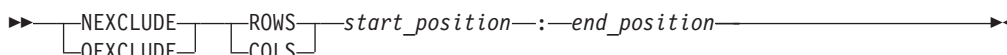

start_position

If ROWS operand used, the first row (record) to be excluded from the comparison. If COLS operand used, the first column to be excluded from the comparison.

end_position

If ROWS operand used, the last row (record) to be excluded from the comparison. If COLS operand used, the last column to be excluded from the comparison. (Must be separated from the *start_position* by a colon.)

Example

Description

NEXCLUDE ROWS 5:900

Excludes rows (records) 5 through 900 on the new file.

OEXCLUDE ROWS 1:900

Excludes rows (records) 1 through 900 on the old file.

OEXCLUDE COLS 100:199

Excludes columns 100 through 199 on the old file.

Focus on data

There are two Focus on Data process statements:

NFOCUS

Focus applies to the new file

OFOCUS

Focus applies to the old file

These two statements select (or “focus on”) rows or columns of data to be compared. In other words, only these rows or columns are considered when performing the comparison (or search) process and all other rows or columns are ignored. Up to 254 “focus” statements can be entered for each file.

Note:

1. NFOCUS and OFOCUS statements are mutually exclusive to NEXCLUDE and OEXCLUDE statements if using the same operand keyword (ROWS or COLS).
2. Do not use the NFOCUS or OFOCUS process statement if the Y2DTONLY process statement has been specified.

Compare Types: FILE (ROWS option only) and LINE

►►

NFOCUS	ROWS
OFOCUS	COLS

start_position—:—*end_position*—►►

start_position

If ROWS operand used, the first row (record) to be selected for the comparison. If COLS operand used, the first column to be selected for the comparison.

end_position

If ROWS operand used, the last row (record) to be selected for the comparison. If COLS operand used, the last column to be selected for the comparison. (Must be separated from the *start_position* by a colon.)

Example**Description**

NFOCUS ROWS 28:90

Selects rows (records) 28 through 90 on the new file.

OFOCUS ROWS 150:165

Selects rows (records) 150 through 165 on the old file.

OFOCUS COLS 10:18

Selects columns 10 through 18 on the old file.

Line count

The LNCT process statement specifies the number of lines per page in the listing file.

Compare Types: FILE, LINE, WORD, BYTE, and Search

►►—LNCT—*number*—►►

number

A decimal number between 15 and 999999.

Example**Description**

LNCT 55

Lists up to 55 lines per page.

List columns

The LSTCOLM process statement selects a range of columns to be listed in the output. This statement overrides the defaults that SuperC generates. Column selections must be contiguous and can be no wider than the output listing line allocated (55/80/106/176).

Compare Types: LINE and Search

▶▶—LSTCOLM—*start_column*—:—*last_start_column*—▶▶

start_column

The starting column to be listed.

last_start_column

The ending column to be listed. (Must be separated from the *start_column* by a colon.)

Example

Description

LSTCOLM 275:355

Lists columns 275 through 355 in the output.

List previous-search-following value

The LPSFV process statement specifies the number of lines preceding and following the search line found to be listed. The default value is 6.

Compare Type: Search

▶▶—LPSFV—*number*—▶▶

number

A decimal number between 1 and 50.

Example

Description

LPSFV 2

Lists up to 2 lines before and after the line found.

Revision code reference

The REVREF process statement identifies the revision type (BookMaster or SCRIPT/VS) and level-ID for delimiting UPDREV and UPDREV2 output changes. The revision delimiter may, alternatively, be specified or indicated by using a SCRIPT/VS .rc definition statement as the first line of the *new* input file.

If either the UPDREV or UPDREV2 process option is specified and no REVREF process statement is in the statements file, or the first *new* file source line is not a .rc script definition statement, SuperC defaults the revision definition to a SCRIPT/VS specification of .rc 1 |.

Note: BookMaster requires the REFID value to be defined with a :revision tag. Do not forget the "RUN=YES" attribute if you want your document to have the change-bar inserted in the processed document.

Compare Types: LINE and WORD

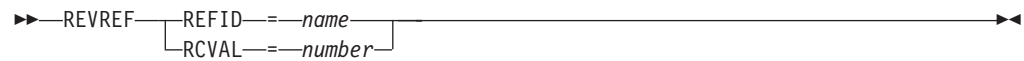
**REFID=*name***

Name of the revision identifier for the BookMaster :rev/:erev. tags.

RCVAL=*number*

Numeric revision code for SCRIPT/VS revision tags.

Example**Description****REVREF REFID=ABC**

BookMaster example :rev refid=ABC. and :erev refid=ABC. tags.

REVREF RCVAL=5

SCRIPT/VS example .rc 5 on/off delimiters.

Search strings in the input file

There are two process options to search for strings in the input file:

SRCHFOR

Search a text string in the input file

SRCHFORC

Search a text string continuation

These statements search for a specified string in the input Search file. The string may be further qualified as a word, prefix, or suffix, and where it must be positioned on the line.

SRCHFORC is the continuation of the immediately preceding SRCHFOR or SRCHFORC process statement. In the case of a SRCHFOR/SRCHFORC group, all the specified strings must occur on the same line for the search to be successful.

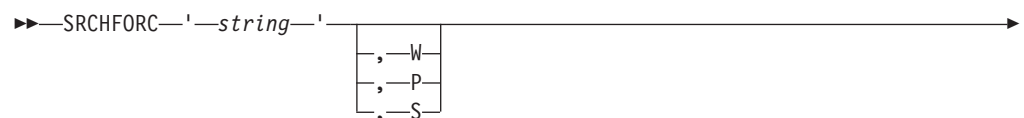
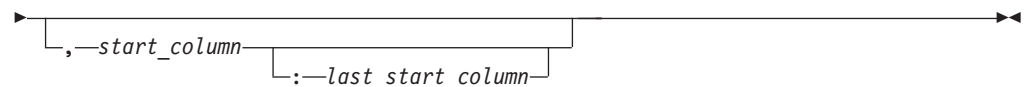
Compare Type: Search

Search strings in the input file

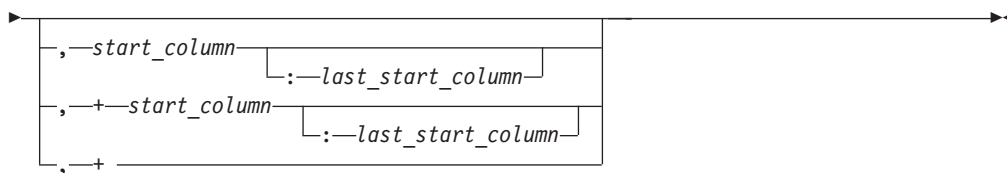

string The character or hexadecimal string to be searched for (enclosed by apostrophes). Use two consecutive apostrophes (") for one apostrophe within the search string.

W Word. String must appear as a separate *word*. That is, be delimited by one or more spaces or special characters.

P Prefix. String must appear as the first part of some other text.

S Suffix. String must appear as the last part of some other text.

start_column

The column in which the string must start for the search to be successful. (If a *last_start_column* is also specified, see description for that operand.)

last_start_column

The "latest" column in which the string can start for the search to be successful. (Must be separated from the *start_column* by a colon.)

+start_column

The relative column (starting from the column where the string for the previous SRCHFOR/SRCHFORC was found) in which the string must start for the search to be successful. (A corresponding *last_start_column* operand can be specified in a similar way to that for the *start_column*.)

+ The string specified can occur anywhere after the position of the previously found string for the search to be successful.

Example

Description

SRCHFOR 'ABC'

Searches for string "ABC"

SRCHFOR 'ABC',W

Searches for the word "ABC"

SRCHFOR X'4004'

Searches for the hexadecimal string X'4004'

SRCHFOR 'A'bc'

Searches for string "A'bc"

SRCHFOR 'ABC',5:10

Searches for string "ABC" starting in positions 5 to 10

SRCHFOR 'ABC',W,5

Searches for the word "ABC" starting in position 5

SRCHFOR 'ABC'SRCHFORC 'DEF'

Searches for strings "ABC" and "DEF" in any order in the same line.

SRCHFOR 'ABC'SRCHFORC 'DEF',+

Searches for the string "DEF" following the string "ABC"

SRCHFOR 'ABC'SRCHFORC 'DEF',W,+
 Searches for the word "DEF" following the string "ABC"

SRCHFOR 'ABC'SRCHFORC 'DEF',+5
 Searches for the string "DEF" in the 5th position after the string "ABC"

SRCHFOR 'ABC' SRCHFORC 'DEF',+5 SRCHFORC 'GKL'
 Searches for the string "DEF" in the 5th position after the string "ABC" with the string "GKL" also anywhere in the same line

Select PDS members

The SELECT process statement selects members from a PDS for comparison or for being searched. You can specify as many member names as fit on one line. If you need to select additional members, enter a new SELECT statement.

For comparisons, the new members are normally compared with old members that have the same names. Use the colon character (:) to compare members that are not named alike.

Any number of SELECT statements may be specified.

Compare Types: FILE, LINE, WORD, BYTE, and Search

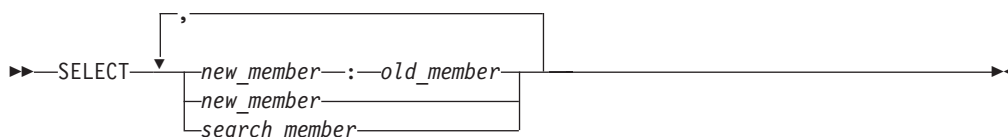

new_member

The name of a new PDS member that is to be compared to an old PDS member.

old_member

The name of an old PDS member that does not have a like-named member in the new PDS. This member name, if entered, must be separated from the *new_member* name by a colon (:).

If the *old_member* name is not used, SuperC attempts to compare the *new_member* to a like-named member of the old PDS.

search_member

The name of the PDS member that is to be searched.

Example

Description

SELECT NEW1,NEW2

For a comparison, compares member NEW1 from the *new* PDS with the member NEW1 from the *old* PDS and compares member NEW2 from the *new* PDS with the member NEW2 from the *old* PDS.

For a search, selects members NEW1 and NEW2 from the PDS to be searched.

SELECT NEW1:OLD1,MEMBER2

Compares member NEW1 from the *new* PDS with the member OLD1 from the *old* PDS and compares member MEMBER2 from the *new* PDS with the member MEMBER2 from the *old* PDS.

Statements file listing control

The SLIST process statement turns the printing of process statements in the output listing on and off.

The initial setting of this control is ON.

Compare Types: FILE, LINE, WORD, BYTE, and Search

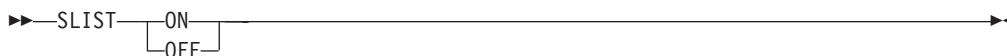

ON Causes the lines in the process statements file following the SLIST statement to be listed in the output listing.

OFF Causes the lines in the process statements file following the SLIST statement to be suppressed in the output listing.

Example Description

SLIST OFF
Do not list following process statements.

SLIST ON
List following process statements.

Title alternative listing

There are two process statements that let you provide an alternative title:

NTITLE
New (or search) listing file title identification

OTITLE
Old listing file title identification

These statements allow an alternative file identification to be used in the output listing (instead of the default identifiers "New File ID" and "Old File ID").

Compare Types: FILE, LINE, WORD, BYTE, and Search (NTITLE only)

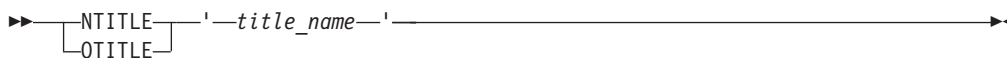

title_name
The alternative title to be used on the output listing to identify either the "new" file (NTITLE) or the "old" file (OTITLE). The title name must be in apostrophes and may be up to 54 characters in length. Use two consecutive apostrophes for one apostrophe within the title name.

Example Description

NTITLE 'New Title'
Change title heading for new (or search) file to "NEW TITLE"

OTITLE 'Old Title'
Change title heading for old file to "OLD TITLE"

Work size

The WORKSIZE process statement allows the maximum size of the comparison set to be adjusted for comparing large files.

If WORKSIZE exceeds 99999, then the SuperC LINE comparison DELTA listing type may result in wider columns for LEN N-LN# and O-LN#. Typically, these columns contain 5-digit values. However, when WORKSIZE exceeds 5 digits, and providing the standard record length of the listing is not affected, the columns are extended to contain 7-digit values. If the length of the input source lines in the listing are such that 7-digit values cannot fit, the report outputs 5-digit values by default, and only reports 7-digit values when significant characters are otherwise lost.

Compare Type: FILE, LINE, WORD, BYTE. It is ignored if specified on a SEARCH.



max_size

The maximum number of units for comparison. Maximum value is 9999999.

Year aging

There are two process statements for year aging:

NY2AGE

Aging applies to the new file

OY2AGE

Aging applies to the old file

These statements age all the defined dates in either the new or old file. That is, the number of years specified is added to the “year” portion of each defined date in the file concerned.

Note: Dates are *defined* by the Date Definition process statements NY2C, NY2Z, NY2D, NY2P, OY2C, OY2Z, OY2D, and OY2P; see “Date definitions” on page 492.

Compare Type: LINE

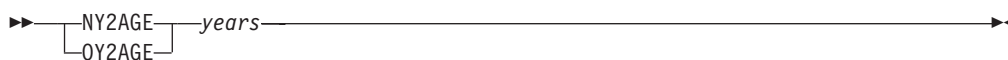

years A number (0 to 999) indicating the number of years by which all defined dates in the file are to be aged.

Example

Description

OY2AGE 28

Ages all defined dates in the “old” file by 28 years before being compared. The listing shows the original date. For example, a defined date in the “old” file with a value equating to March 1, 1997, is aged to March 1, 2025 before being compared to its equivalent in the “new” file.

Date definitions

There are eight process statements that set date definitions:

- NY2C New file, date in character format
- NY2Z New file, date in zoned decimal format
- NY2D New file, date in unsigned packed decimal format
- NY2P New file, date in packed decimal format
- OY2C Old file, date in character format
- OY2Z Old file, date in zoned decimal format
- OY2D Old file, date in unsigned packed decimal format
- OY2P Old file, date in packed decimal format

Note:

1. If any Date Definition process statements are used, also use a Y2PAST process statement, so that the “century” portion of the date can be determined where necessary. (If a Y2PAST process statement is not present, a default fixed window based on the current year is used.)
2. For a description of each date format (character, zone, decimal, and packed), see “Date formats (keyword suffixes: C, Z, D, P)” on page 494.
3. If any Date Definition process statements are used, an *information line* is generated on the listing output (see Figure 257 on page 511).
4. Do not use any Date Definition process statements if using the COLHEAD process statement.

Defines the location and format of a date field on the input file. Up to 254 date definition statements can be entered for each file. The matching of the new to the old dates is performed according to the sequence that the statements are entered. That is, the first defined *old* date is matched to the first defined *new* date.

If the number of date definition statements for one file differ from the number of date definition statements for the other file, the location and format details for the “missing” date definition statements are assumed to be the same as their counterpart date definition statements for the other file.

Compare Type: LINE

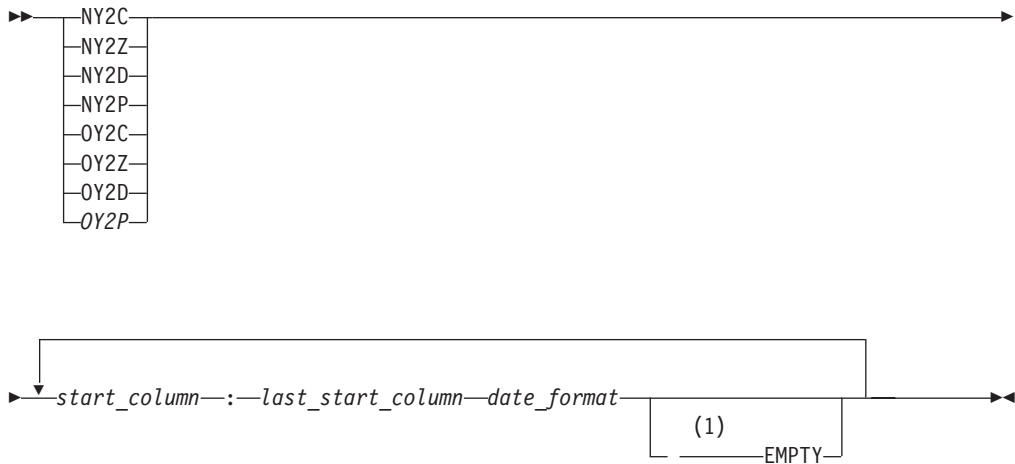

Notes:

- 1 The EMPTY keyword, when used, must be preceded by a space

start_column

The first position of the date in the input file.

last_start_column

The last position of the date in the input file. (Must be separated from the *start_column* by a colon.)

date_format

A mask representing the format of the date.

For a Julian date, the mask must be either YYDDD or YYYYDDD.

For date formats other than Julian, the mask must contain 2 "D"s (representing the day part of the date field), 2 "M"s (representing the month), and either 2 or 4 "Y"s (representing the year) or, if the date contains a year only, it must contain either 2 or 4 "Y"s.

If the date is character, there may also be a separator between the different parts. In this case, you can represent the position of the separators by one of the following characters:

- S (indicates that this position within the date is not used in comparison)
- .
- / (forward slash, used in comparison)
- :

Note: The length of the *date_format* mask must correspond to the length of the date in the input file as indicated by the values of *start_column* and *last_start_column*.

EMPTY

This keyword is optional. If it is entered, the defined date field is checked for containing zeros, spaces, low-values, or high-values before commencing the comparison process. If any of these values are found, the date is not converted according to the Y2PAST criteria but instead is converted to an extended format with the initial value. For example, a date defined by the process statement OY2C YYMMDD which contains all zeros is compared as "YYYYMMDD" with a value of zeros.

Example**Description****NY2C 1:8 MMDDYYYY 9:16 MMDDYYYY 21:28 YYYYMMDD**

The new file has dates in character format in columns 1 to 8, 9 to 16 and 21 to 28.

OY2P 5:8 YYMMDD 9:12 YYMMDD

The old file has dates in packed decimal format in columns 5 to 8 and 9 to 12.

OY2P 101:104 MMDDYY

The old file has a date in packed decimal format in columns 101 to 104,

NY2Z 101:108 YYYYMMDD

The new file has a date in zoned decimal format in columns 101 to 108.

NY2C 101:110 YYYY.MM.DD

The new file has a date in character format (with separators) in columns 101 to 110.

OY2C 93:98 DMMYY EMPTY

The old file has a date in character format in columns 93 to 98. If the date field contains zeros, spaces, low-values, or high-values, the date in the old

Date definitions

file is converted before being compared to an extended format (DDMMYYYY) with a value of all zeros, spaces, low-values, or high-values.

Date formats (keyword suffixes: C, Z, D, P)

C Character date data.

Examples:

'96' is represented as hexadecimal X'F9F6'

If using a MMDDYY format, March 21, 1996 is represented as hexadecimal X'F0F3F2F1F9F6'

Z Zoned decimal date data. The date can be represented as follows:

X'xyxy' to X'xyxyxyxyxyxyxyxy'

y is hexadecimal 0 to 9 and represents a date digit. x is hexadecimal 0 to F and is ignored.

Examples:

'96' is represented as hexadecimal X'F9C6' or X'0906'

'03211996' is represented as hexadecimal X'F0F3F2F1F9F9C6' or X'0003020101090906'

P Packed decimal date data. The date can be represented as follows:

X'zyyx' to X'zyyyyyyyx'

y is hexadecimal 0 to 9 and represents a date digit. x is hexadecimal A to F and is ignored. The z part is normally zero but is not ignored.

Examples:

'96' is represented as hexadecimal X'z96F' or X'z96C'

'1996' is represented as hexadecimal X'z1996C'

'03211996' is represented as hexadecimal X'z03211996x' (the x part is ignored).

'96203' (a Julian date) is represented as hexadecimal X'96203C'

D Unsigned packed decimal date data. The date can be represented as follows:

'yy' to 'yyyyyyyy'

y is hexadecimal 0 to 9 and represents a date digit.

Examples:

'96' is represented as hexadecimal X'96'

'03211996' is represented as hexadecimal X'03211996'

Global date

The Y2PAST process statement specifies a 100-year period (used for determining the century-part of a date when only a 2-digit year has been specified). The Y2PAST process statement uses either a fixed or sliding window.

Note: Always use the Y2PAST process statement if one of the Date Definition process statements (NY2C, NY2Z, NY2D, NY2P, OY2C, OY2Z, OY2D, OY2P) has also been used.

Compare Type: LINE



fixed A 4-digit number indicating a fixed window.

sliding

A 1-digit or 2-digit number indicating a sliding window.

Example

Description

Y2PAST 1986

A fixed window specifying a 100-year period from 1986 to 2085.

Y2PAST 70

A sliding window specifying (based on the current year being 2001) a 100-year period from 1931 (70 years in the past) to 2030.

Y2PAST 5

A sliding window specifying (based on the current year being 2001) a 100-year period from 1996 (5 years in the past) to 2095.

Reasons for differing comparison results

When comparing two sets of input date, it is possible that different compare types (FILE, LINE, WORD, and BYTE) gives slightly different results.

In order for SuperC to detect only the types of differences that are of interest to you, make sure that you are using the most appropriate compare type and, if necessary, the appropriate process options and process statements to select only the data that you actually want compared.

Here are some of the reasons why different compare types can produce different results:

- FILE and BYTE comparisons inspect the complete file (every byte) for differences. LINE and WORD comparisons use designated columns that are either specified by you or are within the default range of columns assigned by SuperC.
For example, a FILE comparison of a file with fixed-length records of eighty bytes compares all columns (that is, all bytes), whereas a LINE comparison of the same file compares columns 1 to 72 (the default). Since the sequence number columns in the file are ignored in the LINE compare, the final results can be different. In this case, for consistent results, specify the LINE compare type and the NOSEQ process option.
- LINE comparisons “pad” the shorter records with spaces when comparing files with different record lengths. However, BYTE comparisons only “recognize” spaces when they are already present in the input file.
- For files with input line lengths ≤ 256 , a LINE comparison is performed after padding the lines to the longest line length. Consequently two lines, originally of unequal length, compare equally only if the spaces at the end of the longer line coincide with the shorter line's space padding.
- For files with input line lengths > 256 , a LINE comparison is performed on the lines without space padding. As a result, lines of unequal length are always a mismatch.
- Different compare types have different sensitivity to being resynchronized. Synchronization for a LINE comparison begins at the beginning of a line and ends at the end of a line. Synchronization for a WORD comparison begins

Reasons for differing comparison results

anywhere on a line on any word boundary and ends at the end of a word. Synchronization for a BYTE comparison extends only one byte anywhere on a line.

- LINE comparisons detect lines that have been reformatted. However, reformatted lines have no effect on WORD comparisons as spaces and blank lines are ignored.
- Results may differ depending on which input file is specified as the “new” file and which is specified as the “old” file. The matching algorithm is sensitive to the largest matched *set* it finds between files. There may be occasions where more than one *set* of matched data meets this criteria. The rules for deciding which *set* to choose among the equals depends upon the contents of each file and which file was nominated as the “new” file.

Return codes

SuperC displays the completion message at the top of the Primary Comparison Menu or at the top of the Primary Search Menu. The message is an interpretation of the following return codes.

Table 26. SuperC return codes

Code	Meaning
0	Normal completion. Comparison The input files are the same. No differences found. Search No matches found in the input file.
1	Normal completion. Comparison Differences were found in the input files. Search Matches found in the input file.
4	WARNING. Erroneous input was detected. Files were compared but results may not be as expected. Check listing for more information.
6	WARNING. <i>Old</i> file did not contain proper sequence numbers, or the sequence number intervals were not sufficiently large to contain insert activity (UPDCMS8 and UPDMVS8).
8	ERROR. Error on <i>old</i> input file. Files were NOT compared. Check listing for more details.
16	ERROR. Error on <i>new</i> or search source file. The operation was NOT performed. Check listing for more details.
20	ERROR. I/O error writing to update file, FILEDEF missing, or APNDUPD process option cancelled because of inconsistent file attributes.
24	ERROR. I/O error writing to the output listing file.
25	ERROR. The <i>old</i> output file attributes are not consistent with the new listing requirements. The APNDLST process option can not be accepted and the operation is immediately terminated.
26	ERROR. The output file caused a “disk full” condition. The output listing is incomplete.
27	ERROR. The output file is a “read-only” disk. All I/O operations to the disk is suppressed.
28	ERROR. No data was compared because of invalid file names, no commonly named members of both input file groups, or one or both input files were empty.

Table 26. SuperC return codes (continued)

Code	Meaning
32	ERROR. Insufficient storage was available for SuperC to execute. Refer to output listing for more details.
36	ERROR. z/VSE file would not open.
40	ERROR. z/VSE label information not available.
48	ERROR. z/VSE Librarian member not found.
52	ERROR. z/VSE VSAM Showcat failed.
56	ERROR. z/VSE device type not supported.
60	ERROR. Wrong length record read on tape input.

SuperC and search-for technical overview

This topic describes these SuperC and Search-For processes:

- How SuperC and Search-For filter input file lines
- How SuperC matches input file lines
- How SuperC partitions and processes large files
- Why SuperC compare types may produce different results
- How to directly invoke the SuperC and Search-For programs.

How SuperC and search-for filter input file lines

The SuperC and Search-For utilities apply process options and process statements to the input file or files in a specific order. Figure 251 on page 498 shows schematically the effects, in the order that they occur, of the various “filtering” process options and process statements, on the compare and Search-For input lines. The options and statements nearer the top affect the input line before options or statements nearer the bottom.

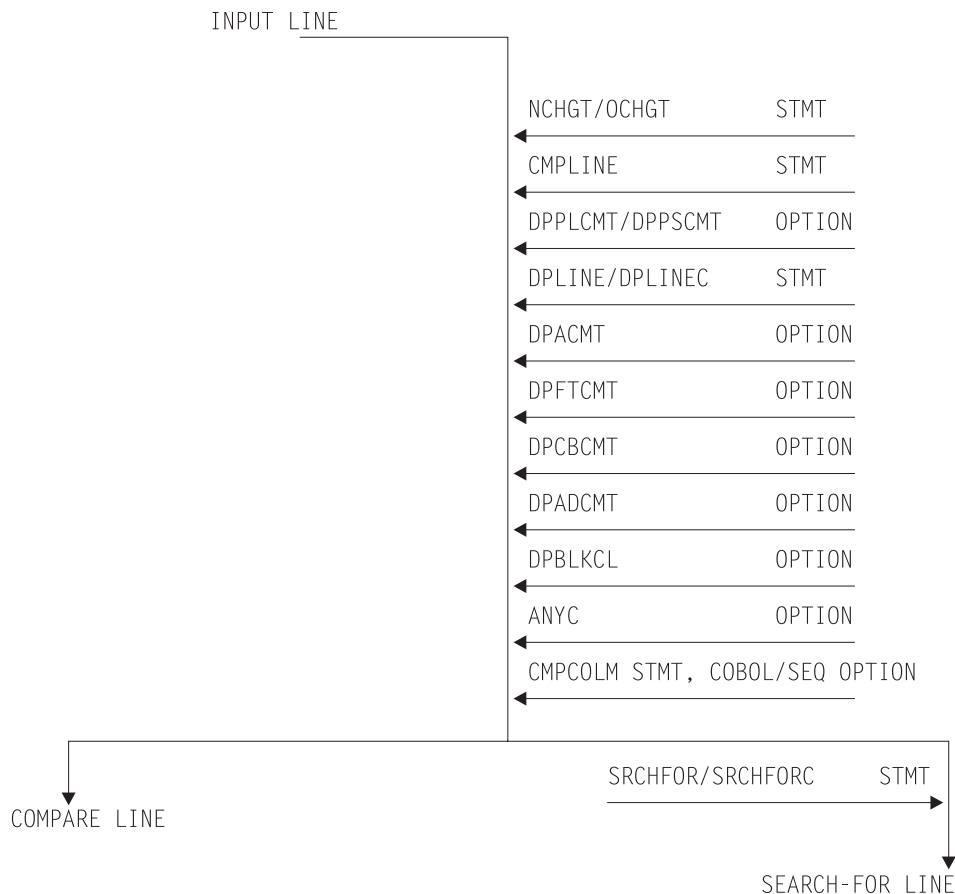

- Both options and statements “filter” the input lines.
- “Filtered” input lines are passed to either compare or Search-For processing.

Figure 251. Priority for filtering input lines

How SuperC matches input files

When SuperC compares files, it determines matching and missing lines or words based only on the data content of the input files. It does not use any synchronization data, such as column or sequence numbers, to find matching file sections. It does not use the common “start at the top”, then look-ahead or look-back method to determine large sections of matching data. Neither does it sort the data before comparing.

SuperC is unique in that, except for files that are identical, it does not determine matching sections until it has completely read both files. Missing data units are units that are out of sequence, as opposed to units that have been deleted from a file. During a comparison, SuperC finds all matches, locates the largest set of matching data units, and recursively allows this compare set to divide the file into additional partitioned subsections. All new subsections are processed for corresponding matches. The subprocess ends when no more matches can be found within corresponding *new* and *old* file partitioned subsections. Sections classified as inserted or deleted are corresponding areas for which SuperC could not find a match.

Figure 252 shows an example of a comparison of two files that are identified as having lines represented by A, B, C, ... F. The SuperC algorithm attempts to find the best match set from the input lines. Notice how the match set requires consideration of duplicate lines.

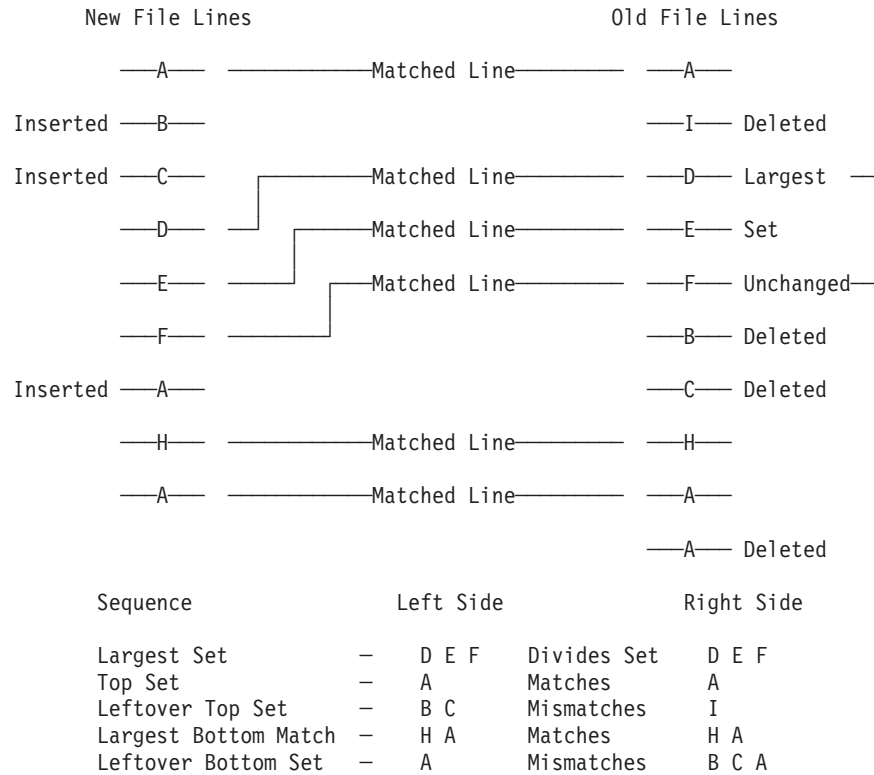

Note: The inserted &odq.A&cdq. on the lower left cannot connect with the deleted &odq.A&cdq. on the bottom right due to H A barrier.

Figure 252. Find match example

How SuperC corrects false matches

Occasionally, SuperC reports that it has detected a false line or word match and has corrected the results in the listing and summary report. Any affected matched pair has been reclassified as an insert/delete pair. Any resulting error might be in the masking of potential matches that would be overlooked due to the early false match coupling. That is an equivalent yet undiscovered match may be overlooked due to the premature false matching. The condition should be of minor importance since it happens so rarely and the masking effect has a low probability of affecting the final results.

An equally important SuperC concern would be whether it finds the best match set and whether it finds all matches. Unfortunately, the match-finding algorithm is not perfect. Ignoring the false match masking problem, and the large number of duplicate source lines obscuring the match set possibilities, occasional matches can be overlooked.

Many Artificial Intelligence (AI) computer programs, like SuperC, only approximate the human intellect that can sometimes make a better match set selection. Furthermore, these same computer programs are designed for speed and efficiency. They necessarily make certain simplifying assumptions and contain additional operational weaknesses. SuperC, however, does not fail to correctly classify mismatches and does not incorrectly classify a mismatch as a match.

How SuperC partitions and processes large files

In SuperC, there is no limit on the size of files processed in terms of lines, words or bytes. Yet it had an internal methodology based upon a maximum field size for each work area storage structure (for example, array size and precision of variables). A method was developed to do the overall comparison process by breaking very large files into smaller comparison partitions and combining the intermediate results into one overall result. The process had to be done carefully so that it did not look as if the file partitioning was determined after some arbitrary limit was reached. That could affect the results on either side of the break point. The partitioning had to be done heuristically based upon the comparison results from the previously inspected intermediate process.

A fixed partitioning size of 32K lines/words/bytes was selected that was based on some test studies. The compare processes up to this limit and iteratively adjusts the intermediate ending break point of the pass by an adaptive method. Continuation from the adjusted end point is the basis for the next pass. That end point might even be adjusted to some previous records that had already been processed. The objective is to achieve the next best compare set for future unprocessed records.

The overall process ends when both files reach the End-of-File during a pass. The results from the intermediate passes are combined into one user end result. Most large compares are never suspected to have been partitioned and recombined.

The unlimited file size solution may appear, at first, unnecessary for Line compare using a virtual address space that is nearly unlimited. Yet there often has to be some limit—even if it is a high value. Programs need to store data with predetermined precision limits and programs work better with limits that are reasonable. Word compare and Byte compare eventually needed a partitioning limit for the compare as the number of words and bytes become large even for small file sizes.

Because of this partitioning process, comparisons of large files may take a long time.

Comparing and searching alias members

When you compare or search all of the members of two partitioned data sets using the command `S *` (to select all entries in the directory) on the member list, any members that have alias entries are processed once for the real name, and once for each alias entry. For compare, unpaired aliases appear in the same list as unpaired real members as "NON-PAIRED NEW FILE MEMBERS" or "NON-PAIRED OLD FILE MEMBERS".

When you compare or search entire data sets by using an asterisk (*) for a member name pattern, only real members, not aliases, are processed. For compare, all directory entries (for both real members and aliases) are analyzed. Messages appear at the end of the SuperC output listing that give information about unpaired alias entries for paired real members as follows:

```
"NEW" PAIRED MEMBERS WITH "NEW" ALIAS MEMBERS NOT PAIRED FOLLOW:
    MEMBER1/ALIAS1  MEMBER1/ALIAS2  MEMBER2/ALIAS1 ...
    or
"OLD" PAIRED MEMBERS WITH "OLD" ALIAS MEMBERS NOT PAIRED FOLLOW:
    MEMBER1/ALIAS1  MEMBER1/ALIAS2  MEMBER2/ALIAS1 ...
```

followed by a listing of the unpaired member/alias entries.

Note:

1. Consider the ALLMEMS process option if you want to compare all directory entries, including aliases, but do not want to select them from a member list. This is useful for batch comparisons of entire load modules.
2. This listing section is not created for non-load module data sets containing alias entries.

Comparing load modules

SuperC compare of load module data might show unexpected differences. This is because SuperC compares all the data in the load module as it is found on DASD, and does not attempt to decode which portions are executable, and which might contain uninitialized storage.

The complex data format on DASD is dependent on the load module data set block size, and defined storage definitions which are controlled by the linkage editor. The size stored by the linkage editor in the PDS directory may differ from the DASD data byte count reported by SuperC and Browse depending on the characteristics of the load module.

If load modules are exact copies of each other, SuperC should find no differences. If load modules have been link-edited from the same object but with different block sizes, SuperC will probably report they are different.

Because of the relative DASD addresses (TTRs) in load modules, the recommended procedure for comparing load modules which have not been reblocked is to use the AMBLIST utility with LISTLOAD OUTPUT=MODLIST against both load modules, then use SuperC to compare the two AMBLIST outputs. There is no easy way to compare load modules with different internal record sizes such as occurs when COPYMOD or LINKEDIT processes them.

Comparing CSECTs

SuperC compare of PDS Load Module Csects (using the LMCSFC Process Option) can return unexpected differences. SuperC looks at the length of the Csect from the control record immediately preceding the Csect data record in the load module. This physical data length can differ from the logical Csect data length in the load module header that the AMBLIST utility uses to report the length of the Csect.

SuperC always compares all of the physical data in each Csect. You can use SuperC Byte compare to examine the Csect data content in detail.

Note: This option is only valid for PDS load modules.

How to directly invoke SuperC and search-for

You can run the SuperC and Search-For programs directly without using the ISPF-provided utilities (Options 3.12, 3.13, 3.14, or 3.15). This requires an installation (or system programmer) to customize a CLIST (for interactive usage) or a PROCLIB procedure (for batch execution of a catalog procedure). Although these methods are not warranted by the ISPF product, a sample CLIST and a sample PROCLIB procedure are distributed as an aid in the SAMPLIB data set as members ISRSCLST and ISRSPROC.

The sample CLIST allows a TSO user to enter a line command to communicate the operational parameters directly to the SuperC program without displaying the ISPF panels. The sample CLIST will request entry of a search pattern or string. A sample SuperC call as entered on the terminal might look like:

SuperC/search-for technical overview

```
superc newfile(.newdata.file) oldfile(ludlow.olddata.file)
```

or

```
exec clist(superc) 'new(.newdata.file) old(ludlow.olddata.file)'
```

where *superc* is the command and *newfile* and *oldfile* are the keywords for the input files.

The SuperC load module may be supported using a private library or a concatenated system library. The installation is responsible for making the corresponding changes to the sample CLIST.

The sample CLIST uses this format:

```
SUPERC NEW(dsn) OLD(dsn) {keyword(parameter) .... }
```

Note: Avoid using uninitialized data sets (that is, empty sequential data sets with no end-of-file marker) in the concatenation of data sets to be compared. Including these data sets in the search can lead to unpredictable results.

The keywords and parameters are:

CTYPE

Specifies the compare type. The parameter can be one of the SuperC compare types (File, Line, Word, or Byte). To call the Search-For program, use CTYPE(SRCH).

LISTING

Specifies the listing type. The parameter can be one of the SuperC listing types.

OUTDD

Specifies the name of the Listing Data Set. Use a fully qualified *dsn* or use a period (.) to precede the *dsn* with SYSPREF. The use of the period is a compromise because fully qualified names enclosed in quotes are difficult to pass in CLISTS.

BROWSE

Specifies the auto display program.

SYSIN

Specifies whether SuperC prompts the user for the process statements or uses a statements data set. The parameters can be PROMPT or the name of the statements data set.

DELDD

Specifies the name of the update data set.

PROCESS

Specifies the process options. The parameter can be a SuperC or Search-For process option. Not all options are allowed with each compare type (for example, GWCBL is valid only with Line and Word compare) or with other options (for example, you cannot use SEQ with COBOL). See "Process options" on page 461 for more information.

Examples

This example shows a SuperC compare JCL sequence:

```
//COMPARE EXEC PGM=ISRSUPC,PARM=('LINECMP,CHNGL,UPDCNTL')
//STEPLIB DD DSN=ISPF.LOAD,DISP=SHR
//NEWDD DD DSN=DLUDLOW.PDS(TEST1),DISP=SHR
//OLDDD DD DSN=DLUDLOW.PDS(TEST2),DISP=SHR
//OUTDD DD SYSOUT=A
//DELDD DD DSN=DLUDLOW.UCTL1,DISP=OLD
//SYSIN DD *
        CMPCOLM 2:72
/*
```

The sequence allows the SuperC program to compare two input data sets and generates a line compare CHANGE type listing to the spool output queue and a separate UPDCNTL update control data set output using source columns 2 through 72.

A catalog procedure is a set of “canned” JCL statements that you can invoke as an extension of your own JCL. Here is a simplified JCL sequence:

The keywords NEWFILE, OLDFILE, and LISTING cause symbolic substitution

```
//SUPER JOB
// EXEC SUPERC,
// NEWFILE='DLUDLOW.GROUP.DATA1',
// OLDFILE='MFRAME.GROUP.DATA2',
// LISTING=DELTA
```

before the job submittal.

Note: A sample catalog procedure is contained in the SAMPLIB member ISRSPROC.

A simplified Search-For JCL sequence follows. The SRCHFOR process statement used in the search is part of the JCL instead of a separate SYSIN data set. Concatenated data sets are also shown as part of the JCL.

```
// JOB
//SEARCH EXEC PGM=ISRSUPC,PARM=('SRCHCMP,ANYC')
//STEPLIB DD DSN=ISPF330.LOAD,DISP=SHR
//NEWDD DD DSN=USERID.PDS,DISP=SHR
// DD DSN=USERID.PDS2,DISP=SHR
//OUTDD DD SYSOUT=*
//SYSIN DD *
SRCHFOR 'NEEDLE',W,10:20
/*
//
```

A very simplified Search-For sample CLIST follows:

```
PROC 0
FREE FI(NEWDD,SYSIN,OUTDD,SYSIN2)
ALLOC FI(NEWDD) DA('USERID.PDS(TEST1)') REUSE SHR
ALLOC FI(SYSIN) DA('USERID.SYSIN.DATA(STMTS)') REUSE SHR
DELETE 'USERID.USER.PDS'
ALLOC FI(OUTDD) DA('USERID.USER.LIST') SPACE(10,20) RECFM(F B) +
        REUSE TRACKS RELEASE
CALL 'USERID.ISPF.LOAD(ISRSUPC)' 'SRCHCMP,ANYC'
/*****
/* SIMPLE CLIST WITH MINIMUM STATEMENTS. */
/* "USERID.SYSIN.DATA(STMTS)" MUST CONTAIN SRCH STMTS.*/
*****/
```

SuperC/search-for technical overview

Appendix B. Understanding the listings

SuperC allows you to produce a range of listings (reports) which provide detailed information about the results of your comparison or search.

General listing format

The format and content of each type of listing depends on:

- Whether you are using the SuperC Comparison or the SuperC Search
- The *listing type* used

Note: The NOLIST listing type suppresses the generation of any listing output or listing file.

- Whether you are comparing (or searching) a *single* file or a *file group*
- The *compare type* used (in the case of the SuperC Comparison)
- The *process options* used
- The *process statements* used

Note: Dates in the heading lines on the sample listing output in this document appear in the format MM/DD/YYYY. The dates in the heading lines appear in the format YYYY/MM/DD.

How to view the listing output

The listing output is always written to a *listing file* (unless the NOLIST listing type is used), from which you can print the listings.

The following pages contain:

- A description of the general format of the *comparison listing* (see “The comparison listing”), followed by examples of various listings produced by the SuperC Comparison.
- A description of the general format of the *search listing* (see “The search listing” on page 517), followed by examples of various listings produced by the SuperC Search.

The comparison listing

SuperC comparison listings consist of four basic parts (although not all parts are present for all types of listing output produced):

- Page Headings (see “Page headings”)
- Listing Output Section (see page “Listing output section” on page 506)
- Member Summary Listing (see “Member summary section” on page 508)
- Overall Summary Section (see “Overall summary section” on page 510)

Page headings

SuperC generates a page heading at the top of each page. The heading consists of two lines of information.

Understanding the listings

```
1  ASMFUPC - MVS FILE/LINE/WORD/BYTE/SFOR COMPARE UTILITY- V1R6M0 (07/11/2008) 07/11/2008 12.31 PAGE 1
NEW: NEW TEST1 A OLD: OLD TEST1 A
```

Figure 253. Example of page heading lines for the comparison listing

Figure 253 shows typical page heading lines. The first line contains:

- Printer control page eject character (“1” in column one. Not present when the NOPRTCC process option is specified)
- “Platform-identifier”. This shows “MVS”.
- Program identification title including version and the version date: V1R6M0 (07/11/2008)
- The date and time of the compare
- The page number

Note: The program version and program date are important when reporting suspected SuperC problems.

The second heading line identifies the *new* and *old* files. Normally this line shows the file IDs of the *new* and *old* files. However, if the NTITLE and OTITLE process statements have been specified then the corresponding alternative file titles are shown instead of the file IDs.

Listing output section

The listing output section shows where and what the changes are. Figure 254 is an example of a Listing Output Section for a LINE comparison with a listing type of DELTA.

```
1 LISTING OUTPUT SECTION (LINE COMPARE)
2 ID SOURCE LINES |...| TYPE LEN N-LN# O-LN#
3 ----+----1----+----2----+ |...| +-----8
4 I - 970521 |...| RPL= 1 00001 00001
5 INFO Date cols 11:15 packed 2 |...|
6 D - 970522
5 INFO Date cols 11:14 packed 1 |...|
```

Figure 254. Example of the listing output section of the comparison listing

- 1** Section title line. It tells you that this is a LINE comparison. Possible compare types are BYTE, FILE, LINE, and WORD.
- 2** Column header line.
 - ID** A two-column prefix code that identifies the status of the line. See “Listing prefix codes” on page 507.
 - SOURCE LINES** The actual text or data from the source files. Under this heading, the actual data from the files is listed.
 - TYPE** Further breakdown of the ID field. See “Type of difference codes” on page 508 for information about TYPE codes.
 - LEN** The “length” or number of consecutive lines of the selected type.

N-LN#

Indicates the relative record (line) number of this line (or where it is to be inserted) in the *new* source file. Numbers are in decimal.

O-LN#

Indicates the relative record (line) number of this line (or where it was deleted from) in the *old* source file. Numbers are in decimal.

3 The scale of the column positions of the input source lines.

4 An inserted (I) line. The RPL in TYPE indicates that it is a replacement line. This replacement involves the line 00001 in both files.

Note: Occasionally, you may see some “unusual” characters on the inserted (I) and deleted (D) lines. These characters represent data that is in a non-character (and therefore not directly printable) format in the input record. Ignore them.

5 An information line that is generated on a comparison listing when a Date Definition process statement is used (see “Date definitions” on page 492) and when the preceding inserted (I) line or deleted (D) line contains a date. The information line shows you the content of the date field as it exists on the input file and the date as used in the comparison. For a full example, see Figure 257 on page 511.

6 A deleted (D) line.

Listing prefix codes

SuperC output lines are flagged with the following prefix codes listed under the ID column:

(space)

Match No prefix code means the data is the same in both files.

I *Insert* Data that is in the *new* file, but is missing⁵ from the sequence in the *old* file.

D *Delete* Data that is in the *old* file, but is missing⁵ from the sequence in the *new* file.

DR *Delete Replace* For BYTE compare type only. The bytes in the *old* file that were replaced by the bytes shown in the preceding insert (I) line.

RN *Reformat New* For LINE compare type only. A reformatted line in the *new* file. This line contains the same data as the *old* file line, but with different spacing.

RO *Reformat Old* For LINE compare type only. A line in the *old* file that is reformatted in the *new* file. This line is not shown if the DLREFM process option is used.

MC *Match Compose* For WORD compare type only. A line containing words that match. The line may also contain spaces to show the relationship between the matching words and any inserted or deleted words. Inserted and deleted words are shown in following insert compose (IC) and delete compose (DC) lines. See Figure 264 on page 517 for an example using a WORD compare type.

5. “Missing” data is data that is missing from the data sequence but may exist in some other part of the file.

Understanding the listings

- IC** *Insert Compose* For WORD compare type only. A line containing words from the *new* file that are not in the *old* file. This line normally follows a match compose (MC) line.
- DC** *Delete Compose* For WORD compare type only. A line containing words from the *old* file that are not in the *new* file. This line normally follows a match compose (MC) or insert compose (IC) line.
- IM** *Insert Moved* For comparison listings created using the FMVLNS (flag moved lines) process option. A line in the *new* file that also appears in the *old* file, but has been moved. If the line was reformatted, this is indicated by a flag to the right of the listing.
- DM** *Delete Moved* For comparison listings created using the FMVLNS (flag moved lines) process option. A line in the *old* file that also appears in the *new* file, but has been moved. If the line was reformatted, this is indicated by a flag to the right of the listing.
- I** *Change Bar* For comparison listings created using the GWCBL (generate WORD/LINE comparison change bar listing) process option. A change bar showing that words/lines were either inserted or deleted.

Type of difference codes

At the far right of some listings are headings that provide additional information about the numbers and types of differences SuperC has found. Headings you may see are:

MAT= Number of matched lines.

RFM= Number of reformatted lines.

RPL= Number of replaced lines.

INS= Number of lines that are in the *new* file, but missing in the *old* file.

DEL= Number of lines that are in the *old* file, but missing in the *new* file.

IMR= Number of lines in the *new* file that have been moved from where they were in the *old* file and reformatted. The listing shows a matching "DMR=" flag for a line in the *old* file.

DMR=
Number of lines in the *old* file that have been moved and reformatted in the *new* file. The listing shows a matching "IMR=" flag for a line in the *new* file.

IMV= Number of lines in the *new* file that have been moved from where they were in the *old* file. The listing shows a matching "DMV=" flag for a line in the *old* file.

DMV=
Number of lines in the *old* file that have been moved in the *new* file. The listing shows a matching "IMV=" flag for a line in the *new* file.

Member summary section

SuperC generates the member summary section when you specify either a file group comparison or use a macro library (MACLIB) or text library (TXTLIB) as input. The member summary section is really two sections with a page separator between them.

Figure 255 on page 509 shows an example of the two member summary sections for a FILE compare type.

The first section indicates which files were compared and whether they were found to be different or the same. In Figure 255, NEW TEST1 A was compared to OLD TEST1 A and NEW TEST2 A was compared to OLD TEST2 A. Both comparisons found differences. Following the member statistics are the group statistics. As this was a FILE comparison, the statistics are in terms of files and the number of bytes in each file.

Note: Different compare types produce slightly different results in the first section.

The second part of the member summary section shows all the members from both the *new* and *old* file groups which were not paired (and hence not compared). In Figure 255, only OLD TEST3 A from the *old* file group was not compared to any file from the *new* group.

1	MEMBER SUMMARY LISTING (FILE COMPARE)								
2	DIFF	SAME	FILE NAMES				N-BYTES	O-BYTES	
3	**	NEW	TEST1	A5	OLD	TEST1	A5	240	240
	**	NEW	TEST2	A5	OLD	TEST2	A5	240	240
4	-----							-----	-----
	GROUP TOTALS							480	480
5	2	TOTAL FILES PROCESSED AS A GROUP							
6	2	TOTAL FILES PROCESSED HAD CHANGES							
7	0	TOTAL FILES PROCESSED HAD NO CHANGES							
8	0	TOTAL NEW FILES NOT PAIRED							
9	1	TOTAL OLD FILES NOT PAIRED							
1 ASMFUPC - MVS FILE/LINE/WORD/BYTE/SFOR COMPARE UTILITY- V1R6M0									
NEW: NEW TEST* A OLD:									
MEMBER SUMMARY LISTING (FILE COMPARE)									
NON-PAIRED NEW GROUP FILES							NON-PAIRED OLD GR		
							10	OLD	TEST3 A5

Figure 255. Example of the member summary section of the comparison listing

- 1** Section Header. In this context, “member” can refer to either members of a MACLIB or TXTLIB, or members of a file group.
- 2** Header line. Consists of several column headers.
 - DIFF** Contains “**” when the *new* and *old* files differ.
 - SAME** Contains “**” when the *new* and *old* are the same.
 - FILE NAMES**
The file names or paired members of the file group or MACLIB/TXTLIB compared.
 - N-BYTES**
Number of bytes processed in the *new* member.
 - O-BYTES**
Number of bytes processed in the *old* member.
 - N-LINES**
(Not shown) Number of lines processed in the *new* member.

Understanding the listings

O-LINES

(Not shown) Number of lines processed in the *old* member.

N-HASH-SUM

(Not shown) SuperC generated a hash value for the *new* member.

O-HASH-SUM

(Not shown) SuperC generated a hash value for the *old* member.

Note: The hashsums of files can be used to compare two files that are not physically on the same system. If the hashsum of a file on system A is different from the hashsum of a file on system B, then the files can be said to be different. If the hashsum of the files are identical, there is a high probability that the files are the same. As secondary confirmation that the files are the same, compare the number of lines and number of bytes.

- 3** Group (file) file statistics.
- 4** Group totals header line.
- 5** Total number of files that were processed as a group.
- 6** Total number of files compared that had differences.
- 7** Total number of files compared that had no differences.
- 8** Total number of *new* files that were not paired (and therefore were not compared).
- 9** Total number of *old* files that were not paired (and therefore were not compared).
- 10** OLD TEST3 A5 was present in the *old* file group. It could not be paired with a similarly named file in the *new* file group and was not processed.

Overall summary section

The overall summary section gives the overall statistics of the comparison process. Figure 256 is a representative example of an overall summary section.

```
1          LINE COMPARE SUMMARY AND STATISTICS
2 2 NUMBER OF LINE MATCHES      8 1 TOTAL CHANGES (PAIRED+NONPAIR
3 0 REFORMATTED LINES          9 1 PAIRED CHANGES (REFM+PAIRED
4 1 NEW FILE LINE INSERTIONS   10 0 NON-PAIRED INSERTS
5 1 OLD FILE LINE DELETIONS    11 0 NON-PAIRED DELETES
6 3 NEW FILE LINES PROCESSED
7 3 OLD FILE LINES PROCESSED

12 LISTING-TYPE = OVSUM      13 COMPARE-COLUMNS =    1:72
14 LONGEST-LINE = 80
15 PROCESS OPTIONS USED: NONE
```

Figure 256. Example of the overall summary section of the comparison listing

Figure 256 shows the following information about the comparison:

- 1** The first word of the title tells you the type of comparison. The overall summary is provided for BYTE, FILE, LINE, and WORD compare types.
- 2** Of the 3 lines in each file, 2 from the *new* file matched 2 corresponding lines of the *old* file. These are called matching lines.

- 3** There are no reformatted lines.
- 4** There is 1 inserted line in the *new* file.
- 5** The *old* file contains 1 line that is missing from the *new* source file.
- 6** 3 lines from the *new* file were processed.
- 7** The *old* file also has a total of 3 lines.
- 8** The total number of changes is a summation of items **9**, **10**, and **11**. It is a convenient number that best represents the change activity of the two compared files.
- 9** The total number of reformat and paired changes. This represents a sum of items that may be considered to be a single change. That is, some changes are made in pairs and need only be counted as a single instance of a change.
- 10** There were no non-paired inserts. Non-paired inserts are changes to the *new* file that have no relationship to the *old* file (that is, no deletes from the *old* file occurred in the same area).
- 11** There were no non-paired deletes. Non-paired deletes are changes to the *old* file that have no relationship to the *new* file (that is, no inserts to the *new* file occurred in the same area).
- 12** The listing type is OVSUM. This is the listing type option selected for the comparison. Other options are: DELTA, CHNG, and LONG.
- 13** SuperC compared columns 1 through 72. This value provides a convenient reference for confirming if all the columns in the line have been compared or only some portion of the line.
- 14** The longest line length of any line in either file is 80 characters.
- 15** No process options were used.

Examples of comparison listings

The following represent some of the output types available from SuperC.

```

1 ASMFUPC - MVS FILE/LINE/WORD/BYTE/SFOR COMPARE UTILITY- V1R6M0 (07/11/2008) 07/11/2008 12.31 PAGE 1
NEW: D1 A A OLD: D2 A A

LISTING OUTPUT SECTION (LINE COMPARE)

ID SOURCE LINES TYPE LEN N-LN# O-LN#
-----1-----2-----3-----4-----5-----6-----7-----8
I - 970522 oE L MAT= 1
INFO Date cols 11:15 packed 20970522 comp=(2097 05 22) RPL= 1 00002 00002
D - 970522 oE L
INFO Date cols 11:14 packed 970522 comp=(1997 05 22)
1 ASMFUPC - MVS FILE/LINE/WORD/BYTE/SFOR COMPARE UTILITY- V1R6M0 (07/11/2008) 07/11/2008 12.31 PAGE 1
NEW: D1 A A OLD: D2 A A

LINE COMPARE SUMMARY AND STATISTICS

1 NUMBER OF LINE MATCHES 1 TOTAL CHANGES (PAIRED+NONPAIRED CHNG)
0 REFORMATTED LINES 1 PAIRED CHANGES (REFM+PAIRED INS/DEL)
1 NEW FILE LINE INSERTIONS 0 NON-PAIRED INSERTS
1 OLD FILE LINE DELETIONS 0 NON-PAIRED DELETES
2 NEW FILE LINES PROCESSED
2 OLD FILE LINES PROCESSED

LISTING-TYPE = DELTA COMPARE-COLUMNS = 1:72 LONGEST-LINE = 80
PROCESS OPTIONS USED: SEQ(DEFAULT)
THE FOLLOWING PROCESS STATEMENTS (USING COLUMNS 1:72) WERE PROCESSED:
Y2PAST 1987
NY2P 11:15 YYYYMMDD
OY2P 11:14 YYYYMMDD
NFOCUS COLS 1:20
OFOCUS COLS 1:20
    
```

Figure 257. Example of comparison listing with dates being compared

Understanding the listings

In Figure 257 on page 511, the two date definition process statements have each caused an information (“INFO”) line to be generated. The information line shows:

- The position of the defined date in the record.
- The contents of the defined date field.
- The date as it was *actually compared*. In the second information line, you can see the defined date has a 2-digit year portion (“97”) but has actually been compared using a 4-digit year portion (“1997”).

For further details, see “Date definitions” on page 492.

Note: Occasionally, you may see some “unusual” characters on the inserted (I) and deleted (D) lines. These characters represent data that is in a non-character (and therefore not directly printable) format in the input record. Ignore them.

```

1 ASMFUPC - MVS FILE/LINE/WORD/BYTE/SFOR COMPARE UTILITY- VIR6M0 (07/11/2008) 07/11/2008 14.38 PAGE 1
NEW: D1 A A OLD: D2 A A

LISTING OUTPUT SECTION (LINE COMPARE)

ID SOURCE LINES TYPE LEN N-LN# O-LN#
  Account Birth Surname MAT= 1
  Number Date RPL= 1 00002 00002
I - 111222 19970101 Jones
D - 111222 970102 Jones
1 ASMFUPC - MVS FILE/LINE/WORD/BYTE/SFOR COMPARE UTILITY- VIR6M0 (07/11/2008) 07/11/2008 14.38 PAGE 1
NEW: D1 A A OLD: D2 A A

LINE COMPARE SUMMARY AND STATISTICS

1 NUMBER OF LINE MATCHES 1 TOTAL CHANGES (PAIRED+NONPAIRED CHNG)
0 REFORMATTED LINES 1 PAIRED CHANGES (REFM+PAIRED INS/DEL)
1 NEW FILE LINE INSERTIONS 0 NON-PAIRED INSERTS
1 OLD FILE LINE DELETIONS 0 NON-PAIRED DELETES
2 NEW FILE LINES PROCESSED
2 OLD FILE LINES PROCESSED

LISTING-TYPE = DELTA COMPARE-COLUMNS = 1:72 LONGEST-LINE = 80
PROCESS OPTIONS USED: SEQ(DEFAULT)
THE FOLLOWING PROCESS STATEMENTS (USING COLUMNS 1:72) WERE PROCESSED:
COLHEAD 'Account','Number',1:8,N 1:6 C,0 1:6 C
COLHEAD 'Birth','Date',10:20,N 7:11 P,0 7:10 P
COLHEAD 'Surname',,22:61,N 12:51 C,0 11:50 C

```

Figure 258. Example of comparison listing with column headings (Using COLHEAD)

In Figure 258, COLHEAD process statements have been used to generate column headings (“Account Number”, “Birth Date”, and “Surname”) for the corresponding input data. For further details, see “Define column headings” on page 481.

```

1 ASMFUPC - MVS FILE/LINE/WORD/BYTE/SFOR COMPARE UTILITY- VIR6M0 (07/11/2008) 07/11/2008 15.10
NEW: JLEVERIN TEST2 A OLD: JLEVERIN TEST1

LISTING OUTPUT SECTION (LINE COMPARE)

ID NEW FILE LINES ID OLD FILE LINES N-LN# O-LN#
-----1-----2|5-----|-----1-----2|5---
RN-This line is reforma... " file | RO-This line is reforma... "new 00001 00001
This line is the sam... This line is the sam... 00002 00002
I -This line differs fr... | D -This line differs fr... 00003 00003
This line is the sam... | This line is the sam... 00004 00004
I -This line is in the... |d". | 00005

1 ASMFUPC - MVS FILE/LINE/WORD/BYTE/SFOR COMPARE UTILITY- VIR6M0 (07/11/2008) 07/11/2008 15.10
NEW: JLEVERIN TEST2 A OLD: JLEVERIN TEST1

LINE COMPARE SUMMARY AND STATISTICS

2 NUMBER OF LINE MATCHES 3 TOTAL CHANGES (PAIRED+NONPAIRED CHNG)
1 REFORMATTED LINES 2 PAIRED CHANGES (REFM+PAIRED INS/DEL)
2 NEW FILE LINE INSERTIONS 1 NON-PAIRED INSERTS
1 OLD FILE LINE DELETIONS 0 NON-PAIRED DELETES
5 NEW FILE LINES PROCESSED
4 OLD FILE LINES PROCESSED

LISTING-TYPE = CHNG COMPARE-COLUMNS = 1:72 LONGEST-LINE = 80
PROCESS OPTIONS USED: SEQ(DEFAULT) NARROW NOPRTCC

**ASMFUPC INFORM0**, LISTING LINES MAY BE TRUNCATED DUE TO LIMITING OUTPUT LINE WIDTH.

```

Figure 259. Example of a NARROW side-by-side listing

In Figure 259 on page 512, the *new* and *old* files are shown side-by-side. The NARROW listing type allows SuperC to output 55 columns from each file. Notice how the inserts and deletes are horizontally aligned with each other.

```

1 ASMFSUPC - MVS FILE/LINE/WORD/BYTE/SFOR COMPARE UTILITY- V1R6M0
NEW: JLEVERIN TEST2 A OLD: JLEVERIN TEST1

LISTING OUTPUT SECTION (LINE COMPARE)

ID          NEW FILE LINES          ID          OLD FILE LINES          N-LN# O-LN#
----+----1----+----2|...|5----+  ----+----1----+----2|...|5---
RN-This line is reforma...|" file | RO-This line is reforma...|"new 00001 00001
  This line is the sam...|.         |   This line is the sam...|.         |   00002 00002
I -This line differs fr...|.         | D -This line differs fr...|.         |   00003 00003
  This line is the sam...|.         |   This line is the sam...|.         |   00004 00004
I -This line is in the |...|ld". |   This line is in the |...|ld". |   00005

1 ASMFSUPC - MVS FILE/LINE/WORD/BYTE/SFOR COMPARE UTILITY- V1R6M0
NEW: JLEVERIN TEST2 A OLD: JLEVERIN TEST1

LINE COMPARE SUMMARY AND STATISTICS

2 NUMBER OF LINE MATCHES          3 TOTAL CHANGES (PAIRED+NONPAIRED CHNG)
1 REFORMATTED LINES              2 PAIRED CHANGES (REFM+PAIRED INS/DEL)
2 NEW FILE LINE INSERTIONS       1 NON-PAIRED INSERTS
1 OLD FILE LINE DELETIONS        0 NON-PAIRED DELETES
5 NEW FILE LINES PROCESSED
4 OLD FILE LINES PROCESSED

LISTING-TYPE = CHNG COMPARE-COLUMNS = 1:72 LONGEST-LINE = 80
PROCESS OPTIONS USED: SEQ(DEFAULT) NARROW DLMDUP NOPRTCC

**ASMFSUPC INFORM04**, LISTING LINES MAY BE TRUNCATED DUE TO LIMITING OUTPUT LINE
WIDTH.
```

Figure 260. Example of a NARROW side-by-side listing (with DLMDUP)

Figure 260, is like the previous example (Figure 259 on page 512) except that the process option DLMDUP has been used to suppress the matched lines from the *old* file section. This simplifies the combined listing output, allowing the changes to stand out more clearly.

Understanding the listings

```

1 ASMFSUPC - MVS FILE/LINE/WORD/BYTE/SFOR COMPARE UTILITY- V1R6M0
NEW: JLEVERIN TEST2 A OLD: JLEVERIN TEST1

LISTING OUTPUT SECTION (LINE COMPARE)

ID          N |...| ID          0 |...| TYPE LEN TYPE LEN N-LN# O-LN#
----+-----1 |...| +-----8  ----+-----1 |...| +-----8
RN-This line |...| 000100 |RO-This line |...| 000100 RFM= 1 00001 00001
This line   |...| 000200 |...| MAT= 1 00002 00002
I -This line |...| 000300 |D -This line |...| 000300 INS= 1 DEL= 1 00003 00003
This line   |...| 000400 |...| MAT= 1 00004 00004
I -This line |...| 000500 |...| INS= 1 00005

1 ASMFSUPC - MVS FILE/LINE/WORD/BYTE/SFOR COMPARE UTILITY- V1R6M0
NEW: JLEVERIN TEST2 A OLD: JLEVERIN TEST1

LINE COMPARE SUMMARY AND STATISTICS

2 NUMBER OF LINE MATCHES          3 TOTAL CHANGES (PAIRED+NONPAIRED CHNG)
1 REFORMATTED LINES              2 PAIRED CHANGES (REFM+PAIRED INS/DEL)
2 NEW FILE LINE INSERTIONS       1 NON-PAIRED INSERTS
1 OLD FILE LINE DELETIONS        0 NON-PAIRED DELETES
5 NEW FILE LINES PROCESSED
4 OLD FILE LINES PROCESSED

LISTING-TYPE = CHNG COMPARE-COLUMNS = 1:72 LONGEST-LINE = 80
PROCESS OPTIONS USED: SEQ(DEFAULT) WIDE DLMDUP NOPRTCC

```

Figure 261. Example of a WIDE side-by-side listing

In Figure 261, the *new* and *old* files are shown side-by-side in a WIDE listing. SuperC lists 80 columns from each file. Notice how the inserts and deletes are horizontally aligned with each other.

Note: The output file has a LRECL of 202/203 and may require special processing and printer capability to obtain a hard copy. Refer to the previous NARROW option examples if the large LRECL requirement cannot be satisfied and a side-by-side listing is still required.

```

1 ASMFUPC - MVS FILE/LINE/WORD/BYTE/SFOR COMPARE UTILITY- VIR6M0 (07/11/2008) 07/11/2008 16.46
NEW: PACKAGE ANNOUNCE A1 + SELECTF FILE LIST OLD: PACKAGE

MEMBER SUMMARY LISTING (FILE COMPARE)

DIFF SAME FILE NAMES N-BYTES O-BYTES N-LINES

** PACKAGE ANNOUNCE A1:PACKAGE ANNOUNCE E1 11210 51148 241
** PACKAGE EXEC A5:PACKAGE EXEC E5 151749 151646 4311
** ** PACKAGE HELP A5:PACKAGE HELP E5 70683 70683 1631
** PACKAGE HELPCMS A5:PACKAGE HELPCMS E1 58 65 4
** PACKAGE MENU A5:PACKAGE MENU E5 16803 16803 426
** PACKAGE MODULE A1:PACKAGE MODULE E1 127604 126076 4
** ** PACKAGE PACKAGE A5:PACKAGE PACKAGE E5 2408 2408 42
-----
GROUP TOTALS 380515 418829 6659

Column 78 ----->0-LINES N-HASH-SUM O-HASH-SUM
Column 80 ----->1147 C18E675F F5CE6031
(Continuation of previous data lines) 4310 2D2DF797 E0F1D820
1631 8A05CE27 8A05CE27
6 B1879676 F011E226
426 BAC0D5A9 BABFD5A9
4 4DF43D5A 3E820FA9
42 B29FA936 B29FA936
-----
7566

7 TOTAL FILES PROCESSED AS A GROUP
5 TOTAL FILES PROCESSED HAD CHANGES
2 TOTAL FILES PROCESSED HAD NO CHANGES
0 TOTAL NEW FILES NOT PAIRED
0 TOTAL OLD FILES NOT PAIRED

THE FOLLOWING PROCESS STATEMENT(S) WERE PROCESSED:
SELECTF PACKAGE ANNOUNCE A1 PACKAGE ANNOUNCE E1
SELECTF PACKAGE EXEC A5 PACKAGE EXEC E5
SELECTF PACKAGE HELP A5 PACKAGE HELP E5
SELECTF PACKAGE HELPCMS A5 PACKAGE HELPCMS E1
SELECTF PACKAGE MENU A5 PACKAGE MENU E5
SELECTF PACKAGE MODULE A1 PACKAGE MODULE E1
SELECTF PACKAGE PACKAGE A5 PACKAGE PACKAGE E5
    
```

Figure 262. Example of a FILE comparison of a file group

Figure 262 shows a collection of files and statistics for the specified SELECTF designated file group. Some files are the same and some files differ.

Understanding the listings

```

1 ASMFUPC - MVS FILE/LINE/WORD/BYTE/SFOR COMPARE UTILITY- V1R6M0
NEW: PACKAGE ANNOUNCE A1 + SELECTF FILE LIST OLD: PACKAGE

MEMBER SUMMARY LISTING (FILE COMPARE)

DIFF SAME FILE NAMES N-BYTES O-BYTES N-LINES

** PACKAGE ANNOUNCE A1:PACKAGE ANNOUNCE E1 11210 51148 241
** PACKAGE EXEC A5:PACKAGE EXEC E5 151749 151646 4311
** PACKAGE HELPCMS A5:PACKAGE HELPCMS E1 58 65 4
** PACKAGE MENU A5:PACKAGE MENU E5 16803 16803 426
** PACKAGE MODULE A1:PACKAGE MODULE E1 127604 126076 4
-----
GROUP TOTALS 380515 418829 6659

Column 78 ----->O-LINES N-HASH-SUM O-HASH-SUM
Column 80 ----->1147 C18E675F F5CE6031
(Continuation of previous data lines) 4310 2D2DF797 E0F1D820
6 B1879676 F011E226
426 BAC0D5A9 BABFD5A9
4 4DF43D5A 3E820FA9
-----
7566

7 TOTAL FILES PROCESSED AS A GROUP
5 TOTAL FILES PROCESSED HAD CHANGES
2 TOTAL FILES PROCESSED HAD NO CHANGES
0 TOTAL NEW FILES NOT PAIRED
0 TOTAL OLD FILES NOT PAIRED

PROCESS OPTIONS USED: LOCS

THE FOLLOWING PROCESS STATEMENT(S) WERE PROCESSED:
SELECTF PACKAGE ANNOUNCE A1 PACKAGE ANNOUNCE E1
SELECTF PACKAGE EXEC A5 PACKAGE EXEC E5
SELECTF PACKAGE HELP A5 PACKAGE HELP E5
SELECTF PACKAGE HELPCMS A5 PACKAGE HELPCMS E1
SELECTF PACKAGE MENU A5 PACKAGE MENU E5
SELECTF PACKAGE MODULE A1 PACKAGE MODULE E1
SELECTF PACKAGE PACKAGE A5 PACKAGE PACKAGE E5

```

Figure 263. Example of a FILE comparison of a file group (with LOCS)

Figure 263 is like the previous example (Figure 262 on page 515) except that the LOCS process option has been used to limit the output to files from the file group which were found to be different. This option can greatly reduce the volume of output when the total number of files is secondary to the change activity in the group.

```

1 ASMFUPC - MVS FILE/LINE/WORD/BYTE/SFOR COMPARE UTILITY- V1R6M0
NEW: JLEVERIN TEST2 A OLD: JLEVERIN TEST1 A

LISTING OUTPUT SECTION (WORD COMPARE)

ID SOURCE LINES (COMPARED COLUMNS) N-LN# O-LN#

This line is reformatted; the spacing in the "new" file differs 00001 00001
This line is the same in both files. 00002 00002
MC-This line differs from the text in the file. 00003 00003
IC- "old" 00003 00003
DC- "new" 00003 00003
This line is the same in both files. 00004 00004
I -This line is in the "new" file, but not in the "old". 00005 00004
1 ASMFUPC - MVS FILE/LINE/WORD/BYTE/SFOR COMPARE UTILITY- V1R6M0
NEW: JLEVERIN TEST2 A OLD: JLEVERIN TEST1 A

WORD COMPARE SUMMARY AND STATISTICS

40 NUMBER OF WORD MATCHES 14 TOTAL CHANGES (PAIRED+NONPAIRED CHNG)
14 NEW FILE WORD INSERTIONS 2 NEW FILE LINES CHANGED/INSERTED
1 OLD FILE WORD DELETIONS 1 OLD FILE LINES CHANGED/DELETED
54 NEW FILE WORDS PROCESSED 5 NEW FILE LINES PROCESSED
41 OLD FILE WORDS PROCESSED 4 OLD FILE LINES PROCESSED

LISTING-TYPE = LONG COMPARE-COLUMNS = 1:80 LONGEST-LINE = 80
PROCESS OPTIONS USED: NONE

```

Figure 264. Example of a WORD comparison

Figure 264 is an output listing from a comparison using the WORD compare type and shows how the output lines differ when the comparison is made at the WORD level. The deleted words are normally listed under the replacement (inserted) words. Separate (both inserted and deleted) lines are listed when completely changed lines are detected.

The search listing

The typical search listing is composed of three parts:

- Page Heading
- Source Lines Section
- Summary Section

Page heading

SuperC generates a page heading at the top of each page.

```

1 ASMFUPC - MVS FILE/LINE/WORD/BYTE/SFOR COMPARE UTILITY- V1R6M0 (04/20/2004) 07/11/2008 12.32 PAGE 1

```

Figure 265. Example of the page heading line for the search listing

Figure 265 shows a typical page heading line. It contains:

- Printer control page eject character (“1” in column one. not present when the NOPRTCC process option is specified).
- “Platform-identifier”. This shows “MVS”.
- Program identification title including version and the version date: V1R6M0 (07/11/2008).
- The date and time of the search
- The page number.

Understanding the listings

Note: The program version and program date are important when reporting suspected SuperC problems.

Source lines section

The source lines section provides detailed information about the results of the Search.

Figure 266 is an example showing the source line section. Only one character string

1	LINE-#	SOURCE LINES	SRCH FN: NEW1 TESTCASE C
2	1	This NEW file is FIXED 80 with Sequence Numbers	
	2	/** NEW: To get rid of this PLI/REXX type comment, use DPPLCMT	
	3	(** NEW: To get rid of this PASCAL type comment, use DPPSCMT.	
	4	! * NEW: Use DPPDCMT for this comment.	
	5	* * NEW: Use DPACMT to remove this assembler type comment	
	6	-- *NEW: Use DPADCMT to remove this line.	
	7	* * NEW: COBOL comment. Remove with DPCBCMT.	
	8	C * NEW: FORTRAN comment. Remove with DPFTCMT.	
	9	&&& This NEW line comes out with a DPLINE '&&&'	

Figure 266. Example of the source lines section of a search listing

("NEW") was specified for the search.

1 Column Header Line.

LINE-#

Relative line number of the line where the string was found.

SOURCE LINES

Up to 106 characters of the source line where the string was found.

SRCH FN:

Identifies the file which was searched. In this example, it is NEW1 TESTCASE C.

2 Text Lines. Relative line numbers and text lines from the search file where the string "NEW" was found.

The format of the source lines section changes when certain process options are used:

IDPFX ("Identifier Prefixed")

The file ID is prefixed to each line of source text. See "Source lines section (IDPFX)."

LMTO ("List Group Member Totals")

Only the totals of lines found and processed are listed. See "Source lines section (LMTO)" on page 519.

XREF ("Cross-reference Strings")

Creates a cross-reference listing by search string. See "Source lines section (XREF)" on page 520.

Note: the XREF process option also generates additional totals for each search string in the summary section.

Source lines section (IDPFX)

The source line section generated when the IDPFX process option is used is like the normal source line section but with the search file ID preceding each line of source text. See Figure 267 on page 519.

1	FNAME	FTYPE	FM	LINE-#	SOURCE-LNS	SRCH FN: NEW1 TESTCASE C
2	NEW1	TESTCASE C1		1	This NEW file is FIXED 80 with Seque	
	NEW1	TESTCASE C1		2	/** NEW: To get rid of this PLI/REXX type comm	
	NEW1	TESTCASE C1		3	(** NEW: To get rid of this PASCAL type commen	
	NEW1	TESTCASE C1		4	! * NEW: Use DPPDCMT for this comment.	
	NEW1	TESTCASE C1		5	* * NEW: Use DPACMT to remove this assembler t	
	NEW1	TESTCASE C1		6	-- *NEW: Use DPADCMT to remove this line.	
	NEW1	TESTCASE C1		7	* * * NEW: COBOL comment. Remove with DPCBC	
	NEW1	TESTCASE C1		8	C * NEW: FORTRAN comment. Remove with DPFTCMT	
	NEW1	TESTCASE C1		9	&&& This NEW line comes out with a DPLINE '&&&	

Figure 267. Example of the IDPFIX source lines section of a search listing

- 1** Column Header Line.
- FNAME**
File name (fn) of the file where in the string was found.
- FTYPE**
File type (ft) of the file where in the string was found.
- FM** File mode (fm) of the file where in the string was found.
- LINE-#**
Relative line number of the line where the string was found.
- SOURCE-LNS**
Up to 106 characters of the source line where the string was found.
- SRCH FN:**
In this example, the search file ID is NEW1 TESTCASE C.
- 2** The search file ID, relative line number, and text line from the search file where the string was found.

Source lines section (LMTO)

The LMTO process option generates a listing showing the total number of lines found and processed for each file. (The individual lines found are not listed.) See Figure 268.

1	FILES-SEARCHED	LINES-FOUND	LINES-PROC
2	NEW1 TESTCASE C1	9	9
	NEW13 TESTCASE C1	10	15

Figure 268. Example of the LMTO source lines section of a search listing

- 1** Column Header Line.
- FILES-SEARCHED**
Identifies the files which were searched.
- LINES-FOUND**
Number of the lines found containing one or more of the search strings. The line is only counted once no matter how many search strings were found in the line.
- LINES-PROC**
Number of lines in the file that were searched. Does not include "Do not Process" lines.
- 2** Individual file totals.

Understanding the listings

Source lines section (XREF)

The XREF process option creates a cross-reference listing where the source lines are listed by search strings.

In Figure 269, lines which contain the string "NEW" in NEW1 TESTCASE C1 are listed first, then lines which contain the string "NEW" in NEW13 TESTCASE C1, then lines which contain the string "USE" in NEW1 TESTCASE C1, and finally those lines which contain the string "USE" in NEW13 TESTCASE C1.

```
1 ----- STRING="NEW"                IN NEW1    TESTCASE C1 -----
2     1      This NEW file is FIXED 80 with Sequence Numbers
3     2     /** NEW: To get rid of this PLI/REXX type comment, use DPPLCMT. */
4     3     (** NEW: To get rid of this PASCAL type comment, use DPPSCMT. *)
5
6
7
8
9
10
11
12
13
14
15
16
17
18
19
20
21
22
23
24
25
26
27
28
29
30
31
32
33
34
35
36
37
38
39
40
41
42
43
44
45
46
47
48
49
50
51
52
53
54
55
56
57
58
59
60
61
62
63
64
65
66
67
68
69
70
71
72
73
74
75
76
77
78
79
80
81
82
83
84
85
86
87
88
89
90
91
92
93
94
95
96
97
98
99
100
101
102
103
104
105
106
107
108
109
110
111
112
113
114
115
116
117
118
119
120
121
122
123
124
125
126
127
128
129
130
131
132
133
134
135
136
137
138
139
140
141
142
143
144
145
146
147
148
149
150
151
152
153
154
155
156
157
158
159
160
161
162
163
164
165
166
167
168
169
170
171
172
173
174
175
176
177
178
179
180
181
182
183
184
185
186
187
188
189
190
191
192
193
194
195
196
197
198
199
200
201
202
203
204
205
206
207
208
209
210
211
212
213
214
215
216
217
218
219
220
221
222
223
224
225
226
227
228
229
230
231
232
233
234
235
236
237
238
239
240
241
242
243
244
245
246
247
248
249
250
251
252
253
254
255
256
257
258
259
260
261
262
263
264
265
266
267
268
269
270
271
272
273
274
275
276
277
278
279
280
281
282
283
284
285
286
287
288
289
290
291
292
293
294
295
296
297
298
299
300
301
302
303
304
305
306
307
308
309
310
311
312
313
314
315
316
317
318
319
320
321
322
323
324
325
326
327
328
329
330
331
332
333
334
335
336
337
338
339
340
341
342
343
344
345
346
347
348
349
350
351
352
353
354
355
356
357
358
359
360
361
362
363
364
365
366
367
368
369
370
371
372
373
374
375
376
377
378
379
380
381
382
383
384
385
386
387
388
389
390
391
392
393
394
395
396
397
398
399
400
401
402
403
404
405
406
407
408
409
410
411
412
413
414
415
416
417
418
419
420
421
422
423
424
425
426
427
428
429
430
431
432
433
434
435
436
437
438
439
440
441
442
443
444
445
446
447
448
449
450
451
452
453
454
455
456
457
458
459
460
461
462
463
464
465
466
467
468
469
470
471
472
473
474
475
476
477
478
479
480
481
482
483
484
485
486
487
488
489
490
491
492
493
494
495
496
497
498
499
500
501
502
503
504
505
506
507
508
509
510
511
512
513
514
515
516
517
518
519
520
521
522
523
524
525
526
527
528
529
530
531
532
533
534
535
536
537
538
539
540
541
542
543
544
545
546
547
548
549
550
551
552
553
554
555
556
557
558
559
560
561
562
563
564
565
566
567
568
569
570
571
572
573
574
575
576
577
578
579
580
581
582
583
584
585
586
587
588
589
590
591
592
593
594
595
596
597
598
599
600
601
602
603
604
605
606
607
608
609
610
611
612
613
614
615
616
617
618
619
620
621
622
623
624
625
626
627
628
629
630
631
632
633
634
635
636
637
638
639
640
641
642
643
644
645
646
647
648
649
650
651
652
653
654
655
656
657
658
659
660
661
662
663
664
665
666
667
668
669
670
671
672
673
674
675
676
677
678
679
680
681
682
683
684
685
686
687
688
689
690
691
692
693
694
695
696
697
698
699
700
701
702
703
704
705
706
707
708
709
710
711
712
713
714
715
716
717
718
719
720
721
722
723
724
725
726
727
728
729
730
731
732
733
734
735
736
737
738
739
740
741
742
743
744
745
746
747
748
749
750
751
752
753
754
755
756
757
758
759
760
761
762
763
764
765
766
767
768
769
770
771
772
773
774
775
776
777
778
779
780
781
782
783
784
785
786
787
788
789
790
791
792
793
794
795
796
797
798
799
800
801
802
803
804
805
806
807
808
809
810
811
812
813
814
815
816
817
818
819
820
821
822
823
824
825
826
827
828
829
830
831
832
833
834
835
836
837
838
839
840
841
842
843
844
845
846
847
848
849
850
851
852
853
854
855
856
857
858
859
860
861
862
863
864
865
866
867
868
869
870
871
872
873
874
875
876
877
878
879
880
881
882
883
884
885
886
887
888
889
890
891
892
893
894
895
896
897
898
899
900
901
902
903
904
905
906
907
908
909
910
911
912
913
914
915
916
917
918
919
920
921
922
923
924
925
926
927
928
929
930
931
932
933
934
935
936
937
938
939
940
941
942
943
944
945
946
947
948
949
950
951
952
953
954
955
956
957
958
959
960
961
962
963
964
965
966
967
968
969
970
971
972
973
974
975
976
977
978
979
980
981
982
983
984
985
986
987
988
989
990
991
992
993
994
995
996
997
998
999
1000
```

Figure 269. Example of the XREF source lines section (with ANYC)

```
1 Sub-section line showing string "NEW" and file NEW1 TESTCASE C1.
2 Line number and text of line where string was found.
3 Sub-section line showing file NEW13 TESTCASE C1 (string is still "NEW").
4 Line number and text of line where string was found.
5 Sub-section line showing string "USE" and file NEW1 TESTCASE C1.
6 Line number and text of line where string was found.
7 Sub-section line showing file NEW13 TESTCASE C1 (string is still "USE").
8 Line number and text of line where string was found.
```

Summary section

The summary section (see Figure 270) provides various totals resulting from the search and shows any process statements which were used.

1	LINE-#	SOURCE LINES		SRCH FN:	NEW1 TESTCASE C
2	LINES-FOUND	FILES-W/LNS	FILES-PROC	LINES-PROC	COMPARE-COLS
3	9	1	1	9	1: 80
4	THE FOLLOWING PROCESS STATEMENT(S) WERE PROCESSED:				
	SRCHFOR 'NEW'				

Figure 270. Example of the summary section of a search listing

The summary section consists of:

- 1** A section heading line.
- 2** A column heading line.
- 3** One line of totals.
- 4** A multi-line section (two lines in Figure 270) showing the process statements which were used.

XREF summary section

When the XREF process option (“Cross-reference Strings”) is used, additional lines are included in the summary section. In Figure 271, these are lines **2**, **3**, and **4**. The totals are listed according to each search string.

Note: The XREF summary section may be produced without the XREF source line section by using the LMTO process option.

1	SUMMARY SECTION			SRCH FN:	NEW1* TESTCASE C
2	STRING-FOUND	LINES-FOUND	FILES-W/LNS	STRING-NOT-FOUND	
3	"NEW"	19	2		
4	"USE"	10	2		
5	LINES-FOUND	FILES-W/LNS	FILES-PROC	LINES-PROC	COMPARE-COLS
6	29	2	5	64	1: 80

Figure 271. Example of the XREF summary section of a search listing

- 1** Section header line. Identifies the file which was searched. In this example, it is NEW1* TESTCASE C.
- 2** Column header line.
 - STRING-FOUND**
Column indicating the search string.
 - LINES-FOUND**
Lines which contained one or more occurrences of the search string.

Understanding the listings

FILES-W/LNS

Total number of files in the group in which the string was found.

STRING-NOT-FOUND

Indication that the string was not found in any of the files in the file group.

3 Totals for string "NEW"

4 Totals for string "USE"

5 Column header line.

LINES-FOUND

The summation of lines found for the individual search strings.

FILE-W/LNS

Number of files where lines were found to contain one or more of the search strings.

FILE-PROC

Number of files that were searched.

LINES-PROC

Number of lines that were part of the search set.

COMPARE-COLS

The column range that was searched.

6 Totals statistics arranged under the columns specified in **5**.

Examples of search listings

Search of one file

Figure 272 shows the 3 parts of a search listing: page heading, source lines section, and summary section.

```
1      ASMFUPC - MVS LINE/WORD/BYTE COMPARE UTILITY - V1R6M0 (07/11/2008)
LINE-#  SOURCE LINES                SRCH FN: NEW1  TESTCASE C

2  /** NEW: To get rid of this PLI/REXX type comment, use DPPLCMT. */
3  (** NEW: To get rid of this PASCAL type comment, use DPPSCMT. *)
5  * * NEW: Use DPACMT to remove this assembler type comment.
6  -- *NEW: Use DPACMT to remove this line.

1      ASMFUPC - MVS LINE/WORD/BYTE COMPARE UTILITY - V1R6M0 (07/11/2008) 07/11/2008
      SUMMARY SECTION                SRCH FN: NEW1  TESTCASE C

LINES-FOUND  FILES-W/LNS  FILES-PROC  LINES-PROC  COMPARE-COLS  LONGEST-LINE
          4             1             1             9           1: 80         80

THE FOLLOWING PROCESS STATEMENT(S) WERE PROCESSED:
  SRCHFOR  'remove'
  SRCHFOR  'rid'
```

Figure 272. Example of the search listing (single file)

IDPFX search of file group

The file group NEW1* TESTCASE C composed of 5 files was searched and 8 lines within 2 files had "remove" and "rid" as the search arguments.

```

1 ASMFUPC - MVS FILE/LINE/WORD/BYTE/SFOR COMPARE UTILITY- V1R6M0
  FNAME  FTYPE  FM  LINE-#  SOURCE-LNS  SRCH FN: NEW1*  TESTCASE C

NEW1  TESTCASE C1      2  /** NEW: To get rid of this PLI/REXX type comment
NEW1  TESTCASE C1      3  (** NEW: To get rid of this PASCAL type comment,
NEW1  TESTCASE C1      5  * * NEW: Use DPACMT to remove this assembler type
NEW1  TESTCASE C1      6  -- *NEW: Use DPADCMT to remove this line.

NEW13 TESTCASE C1      2  /** NEW: To get rid of this PLI/REXX type comment
NEW13 TESTCASE C1      3  (** NEW: To get rid of this PASCAL type comment,
NEW13 TESTCASE C1      5  * * NEW: Use DPACMT to remove this assembler type
NEW13 TESTCASE C1      6  -- *NEW: Use DPADCMT to remove this line.

1 ASMFUPC - MVS FILE/LINE/WORD/BYTE/SFOR COMPARE UTILITY- V1R6M0
  SUMMARY SECTION                                SRCH FN: NEW1*  TESTCASE C

LINES-FOUND  FILES-W/LNS  FILES-PROC  LINES-PROC  COMPARE-COLS  LONGEST-LIN
           8           2           5           64           1: 80           80

PROCESS OPTIONS USED: IDPFIX

THE FOLLOWING PROCESS STATEMENT(S) WERE PROCESSED:
  SRCHFOR  'remove'
  SRCHFOR  'rid'

```

Figure 273. Example of IDPFIX search on file group

XREF search of file group for two strings

XREF sorts the search string occurrences before producing a listing. The example shows a listing when both strings are found in the file group.

```

1 ASMFUPC - MVS FILE/LINE/WORD/BYTE/SFOR COMPARE UTILITY- V1R6M0
  LINE-#  SOURCE LINES                                SRCH FN: NEW1*  TESTCASE C

----- STRING="remove"                                IN NEW1  TESTCASE C1 -----

      5  * * NEW: Use DPACMT to remove this assembler type comment.
      6  -- *NEW: Use DPADCMT to remove this line.

-----
                                IN NEW13  TESTCASE C1 -----

      5  * * NEW: Use DPACMT to remove this assembler type comment.
      6  -- *NEW: Use DPADCMT to remove this line.

----- STRING="rid"                                    IN NEW1  TESTCASE C1 -----

      2  /** NEW: To get rid of this PLI/REXX type comment, use DPPLCMT. */
      3  (** NEW: To get rid of this PASCAL type comment, use DPPSCMT. *)

-----
                                IN NEW13  TESTCASE C1 -----

:

THE FOLLOWING PROCESS STATEMENT(S) WERE PROCESSED:
  SRCHFOR  'remove'
  SRCHFOR  'rid'

```

Figure 274. Example of XREF search on file group for two strings

Understanding the listings

LMTO search of file group

LMTO produces only the summary section for the search operation.

```
1 ASMFUPC - MVS FILE/LINE/WORD/BYTE/SFOR COMPARE UTILITY- V1R6M0
  FILE TOTALS SECTION                               SRCH FN: NEW1* TESTCASE C

  FILES-SEARCHED      LINES-FOUND   LINES-PROC
NEW1 TESTCASE C1      4           9
NEW13 TESTCASE C1     4           15

1 ASMFUPC - MVS FILE/LINE/WORD/BYTE/SFOR COMPARE UTILITY- V1R6M0
  SUMMARY SECTION                                   SRCH FN: NEW1* TESTCASE C

LINES-FOUND   FILES-W/LNS   FILES-PROC   LINES-PROC   COMPARE-COLS   LONGEST-LIN
      8             2             5             64             1: 80             80

PROCESS OPTIONS USED: LMTO

THE FOLLOWING PROCESS STATEMENT(S) WERE PROCESSED:
SRCHFOR 'remove'
SRCHFOR 'rid'
```

Figure 275. Example of LMTO search on file group

LMTO search of file group using the XREF process option

This is another example of a summary only output. Contrasting with the previous example, the string totals are sorted before being listed.

```
1 ASMFUPC - MVS FILE/LINE/WORD/BYTE/SFOR COMPARE UTILITY- V1R6M0
  XREF TOTALS SECTION                               SRCH FN: NEW1* TESTCASE C

  STRING-USED      FILES-SEARCHED      LINES-FOUND   LINES-PROC
"remove"          NEW1 TESTCASE C1      2           10
                  NEW13 TESTCASE C1      2           16

"rid"            NEW1 TESTCASE C1      2           10
                  NEW13 TESTCASE C1      2           16

1 ASMFUPC - MVS FILE/LINE/WORD/BYTE/SFOR COMPARE UTILITY- V1R6M0
  SUMMARY SECTION                                   SRCH FN: NEW1* TESTCASE C

STRING-FOUND      LINES-FOUND   FILES-W/LNS      STRING-NOT-FOUND
"remove"          4             2
"rid"            4             2

LINES-FOUND   FILES-W/LNS   FILES-PROC   LINES-PROC   COMPARE-COLS   LONGEST-LIN
      8             2             5             64             1: 80             80

PROCESS OPTIONS USED: LMTO XREF

THE FOLLOWING PROCESS STATEMENT(S) WERE PROCESSED:
SRCHFOR 'remove'
SRCHFOR 'rid'
```

Figure 276. Example of XREF/LMTO search of file group

LTO search of file group

LTO produces the overall totals section of the search results.

```

1 ASMFUPC - MVS FILE/LINE/WORD/BYTE/SFOR COMPARE UTILITY- V1R6M0
SUMMARY SECTION SRCH FN: NEW1* TESTCASE C

LINES-FOUND FILES-W/LNS FILES-PROC LINES-PROC COMPARE-COLS LONGEST-LIN
8 2 5 64 1: 80 80

PROCESS OPTIONS USED: LTO

THE FOLLOWING PROCESS STATEMENT(S) WERE PROCESSED:
SRCHFOR 'remove'
SRCHFOR 'rid'
    
```

Figure 277. Example of LTO search on file group

LPSF search of file group

The process option LPSF (“List Previous-Search-Following Lines”) lists lines before and after the search text detected line. The “*” in the line number column indicate they were part of the extra lines listed.

```

1 ASMFUPC - MVS FILE/LINE/WORD/BYTE/SFOR COMPARE UTILITY- V1R6M0
LINE-# SOURCE LINES SRCH FN: NEW1* TESTCASE C

NEW1 TESTCASE C1 ----- STRING(S) FOUND -----

* This line is reformatted; the spacing in the "new" member differs.
2 /** NEW: To get rid of this PLI/REXX type comment, use DPPLCMT. */
3 (** NEW: To get rid of this PASCAL type comment, use DPPSCMT. *)
* ! * NEW: Use DPPDCMT for this comment.
5 * * NEW: Use DPACMT to remove this assembler type comment.
6 -- *NEW: Use DPADCMT to remove this line.
* * * NEW: COBOL comment. Remove with DPCBCMT.
* C * NEW: FORTRAN comment. Remove with DPFTCMT.
* &&& This NEW line comes out with a DPLINE '&&&'

NEW13 TESTCASE C1 ----- STRING(S) FOUND -----

* This NEW file is FIXED 80 with Sequence Numbers
2 /** NEW: To get rid of this PLI/REXX type comment, use DPPLCMT. */
3 (** NEW: To get rid of this PASCAL type comment, use DPPSCMT. *)
    
```

Figure 278. Example of LPSF search on file group

Appendix C. Update files

An update file contains information relating to the result of a comparison and is generated when one of the *update* process options is specified:

- UPDCMS8 (“Update CMS sequenced 8 file” on page 529)
- UPDCNTL (“Update control files” on page 530)
- UPDLDEL (“Update long control” on page 534)
- UPDMVS8 (“Update MVS sequenced 8 file” on page 534)
- UPDPDEL (“Update prefixed delta lines” on page 535)
- UPDREV (“Revision file” on page 528)
- UPDREV2 (“Revision file (2)” on page 529)
- UPDSEQ0 (“Update sequenced 0 file” on page 536)
- UPDSUMO (“Update summary only files” on page 537)

Note:

1. UPDCMS8, UPDMVS8, UPDPDEL, UPDREV, UPDREV2, and UPDSEQ0 do not generate an update file after a comparison of matching files (Return Code = 0).
2. Dates, where applicable, in the heading lines of update files are in the format MM/DD/YYYY.
3. All “do not process” options, and DPLINE or CMPLINE process statements are invalid when used with the process options UPDCMS8, UPDMVS8, UPDSEQ0, UPDLDEL, and UPDPDEL. The “do not process” options are cancelled with error notification ASMF014.

Update files are normally used as input to post-processing programs and can be specified besides the normal listing output file.

On the following pages, descriptions and examples are given of the contents of the update file produced for each of the update (UPD...) process options.

In most of the examples shown, the same two input files are used. The contents of the *old* file are shown in Figure 279. The contents of the *new* file are shown in Figure 280.

This line is reformatted; the spacing in the "new" file differs.	00000100
This line is the same in both files.	00000200
This line differs from the text in the "new" file.	00000300
This line is the same in both files.	00000400

Figure 279. The “Old” input file used in most of the update examples

This line is reformatted; the spacing in the "new" file differs.	00000100
This line is the same in both files.	00000200
This line differs from the text in the "old" file.	00000300
This line is the same in both files.	00000400
This line is in the "new" file, but not in the "old".	00000500

Figure 280. The “New” input file used in most of the update examples

Revision file

The process option UPDREV produces an update file containing a copy of the *new* source text with revision tags delimiting the changed text lines.

The UPDREV process option is available for LINE and WORD compare types.

UPDREV supports two different types of revision tags, one for SCRIPT/VS files and one for BookMaster files. (Use the REVREF process statement ("Revision code reference" on page 486) to specify which type of revision tag you want.)

Figure 281 shows a SuperC UPDREV file with SCRIPT/VS revision tags (.rc on/off).

```
.rc 1 &vbar.  
.rc 1 on  
This line is reformatted; the spacing in the "new" file differs.  
.rc 1 off  
This line is the same in both files.  
.rc 1 on  
This line differs from the text in the "old" file.  
.rc 1 off  
This line is the same in both files.  
.rc 1 on  
This line is in the "new" file, but not in the "old".  
.rc 1 off
```

Figure 281. Example of a UPDREV update file for SCRIPT/VS documents

When the UPDREV update file in Figure 281 is processed by SCRIPT/VS, the final scripted output has "|" revision characters in the left margin of the output document identifying the changed lines (those between the SCRIPT/VS revision tags .rc 1 on and .rc 1 off).

Note: The revision character ("|" in the example in Figure 281) can be specified either by using a REVREF process statement (see "Revision code reference" on page 486) or by having a SCRIPT/VS .rc. revision tag as the first record in the *new* file. Subsequent changes to the source can therefore be separately identified by using different revision characters.

Figure 282 shows a SuperC UPDREV file with BookMaster revision tags (:rev/:erev).

```
This line is reformatted; the spacing in the "new" file differs.  
This line is the same in both files.  
This line differs from the text in the "old" file.  
This line is the same in both files.  
This line is in the "new" file, but not in the "old".
```

Figure 282. Example of a UPDREV update file for bookmaster documents

When the UPDREV update file in Figure 282 is processed by BookMaster, the final formatted output has the revision character associated with the revision ID abc (as specified by a :revision. BookMaster tag in the *new* input file) in the left margin of the output document identifying the changed lines (those between the BookMaster revision tags :rev and :erev).

Note: The revision ID (abc in the example in Figure 282 on page 528) is controlled by the REVREF process statement (see “Revision code reference” on page 486). Subsequent changes to the source can therefore be separately identified by using different revision IDs (which are associated with unique revision characters).

Revision file (2)

The process option UPDREV2 is identical to UPDREV with the exception that data between the following BookMaster tags are not deleted in the update file:

```
:cgraphic.
:ecgraphic.

:fig.
:efig.

:lblbox.
:elblbox.

:nt.
:ent.

:screen.
:escreen.

:table.
:etable.

:xmp.
:exmp.
```

Update CMS sequenced 8 file

The process option UPDCMS8 produces update files that are generally created for input to the CMS UPDATE command. The CMS UPDATE command is described in the *z/VM CMS Command Reference* manual.

The UPDCMS8 process option is available for the LINE compare type only.

The *old* input file must have fixed-length 80-byte records with valid sequence numbers in columns 73 through 80. The *new* file must be fixed but may have a length less than or equal to 80.

The UPDCMS8 update file is fixed-length 80.

If the sequence numbers do not allow adequate room to insert changes from the *new* file, SuperC changes the status of adjacent matched lines to find the room.

UPDCMS8 update files contain both CMS UPDATE control statements and source lines from the “new” file. All UPDCMS8 control statements are identified by the characters “./” in columns 1 and 2 of the 80-byte record, followed by one or more spaces and a one-character control line identifier. The control line identifiers are sequence (S), insert (I), delete (D), replace (R), and comment (*). Figure 283 on page 530 shows an example of a UPDCMS8 update file.

Update files

```
1 ./ * NEW: JLEVERIN TEST2   A                               07/11/2008 11.35
2 ./ * OLD: JLEVERIN TEST1   A
3 ./ R 00000100 00000100 $ 00000140 00000040
4 This line is reformatted; the spacing in the "new" file differs.    00000100
5 ./ R 00000300 00000300 $ 00000340 00000040
6 This line differs from the text in the "old" file.                  00000300
7 ./ I 00000400              $ 00001400 00001000
8 This line is in the "new" file, but not in the "old".              00000500
```

Figure 283. Example of a UPDCMS8 update file

The example in Figure 283, has the following lines:

- 1 Comment line. Lists the *new* file name and the date and time of the comparison.
- 2 Comment line. Lists the *old* file name.
- 3 Replacement control line. The first 8-digit numeric field is the sequence number (of the *old* file) of the first input number to be replaced. The second 8-digit numeric field is the sequence number of the *old* file that is the last record to be replaced. The dollar sign is an option separator field. The third and fourth 8-digit fields represent the first decimal number to be used for sequencing the substitute records and the decimal increment to be used in the sequencing.

In this example, the first line of the *old* file is being replaced with one line from the *new* file.
- 4 The *new* record which has replaced the *old* record at sequence number 00000100.
- 5 Another replacement control line.
- 6 The *new* record which has replaced the *old* record at sequence number 00000300.
- 7 Insert control line. After *old* line 4, there is a line inserted in the *new* file.
- 8 The text of the inserted line.

Update control files

The process option UPDCNTL produces a control file that relates matches, insertions, deletions, and reformats to:

- The relative line numbers of the *old* and *new* files (LINE compare type); see Figure 284 on page 531.
- The relative word position of the *old* file (WORD compare type); see Figure 285 on page 532.
- The relative byte offset (BYTE compare type); see Figure 286 on page 533.

Note: No source or data from either input file is included in the update file produced by UPDCNTL.

Update control file (LINE Compare Type)

```

1 * NEW: JLEVERIN TEST2 A 07/11/2008 12.45
2 * OLD: JLEVERIN TEST1 A
3 * N-LINE-# O-LINE-# MAT-LEN INS-LEN DEL-LEN REFM-LEN
4 00000001 00000001 00000001
5 00000002 00000002 00000001
6 00000003 00000003 00000001 00000001
7 00000004 00000004 00000001
8 00000005 00000005 00000001
9 * END

```

Figure 284. Example of a UPDCNTL update file using line compare type

- 1 Comment line. Lists the *new* file name and the date and time of the comparison.
- 2 Comment line. Lists the *old* file name.
- 3 Header Comment line. For information about the columns, see Table 27.
- 4 Shows that line 1 of the *new* file is a reformatted line of line 1 of the *old* file.
- 5 Line 2 from both files match.
- 6 Line 3 of the *new* file replaces line 3 of the *old* file.
- 7 Line 4 from both files match.
- 8 At line 5 of the *new* file is an inserted line.
- 9 Comment line. This is the end of the update file.

The following table shows the column numbers used for the UPDCNTL file:

Table 27. UPDCNTL update file format using LINE compare type

Column #	Identifier	Data Item
4-11	N-LINE-#	<i>New</i> line number
13-20	O-LINE-#	<i>Old</i> line number
22-29	MAT-LEN	Match length
31-38	INS-LEN	Insert length
40-47	DEL-LEN	Delete length
49-56	REFM-LEN	Reformat length
58-65	N-DP-LEN	(Not shown) <i>New</i> "Do not Process" length
67-74	O-DP-LEN	(Not shown) <i>Old</i> "Do not Process" length
76-80	N-MVL	(Not shown) <i>New</i> "moved" line length.

Update control file (WORD compare type)

```

1 * NEW: JLEVERIN TEST2 A 07/11/2008 12.17
2 * OLD: JLEVERIN TEST1 A
3 * N-LINE-# N-LN-LEN N-COL WD-MAT-# N-WD-INS O-WD-DEL O-LINE-# O-LN-LEN O-COL
4 00000001 00000003 00001 00000027 00000001 00000001 00000003 00000001 00001
5 00000003 00000001 00040 00000009 00000001 00000001 00000003 00000001 00040
6 00000003 00000002 00046 00000009 00000003 00000002 00046
7 00000005 00000001 00001 00000013
8 * END

```

Figure 285. Example of a UPDCNTL update file using WORD compare type

- 1** Comment line. Lists the *new* file name and the date and time of the comparison.
- 2** Comment line. Lists the *old* file name.
- 3** Header comment line. For information about the columns, see Table 28.
- 4** Beginning with line one column 1, of both files, the first twenty-seven words match. This takes us to line 3.
- 5** There is 1 word replaced in line 3. It begins in column forty of each file.
- 6** Beginning from the change in **5**, there are 9 more words that match.
- 7** A line of thirteen words was inserted at line 5.
- 8** Comment line. Ends the update file.

The following table shows the column numbers used for the UPDCNTL file:

Table 28. UPDCNTL update file format using WORD compare type

Column #	Identifier	Data Item
4-11	N-LINE-#	Beginning <i>new</i> line number
13-20	N-LN-LEN	Number of lines
22-26	N-COL	<i>New</i> column number (beginning of word)
28-35	WD-MAT-#	Number of matching words
37-44	N-WD-INS	Number of <i>new</i> inserted words
46-53	O-WD-DEL	Number of <i>old</i> deleted words
55-62	O-LINE-#	Beginning <i>old</i> line number
64-71	O-LN-LEN	Number of <i>old</i> lines
73-77	O-COL	<i>Old</i> column number

Update control file (BYTE compare type)

```

1 * NEW: JLEVERIN TEST2 A 07/11/2008 12.23
2 * OLD: JLEVERIN TEST1 A
3 * N-BYTE-O O-BYTE-O MAT-LEN INS-LEN DEL-LEN
4 00000000 00000000 0000001E
5 0000001E 0000001E 00000001 00000001
0000001E 0000001F 00000008
00000026 00000027 00000001 00000001
00000026 00000028 00000002
00000028 0000002A 00000001 00000001
00000028 0000002B 00000004
0000002C 0000002F 00000001 00000001
0000002C 00000030 00000007
00000033 00000037 00000001 00000001
00000033 00000038 00000004
00000037 0000003C 00000001 00000001
00000037 0000003D 00000009
00000040 00000046 00000006
00000046 00000046 00000082
6 000000C8 000000C8 00000003 00000003
000000CB 000000CB 00000075
7 00000140 00000140 00000050
8 * END

```

Figure 286. Example of a UPDCNTL update file using BYTE compare type

- 1 Comment line. Lists the *new* file name and the date and time of the comparison.
- 2 Comment line. Lists the *old* file name.
- 3 Header comment line. For more information about the columns, see Table 29.
- 4 First thirty-one (1E hex) bytes match.
- 5 1 byte is deleted.
- 6 (Skipping several lines). 3 bytes of the *new* file replace 3 bytes of the *old* file.
- 7 Fifty bytes inserted.
- 8 Comment line. Ends the update file.

The following table shows the column numbers used for the UPDCNTL file:

Table 29. UPDCNTL update file format using BYTE compare type

Column #	Identifier	Data Item
4-11	N-BYTE-O	<i>New</i> byte offset
13-20	O-BYTE-O	<i>Old</i> byte offset
22-29	MAT-LEN	Number of matching bytes
31-38	INS-LEN	Number of inserted bytes
40-47	DEL-LEN	Number of deleted bytes

Update long control

The process option UPDLDEL produces an update file that contains control records, matching *new* file source records, inserted *new* file source records, and deleted *old* file source records.

The UPDLDEL process option is available for the LINE compare type only.

Figure 287 shows an example of a UPDLDEL update file.

The control records are titled as follows:

- *HDR1, *HDR2, *HDR3**
Header titles and data
- *M-** Matched line sequence header
- *I-** Inserted line sequence header
- *I-RP** Inserted line sequence header for replacement lines
- *I-RF** Inserted line sequence header for reformatted lines
- *D-** Deleted line sequence header
- *D-RP** Deleted line sequence header for replacement lines
- *D-RF** Deleted line sequence header for reformatted lines

Header control records are full length records that delimit the copied file records. This allows you to quickly find changed areas. The records look like the information about a LONG listing. The two input files must both have the same fixed record length or each have a variable record length.

```

*HDR1 JLEVERIN TEST2 A 07/11/2008 14.58
*HDR2 JLEVERIN TEST1 A TYPE = UPDLDEL
*I-RF INS#= 1 N-REF#=000001 O-REF#=000001 *****ASMFSUPC CHANGE HEADER*****
This line is reformatted; the spacing in the "new" file differs. 00000100
*D-RF DEL#= 1 N-REF#=000001 O-REF#=000001 *****ASMFSUPC CHANGE HEADER*****
This line is reformatted; the spacing in the "new" file differs. 00000100
*M- MAT#= 1 N-REF#=000002 O-REF#=000002 *****ASMFSUPC CHANGE HEADER*****
This line is the same in both files. 00000200
*I-RP INS#= 1 N-REF#=000003 O-REF#=000003 *****ASMFSUPC CHANGE HEADER*****
This line differs from the text in the "old" file. 00000300
*D-RP DEL#= 1 N-REF#=000003 O-REF#=000003 *****ASMFSUPC CHANGE HEADER*****
This line differs from the text in the "new" file. 00000300
*M- MAT#= 1 N-REF#=000004 O-REF#=000004 *****ASMFSUPC CHANGE HEADER*****
This line is the same in both files. 00000400
*I- INS#= 1 N-REF#=000005 O-REF#=000004 *****ASMFSUPC CHANGE HEADER*****
This line is in the "new" file, but not in the "old". 00000500

```

Figure 287. Example of a UPDLDEL update file

Update MVS sequenced 8 file

The process option UPDMVS8 produces a file that contains both control records and *new* file source lines using sequence numbers from *old* file columns 73 to 80.

The UPDMVS8 process option is available for the LINE Compare Type only.

The format of the generated data may be suitable as input to the IEBUPDTE utility. See *MVS/DFP Utilities* for information about the contents of this file. Figure 288 shows an example of a UPDMVS8 update file created on CMS.

```

1 ./ CHANGE LIST=ALL OLD:JLEVERIN TEST1  A
2 ./ DELETE SEQ1=00000100,SEQ2=00000100
3 This line is reformatted; the spacing in the "new" file differs.      00000100
4 ./ DELETE SEQ1=00000300,SEQ2=00000300
5 This line differs from the text in the "old" file.                    00000300
6 This line is in the "new" file, but not in the "old".                00000500

```

Figure 288. Example of a UPDMVS8 update file

- 1** Control record. Lists *old* file name.
- 2** Control record. Shows record deleted at sequence number 100 on the *old* file.
- 3** Inserted line from the *new* file.
- 4** Control record. Shows record deleted at sequence number 300 on the *old* file.
- 5** Inserted line from the *new* file.
- 6** Inserted line from the *new* file.

The files to be compared must have fixed-length 80-byte records. They must also contain sequence numbers.

Update prefixed delta lines

The process option UPDPDEL produces a variable-length update file that contains header records and complete delta lines from the input files, up to a maximum of 32K bytes in each output line.

The UPDPDEL process option is available for the LINE compare type only.

Figure 289 on page 536 shows an example of a UPDPDEL update file.

Prefix codes (I for insert and D for delete) together with the line number precede lines from the input files. Sub-totals are shown before each group of flagged records:

- INS#= for the number of consecutive inserted records,
- DEL#= for the number of consecutive deleted records,
- RPL#= for the number of consecutive *pairs* of replaced records, and
- MAT#= for the number of intervening matched records.

Update files

```
1 * NEW: JLEVERIN TEST2 A 07/11/2008 12.08
2 * OLD: JLEVERIN TEST1 A
3 *ID- LINE# SOURCE LINE
4 * RPL#= 00000001
5 I - 00000001 This line is reformatted; the spacing in the "new" file differs. 00000100
6 D - 00000001 This line is reformatted; the spacing in the "new" file differs. 00000100
4 * RPL#= 00000001 MAT#= 00000001
5 I - 00000003 This line differs from the text in the "old" file 00000300
6 D - 00000003 This line differs from the text in the "new" file. 00000300
7 * INS#= 00000001 MAT#= 00000001
8 I - 00000005 This line is in the "new" file, but not in the old.
9 * END 00000500
```

Figure 289. Example of a UPDPDEL update file

The example in Figure 289 has the following lines:

- 1 Comment line. Lists the *new* file name and the date and time of the comparison.
- 2 Comment line. Lists the *old* file name.
- 3 Header comment line.
- 4 Sub-total line showing that 1 replaced *pair* of records follow.
- 5 The line that has replaced the line in the *old* file.
- 6 The line in the *old* file that has been replaced.
- 7 Sub-total line showing that 1 inserted record follows.
- 8 The line that has been inserted in the *new* file.
- 9 Comment line. Ends the update file.

Update sequenced 0 file

The process option UPDSEQ0 produces a control file that relates insertions and deletions to the relative line numbers of the *old* file. UPDSEQ0 is like UPDCMS8, but uses relative line numbers instead of sequence numbers from the *old* file.

The UPDSEQ0 process option is available for the LINE compare type only.

This update file is characterized by control statements followed by source lines from the *new* file. All UPDSEQ0 control statements are identified by the characters “./” in columns 1 and 2 of the 80-byte record, followed by one or more spaces and additional space-delimited fields. The control statements are insert (I), delete (D), replace (R), and comment (*). Control statement data does not extend beyond column 50. Figure 290 shows an example of a UPDSEQ0 update file.

```
1 ./ * NEW: JLEVERIN TEST2 A 07/11/2008 13.34
2 ./ * OLD: JLEVERIN TEST1 A
3 ./ R 00000001 00000001 $ 00000001
4 This line is reformatted; the spacing in the "new" file differs. 00000100
5 ./ R 00000003 00000003 $ 00000001
6 This line differs from the text in the "old" file. 00000300
7 ./ I 00000004 $ 00000001
8 This line is in the "new" file, but not in the "old". 00000500
```

Figure 290. Example of a UPDSEQ0 update file

- 1** Comment line. Lists the *new* file name and the date and time of the comparison.
- 2** Comment line. Lists the *old* file name.
- 3** Replacement control record. Beginning at the first record of the *old* file, replace 1 record. The numeric value after the dollar sign specifies the number of *new* file source lines that follow the control record.
- 4** Text of *new* file line to replace line 1.
- 5** Replace the third record with 1 record.
- 6** Text of *new* file line to replace line 3.
- 7** Insert control line. Insert 1 line after record 4 of *old* file.
- 8** Text of inserted line.

Update summary only files

The process option UPDSUMO produces an update file of 4 lines: *new* file name, *old* file name, column headers, and a summary totals line.

The UPDSUMO process option is available for the LINE, WORD, and BYTE compare types.

The summary totals line has a "T" in column 1. The summary statistics are located at fixed offsets in the output line. The file has a line length of 132 bytes.

Update summary only file (LINE compare type)

```

1 *   NEW:  JLEVERIN TEST2   A                               07/11/2008
2 *   OLD:  JLEVERIN TEST1   A
3 *   NEW-PROC OLD-PROC NEW-INS  OLD-DEL  TOT-CHG  TOT-RFM  FI-PROC  FI-DIFF
4 T 00000005 00000004 00000002 00000001 00000003 00000001 00000001 00000001

. . (Continuation of previous data lines) . . . . .

1 13.39
2
3 N-NOT-PD 0-NOT-PD N-DP-LNS 0-DP-LNS
4 00000000 00000000 00000000 00000000

```

Figure 291. Example of a UPDSUMO file using LINE compare type

- 1** Comment line. Lists the *new* file name and the date and time of the comparison.
- 2** Comment line. Lists the *old* file name.
- 3** Comment line. Header line. Columns are explained in Table 30 on page 538.
- 4** Totals line.

In Figure 291, the update summary file is shown in split screen mode. The bottom half of the screen shows the result of scrolling right to see the remainder of the member.

Update files

The following table shows the column numbers used to display the update information:

Table 30. UPDSUMO format using LINE compare type

Column #	Identifier	Data Item
	NEW-PROC	Number of <i>new</i> lines processed
	OLD-PROC	Number of <i>old</i> lines processed
	NEW-INS	Number of <i>new</i> line insertions
	OLD-DEL	Number of <i>old</i> line deletions
	TOT-CHG	Total number of line changes
	TOT-RFM	Total number of reformats
	FI-PROC	Total number of files/members processed
	FI-DIFF	Total number of files/members different
	N-NOT-PD	Total <i>new</i> files/members not processed
	O-NOT-PD	Total <i>old</i> files/members not processed
	N-DP-LNS	Total number of <i>new</i> "do not process" lines
	O-DP-LNS	Total number of <i>old</i> "do not process" lines

Update summary only file (WORD compare type)

```

1 * NEW: JLEVERIN TEST2 A 07/11/2008
2 * OLD: JLEVERIN TEST1 A
3 * NEW-PROC OLD-PROC NEW-INS OLD-DEL TOT-CHG FI-PROC FI-DIFF
4 T 00000049 00000037 00000013 00000001 00000013 00000001 00000001

. . (Continuation of previous data lines) . . . . .

1 13.48
2
3 N-NOT-PD O-NOT-PD
4 00000000 00000000

```

Figure 292. Example of a UPDSUMO file using WORD compare type

- 1** Comment line. Lists the *new* file name and the date and time of the comparison.
- 2** Comment line. Lists the *old* file name.
- 3** Comment line. Header line. Columns are explained in Table 31.
- 4** Totals line.

In Figure 292, the UPDSUMO file is shown in split screen mode. The bottom half of the screen is scrolled right to show the remainder of the member.

The following table shows the column numbers used to display the update information:

Table 31. UPDSUMO format using WORD compare type

Column #	Identifier	Data Item
	NEW-PROC	Number of <i>new</i> words processed

Table 31. UPDSUMO format using WORD compare type (continued)

Column #	Identifier	Data Item
	OLD-PROC	Number of <i>old</i> words processed
	NEW-INS	Number of <i>new</i> word insertions
	OLD-DEL	Number of <i>old</i> word deletions
	TOT-CHG	Total number of word changes
	FI-PROC	Total number of files/members processed
	FI-DIFF	Total number of files/members different
	N-NOT-PD	Total <i>new</i> files/members not processed
	O-NOT-PD	Total <i>old</i> files/members not processed

Update summary only file (BYTE compare type)

```

1 * NEW: JLEVERIN TEST2 A 07/11/2008
2 * OLD: JLEVERIN TEST1 A
3 * NEW-PROC OLD-PROC NEW-INS OLD-DEL TOT-CHG FI-PROC FI-DIFF
4 T 00000400 00000320 00000089 00000009 00000095 00000001 00000001

. . (Continuation of previous data lines) . . . . .

COMMAND ==> _ SCROLL ==> PAGE
1 13.51
2
3 N-NOT-PD O-NOT-PD
4 00000000 00000000

```

Figure 293. Example of a UPDSUMO file using BYTE compare type

- 1** Comment line. Lists the *new* file name and the date and time of the comparison.
- 2** Comment line. Lists the *old* file name.
- 3** Comment line. Header line. Columns are explained in Table 32.
- 4** Totals line.

In Figure 293, the UPDSUMO file is shown in split screen mode. The bottom half of the screen shows the result of scrolling right to see the remainder of the member.

The following table shows the column numbers used to display the update information:

Table 32. UPDSUMO format using BYTE compare type

Column #	Identifier	Data Item
	NEW-PROC	Number of <i>new</i> bytes processed
	OLD-PROC	Number of <i>old</i> bytes processed
	NEW-INS	Number of <i>new</i> byte insertions
	OLD-DEL	Number of <i>old</i> byte deletions
	TOT-CHG	Total number of byte changes

Update files

Table 32. UPDSUMO format using BYTE compare type (continued)

Column #	Identifier	Data Item
	FI-PROC	Total number of files/members processed
	FI-DIFF	Total number of files/members different
	N-NOT-PD	Total <i>new</i> files/members not processed
	O-NOT-PD	Total <i>old</i> files/members not processed

Appendix D. Accessibility

Accessible publications for this product are offered through the z/OS Information Center, which is available at www.ibm.com/systems/z/os/zos/bkserv/.

If you experience difficulty with the accessibility of any z/OS information, please send a detailed message to mhvrcfs@us.ibm.com or to the following mailing address:

IBM Corporation
Attention: MHVRCFS Reader Comments
Department H6MA, Building 707
2455 South Road
Poughkeepsie, NY 12601-5400
USA

Accessibility features

Accessibility features help a user who has a physical disability, such as restricted mobility or limited vision, to use software products successfully. The major accessibility features in z/OS enable users to:

- Use assistive technologies such as screen readers and screen magnifier software
- Operate specific or equivalent features using only the keyboard
- Customize display attributes such as color, contrast, and font size.

Using assistive technologies

Assistive technology products, such as screen readers, function with the user interfaces found in z/OS. Consult the assistive technology documentation for specific information when using such products to access z/OS interfaces.

Keyboard navigation of the user interface

Users can access z/OS user interfaces using TSO/E or ISPF. Refer to *z/OS TSO/E Primer*, *z/OS TSO/E User's Guide*, and *z/OS ISPF User's Guide Vol I* for information about accessing TSO/E and ISPF interfaces. These guides describe how to use TSO/E and ISPF, including the use of keyboard shortcuts or function keys (PF keys). Each guide includes the default settings for the PF keys and explains how to modify their functions.

Dotted decimal syntax diagrams

Syntax diagrams are provided in dotted decimal format for users accessing the z/OS Information Center using a screen reader. In dotted decimal format, each syntax element is written on a separate line. If two or more syntax elements are always present together (or always absent together), they can appear on the same line, because they can be considered as a single compound syntax element.

Each line starts with a dotted decimal number; for example, 3 or 3.1 or 3.1.1. To hear these numbers correctly, make sure that your screen reader is set to read out punctuation. All the syntax elements that have the same dotted decimal number (for example, all the syntax elements that have the number 3.1) are mutually

exclusive alternatives. If you hear the lines 3.1 USERID and 3.1 SYSTEMID, you know that your syntax can include either USERID or SYSTEMID, but not both.

The dotted decimal numbering level denotes the level of nesting. For example, if a syntax element with dotted decimal number 3 is followed by a series of syntax elements with dotted decimal number 3.1, all the syntax elements numbered 3.1 are subordinate to the syntax element numbered 3.

Certain words and symbols are used next to the dotted decimal numbers to add information about the syntax elements. Occasionally, these words and symbols might occur at the beginning of the element itself. For ease of identification, if the word or symbol is a part of the syntax element, it is preceded by the backslash (\) character. The * symbol can be used next to a dotted decimal number to indicate that the syntax element repeats. For example, syntax element *FILE with dotted decimal number 3 is given the format 3 * FILE. Format 3* FILE indicates that syntax element FILE repeats. Format 3* * FILE indicates that syntax element * FILE repeats.

Characters such as commas, which are used to separate a string of syntax elements, are shown in the syntax just before the items they separate. These characters can appear on the same line as each item, or on a separate line with the same dotted decimal number as the relevant items. The line can also show another symbol giving information about the syntax elements. For example, the lines 5.1*, 5.1 LASTRUN, and 5.1 DELETE mean that if you use more than one of the LASTRUN and DELETE syntax elements, the elements must be separated by a comma. If no separator is given, assume that you use a blank to separate each syntax element.

If a syntax element is preceded by the % symbol, this indicates a reference that is defined elsewhere. The string following the % symbol is the name of a syntax fragment rather than a literal. For example, the line 2.1 %OP1 means that you should refer to separate syntax fragment OP1.

The following words and symbols are used next to the dotted decimal numbers:

- ? means an optional syntax element. A dotted decimal number followed by the ? symbol indicates that all the syntax elements with a corresponding dotted decimal number, and any subordinate syntax elements, are optional. If there is only one syntax element with a dotted decimal number, the ? symbol is displayed on the same line as the syntax element, (for example 5? NOTIFY). If there is more than one syntax element with a dotted decimal number, the ? symbol is displayed on a line by itself, followed by the syntax elements that are optional. For example, if you hear the lines 5 ?, 5 NOTIFY, and 5 UPDATE, you know that syntax elements NOTIFY and UPDATE are optional; that is, you can choose one or none of them. The ? symbol is equivalent to a bypass line in a railroad diagram.
- ! means a default syntax element. A dotted decimal number followed by the ! symbol and a syntax element indicates that the syntax element is the default option for all syntax elements that share the same dotted decimal number. Only one of the syntax elements that share the same dotted decimal number can specify a ! symbol. For example, if you hear the lines 2? FILE, 2.1! (KEEP), and 2.1 (DELETE), you know that (KEEP) is the default option for the FILE keyword. In this example, if you include the FILE keyword but do not specify an option, default option KEEP will be applied. A default option also applies to the next higher dotted decimal number. In this example, if the FILE keyword is omitted, default FILE(KEEP) is used. However, if you hear the lines 2? FILE, 2.1, 2.1.1!

(KEEP), and 2.1.1 (DELETE), the default option KEEP only applies to the next higher dotted decimal number, 2.1 (which does not have an associated keyword), and does not apply to 2? FILE. Nothing is used if the keyword FILE is omitted.

- * means a syntax element that can be repeated 0 or more times. A dotted decimal number followed by the * symbol indicates that this syntax element can be used zero or more times; that is, it is optional and can be repeated. For example, if you hear the line 5.1* data area, you know that you can include one data area, more than one data area, or no data area. If you hear the lines 3*, 3 HOST, and 3 STATE, you know that you can include HOST, STATE, both together, or nothing.

Note:

1. If a dotted decimal number has an asterisk (*) next to it and there is only one item with that dotted decimal number, you can repeat that same item more than once.
 2. If a dotted decimal number has an asterisk next to it and several items have that dotted decimal number, you can use more than one item from the list, but you cannot use the items more than once each. In the previous example, you could write HOST STATE, but you could not write HOST HOST.
 3. The * symbol is equivalent to a loop-back line in a railroad syntax diagram.
- + means a syntax element that must be included one or more times. A dotted decimal number followed by the + symbol indicates that this syntax element must be included one or more times; that is, it must be included at least once and can be repeated. For example, if you hear the line 6.1+ data area, you must include at least one data area. If you hear the lines 2+, 2 HOST, and 2 STATE, you know that you must include HOST, STATE, or both. Similar to the * symbol, the + symbol can only repeat a particular item if it is the only item with that dotted decimal number. The + symbol, like the * symbol, is equivalent to a loop-back line in a railroad syntax diagram.

Notices

This information was developed for products and services offered in the U.S.A. or elsewhere.

IBM may not offer the products, services, or features discussed in this document in other countries. Consult your local IBM representative for information on the products and services currently available in your area. Any reference to an IBM product, program, or service is not intended to state or imply that only that IBM product, program, or service may be used. Any functionally equivalent product, program, or service that does not infringe any IBM intellectual property right may be used instead. However, it is the user's responsibility to evaluate and verify the operation of any non-IBM product, program, or service.

IBM may have patents or pending patent applications covering subject matter described in this document. The furnishing of this document does not give you any license to these patents. You can send license inquiries, in writing, to:

IBM Director of Licensing
IBM Corporation
North Castle Drive
Armonk, NY 10504-1785
U.S.A

For license inquiries regarding double-byte character set (DBCS) information, contact the IBM Intellectual Property Department in your country or send inquiries, in writing, to:

Intellectual Property Licensing
Legal and Intellectual Property Law
IBM Japan, Ltd.
19-21, Nihonbashi-Hakozakicho, Chuo-ku
Tokyo 103-8510, Japan

The following paragraph does not apply to the United Kingdom or any other country where such provisions are inconsistent with local law: INTERNATIONAL BUSINESS MACHINES CORPORATION PROVIDES THIS PUBLICATION "AS IS" WITHOUT WARRANTY OF ANY KIND, EITHER EXPRESS OR IMPLIED, INCLUDING, BUT NOT LIMITED TO, THE IMPLIED WARRANTIES OF NON-INFRINGEMENT, MERCHANTABILITY OR FITNESS FOR A PARTICULAR PURPOSE. Some states do not allow disclaimer of express or implied warranties in certain transactions, therefore, this statement may not apply to you.

This information could include technical inaccuracies or typographical errors. Changes are periodically made to the information herein; these changes will be incorporated in new editions of the publication. IBM may make improvements and/or changes in the product(s) and/or the program(s) described in this publication at any time without notice.

Any references in this information to non-IBM Web sites are provided for convenience only and do not in any manner serve as an endorsement of those Web sites. The materials at those Web sites are not part of the materials for this IBM product and use of those Web sites is at your own risk.

IBM may use or distribute any of the information you supply in any way it believes appropriate without incurring any obligation to you.

Licensees of this program who wish to have information about it for the purpose of enabling: (i) the exchange of information between independently created programs and other programs (including this one) and (ii) the mutual use of the information which has been exchanged, should contact:

Site Counsel
IBM Corporation
2455 South Road
Poughkeepsie, NY 12601-5400
USA

Such information may be available, subject to appropriate terms and conditions, including in some cases, payment of a fee.

The licensed program described in this information and all licensed material available for it are provided by IBM under terms of the IBM Customer Agreement, IBM International Program License Agreement, or any equivalent agreement between us.

Information concerning non-IBM products was obtained from the suppliers of those products, their published announcements or other publicly available sources. IBM has not tested those products and cannot confirm the accuracy of performance, compatibility or any other claims related to non-IBM products. Questions on the capabilities of non-IBM products should be addressed to the suppliers of those products.

All statements regarding IBM's future direction or intent are subject to change or withdrawal without notice, and represent goals and objectives only.

If you are viewing this information softcopy, the photographs and color illustrations may not appear.

COPYRIGHT LICENSE:

This information might contain sample application programs in source language, which illustrate programming techniques on various operating platforms. You may copy, modify, and distribute these sample programs in any form without payment to IBM, for the purposes of developing, using, marketing or distributing application programs conforming to the application programming interface for the operating platform for which the sample programs are written. These examples have not been thoroughly tested under all conditions. IBM, therefore, cannot guarantee or imply reliability, serviceability, or function of these programs. The sample programs are provided "AS IS", without warranty of any kind. IBM shall not be liable for any damages arising out of your use of the sample programs.

Policy for unsupported hardware

Various z/OS elements, such as DFSMS, HCD, JES2, JES3, and MVS, contain code that supports specific hardware servers or devices. In some cases, this device-related element support remains in the product even after the hardware devices pass their announced End of Service date. z/OS may continue to service element code; however, it will not provide service related to unsupported hardware devices. Software problems related to these devices will not be accepted

for service, and current service activity will cease if a problem is determined to be associated with out-of-support devices. In such cases, fixes will not be issued.

Minimum supported hardware

The minimum supported hardware for z/OS releases identified in z/OS announcements can subsequently change when service for particular servers or devices is withdrawn. Likewise, the levels of other software products supported on a particular release of z/OS are subject to the service support lifecycle of those products. Therefore, z/OS and its product publications (for example, panels, samples, messages, and product documentation) can include references to hardware and software that is no longer supported.

- For information about software support lifecycle, see: IBM Lifecycle Support for z/OS (<http://www.ibm.com/software/support/systemsz/lifecycle/>)
- For information about currently-supported IBM hardware, contact your IBM representative.

Programming Interface Information

This publication primarily documents information that is NOT intended to be used as Programming Interfaces of ISPF.

This publication also documents intended Programming Interfaces that allow the customer to write programs to obtain the services of ISPF. This information is identified where it occurs, either by an introductory statement to a chapter or section or by the following marking:

```
+-----Programming Interface information-----+
```

```
+-----End of Programming Interface information-----+
```

Trademarks

IBM, the IBM logo, and [ibm.com](http://www.ibm.com)[®] are trademarks or registered trademarks of International Business Machines Corp., registered in many jurisdictions worldwide. Other product and service names might be trademarks of IBM or other companies. A current list of IBM trademarks is available on the Web at www.ibm.com/legal/copytrade.shtml (<http://www.ibm.com/legal/copytrade.shtml>).

UNIX is a registered trademark of The Open Group in the United States and other countries.

Windows and Windows NT are trademarks of Microsoft Corporation in the United States, other countries, or both.

Trademarks

Index

Special characters

: (colon), using with function key definition 41
/ (data set name character), Data Set List utility (option 3.4) 157
* SuperC process statement 475
.IM control word 324
* SuperC process statement 475
% field, Data Set List utility 155
%Used field, VTOC Summary Information panel 162
%USED keyword, SORT command 178
> (greater than)
 using with function key definition 41
&xxxx action, ACTION column 199
= (repeat last command) line command, Data Set List utility (option 3.4) 170
= workstation command 448
"To" panel for copying 135
"To" panel for moving 137

Numerics

3850 virtual volumes
 allocating a data set to 117
5550 terminal 201

A

A (ANSI) parameter, Printer Carriage Control field 195
A (ASA printer characters) record format 119
AA (auditor auditing) line command
 z/OS UNIX Directory List Utility (option 3.17) 280
accessibility 541
 contact IBM 541
 features 541
ACCOUNT command, TSO 117
ACCOUNT, TSO 97
ACTBAR workstation command 447
Action column 198
Activate/Create Profile DS Name field, SuperCE Profile Manager panel 228
AD/Cycle C/370 compiler
 batch processing 366
 batch processing (option 5.15) 366
 foreground processing 352
 foreground processing (option 4.15) 352
Additional IBM Program Development Products panel 421
Additional Input Libraries field, Foreground Print Options panel 327
address, APPC 63
address, TCP/IP 62
AFTER parameter
 Breakpoint Primary Option Menu 419

AFTER parameter (*continued*)
 When field 415
AIX (*AIX*) entry in Volume field 143
Alias action, Action column 199
alias entries, processing 183
Alias members, searching 500
Alias members, SuperC compare 500
ALL parameter
 FIND command 87
 Function field 411
 Variable field 412
allocate action prompt workstation command 447
Allocate command 170
ALLOCATE command, TSO 116
allocate SMS workstation command 448
allocate workstation command 447
Allocation Error panel 122
allow mixed-case in action field option 198
Always save table in originating data set 249, 261
American National Standard Institute 195
APF authorized status 297, 304
APPC address
 definition 63
APPEND command
 Data Set List utility (option 3.4) 171
 parameters 171
Application ID field, Command Table Utility panel 197
ASCII 88
aspect ratio parameter for PRINTG 28
Assembler concatenation sequence 327
Assembler H (option 4.1) allocation data sets
 overview 329
Assembler H (option 5.1) 358
Assembler Options field
 Foreground Assembler H (option 4.1) 330
assistive technologies 541
Attrib display view, Initial View field 145
audit information, z/OS UNIX 297

B

B (batch) parameter, Mode field
 Search-For Utility panel 232
 SuperC Utility panel 209
B (blocked) record format, Record Format field 119
B (browse) line command
 Data Set List utility (option 3.4) 165
 z/OS UNIX Directory List Utility (option 3.17) 281
Batch (option 5)
 AD/Cycle C/370 compiler (option 5.16) 366

Batch (option 5) (*continued*)
 Assembler H (option 5.1) 358
 C/370 compiler (option 5.13) 365
 JCL generation for Assembler and Linkage Editor 358
 JCL generation for compilers 356
 Linkage Editor (option 5.7) 362
 Member Parts List (option 5.12) 365
 overview 2
 password protection, lack of 355
 PL/I optimizing compiler (option 5.5) 361
 processing sequence 354
 VS COBOL II compiler (option 5.2) 359
 VS COBOL II interactive debug (option 5.10) 364
 VS FORTRAN compiler (option 5.3) 360
 VS Pascal compiler (option 5.6) 361
Batch Assembler H panel 358
Batch Linkage Edit panel 363
Batch Member Parts List panel 365
Batch options
 ISPD TLC 366
 OS/390 C/C++ 366
BATCH parameter, Print Mode field 185
Batch PL/I Optimizing Compile panel 361
Batch Selection panel 353
Batch Selection panel with JCL generated 356
Batch VS COBOL II Compile panel 359
Batch VS FORTRAN Compile panel 360
Batch VS Pascal Compile panel 362
BEFORE parameter
 Breakpoint Primary Option Menu 419
 When field 415
Binary copy option 283, 286, 287, 290
Blank action, Action column 199
Blank lines after headings (in export report) 263
blank parameter
 Active field
 breakpoints 415
 function traces 411
 variable traces 413
 DSORG field 155
 Operation field 413
 Pool field 412
 Printer Carriage Control field 195
 Select Pack option for "To" data set field 136
 Sequence Numbers field 212
 Specify additional search strings field 232
 When field 415
BLKS parameter, Space Units field 118
BLKSZ
 field 156

BLKSZ (*continued*)
 keyword 178
 SORT command 178

Block size field, Allocate New Data Set
 panel 119

breakpoints
 defined 413
 with qualification parameter
 values 416

Breakpoints (option 7.8)
 Cancel (option C) 418
 CANCEL primary command 415
 control display 417
 D (delete) line command 415
 END primary command 415, 417
 finding a breakpoint 418
 Go (option G) 418
 I (insert) line command 415
 input errors 417
 LOCATE primary command 415
 primary command 415
 QUAL primary command 415
 qualification 417
 qualification parameter values 415
 R (repeat) line command 415
 specifying breakpoints 414
 syntax checking 417

Breakpoints panel 414

Browse
 providing Unicode support 80

BROWSE command
 BROWSE 81
 COLUMNS 82
 DISPLAY 83
 displaying after processing 81
 FIND 85
 HEX 90
 LOCATE 92
 overview 81
 parameter member 82
 RESET 92
 SUBMIT 81, 92

Browse Command - Entry Panel 82

Browse data display panel 80

Browse field, SCRIPT/VIS Processor
 panel 338

Browse hexadecimal display
 data 91
 vertical 91

Browse Mode
 Browse data display 80
 current position in data set 92
 ending Browse 81
 overview 1, 81
 selecting Browse 80
 valid logical record length 78
 valid record format 78

BROWSE Output field, SuperCE Utility
 panel 222

browse output mode 209, 222, 232, 241

Browse table command 247

browse table panel 248

Browse workstation command 447

Byte parameter, Compare Type field 220

C

C (catalog data set) line command, Data
 Set List Utility (option 3.4) 168

C (continuation) keyword, Search-For
 utility (option 3.14) 234

C or CO (copy out) line command
 z/OS UNIX Directory List Utility
 (option 3.17) 281

C/370 compiler
 batch processing (option 5.13) 365
 foreground processing (option
 4.13) 351

C/C++ for OS/390 (option 4.19) 352

CALL statement format 347

CANCEL command
 Breakpoints (option 7.8) 415
 Command Table utility (option
 3.9) 200
 Dialog Test (option 7) 378
 table utility 252
 Tables (option 7.4) 398, 400
 Traces (option 7.7) 412
 Variables (option 7.3) 389

CANCEL, Traces (option 7.7) 413

catalog workstation command 447

CATALOG, Sort command field 178

CC parameter, DISPLAY command 83

CCSID
 Unicode support in Browse 80

CCSID parameter, DISPLAY
 command 84

char parameter, DISPLAY command 83

character string 88

character string, LOCATE 379

CHARS parameter, FIND command 86

CHG operation 413

CHGNV SuperC process statement 474

CHNG parameter, Listing Type
 field 211, 220

CI (copy in) line command
 z/OS UNIX Directory List Utility
 (option 3.17) 286

Class field, Outlist Utility panel 194

Client/Server component download
 option 189

Client/Server download 191

CLIST
 error exits 370

CLIST TERMIN command procedure
 statements 370

closing a data set 81

CMD field 382

CMPBOFS SuperC process
 statement 476

CMPCOLM SuperC process
 statement 477

CMPCOLMN SuperC process
 statement 477

CMPCOLMO SuperC process
 statement 477

CMPLINE SuperC process
 statement 478

CMPSECT SuperC process
 statement 479

COBOL Interactive debug (option 4.10A)
 overview 343
 print output data sets 345

COBOL Interactive debug (option 4.10A)
 (*continued*)
 processing sequence 344
 symbolic debug data sets 345

COBOL Interactive Debug panel 344

COBOL parameter, Sequence Numbers
 field 213

col-1 and col-2 parameters, FIND
 command 86

COLHEAD SuperC process
 statement 481

COLOR
 change defaults 51

Color used to display table key
 values 249, 262

COLS parameter, DISPLAY command 84

column limitations 89

column-identification line
 defined 82
 removing with RESET command 92

COLUMNS command, Browse 82

Command (option 6)
 interrupting a TSO command, CLIST,
 or REXX exec 370
 overview 2
 restrictions for entering a CLIST or
 REXX exec 370
 Session Manager, using 370
 terminal settings 371
 TSO commands, CLISTs, and REXX
 EXECs, entering 369

command action prompt workstation
 command 447

Command field, display view
 panels 154

command line placement, specifying 24

command prefix (&), displaying
 commands after processing 81

command stacking
 specifying delimiter 30

Command Table Editing panel 198

command table line commands
 edit 200
 view 201

Command Table utility (option 3.9)
 line commands
 D (delete) 200
 I (insert) 201
 R (repeat) 201
 primary commands
 CANCEL 200
 END 200

Command Table Utility panel 197

command time limit
 z/OS UNIX directory list 314

commands
 Dialog Test 377
 displaying after processing 81
 entering long commands 367
 ISPF command shell 442
 line 2
 primary 2
 reading syntax diagrams xiv
 TSO command 440
 Workplace 447
 WS command 441

Compare Type field, SuperCE Utility panel 219

Compare types, SuperC

- Byte 220
- File 219
- Line 219
- Word 219

compress request exit 104, 168

compress workstation command 448

Cond parameter, Browse Output field 222

CONFIRM command 172

- Data Set List utility (option 3.4) 172
- parameters

 - OFF 172
 - ON 172

Confirm Delete field, Data Set List Utility panel 146

Confirm Delete panel 125

confirm member delete 146

Confirm Purge panel 126

conversion table

- copying z/OS UNIX files 283, 286, 288, 290

COPY command 169

Copy Format Selection List panel 205

copy member 112

COPY statement 324

Copy workstation command 447

Created field

- Data Set List utility 156

CREATED keyword, SORT command 178

CSECT compare, SuperC 501

CUA

- defaults

 - function key settings 448

CUA attributes workstation

- command 447

CUA attributes... 55

CUA panel element default values 55

CUA panel element values (changing) 55

CUAATTR option, Change Utility 55

CYLS parameter, Space Units field 118

D

D (DBCS) parameter, Field Type field 204

D (delete lines)

- Command Table utility (option 3.9) 200
- Data Set List utility (option 3.4) 166
- Dialog Test (option 7) 379
- Format Specification utility (option 3.11) 206
- SCRIPT/VIS (option 4.9) 341

D (delete) line command

- Breakpoints (option 7.8) 415
- Tables (option 7.4) 398, 400
- Variables (option 7.3) 389
- z/OS UNIX Directory List Utility (option 3.17) 291

DA data set organization, DSORG field 155

DASD volume 97

Data class field, Allocate New Data Set panel 117

DATA parameter

- HEX command 90

data set allocation exit 116

data set control blocks 162

Data Set download 192

Data Set Information panel

- long format 105
- long format for managed data sets 107
- short format 109
- short format for managed data sets 110

data set list primary commands

- CONFIRM 172
- EXCLUDE 172
- FIND and RFIND 173
- LOCATE 174
- MEMBER 174
- REFRESH 174
- RESET 174
- SAVE 174
- SHOWCMD 176
- SORT 177
- SRCHFOR 179
- VA,VS,VT,VV 179

Data Set List utility (option 3.4)

- data set list exit 142
- display views and panels

 - Attrib 145, 151
 - sequence of display views 145
 - Space 145, 151
 - Total 145, 152
 - Volume 145, 149

line commands

- = (repeat last command) 170
- B (browse data set) 165
- C (catalog data set) 152, 168
- D (delete data set) 166
- E (edit data set) 164
- F (free unused space) 168
- I (data set information) 167
- M (display member list) 165
- P (print data set) 167
- R (rename data set) 167
- S (information (short)) 167
- U (uncatalog data set) 168
- V (view data set) 165
- X (print index listing) 168
- Z (compress data set) 168

line commands that do not support managed data sets

- C (catalog data set) 168
- U (uncatalog data set) 168

line commands that support managed data sets

- I (data set information) 167
- R (rename data set) 167
- S (information (short)) 167
- X (print index listing) 168

list data set 175

options

- blank - display data set list 148
- P - Print data set list 160
- PV - Print VTOC information 162

Data Set List utility (option 3.4) (continued)

- options (continued)

 - V - Display VTOC information 161

primary commands

- CONFIRM 172
- FIND 173
- LOCATE 174
- RFIND 173
- SAVE 174
- SHOWCMD 176
- SORT 177

data set list utility line commands

- Allocate 170
- copy 169
- exclude data set 169
- move 168
- RefAdd 169
- reset 168
- Search-For 170
- Search-ForE 170
- SuperC 169
- SuperCE 169
- unexclude data set 169
- unexclude first data set 169
- unexclude last data set 169

Data Set List Utility panel 141

Data Set List Utility Primary Commands 171

Data Set List Utility SHOWCMD panel 177

Data Set Name field

- Foreground Member Parts List panel 349
- SuperC Submit Batch Jobs panel 215

Data set name type field, Allocate New Data Set panel 119

data set organization 155

Data Set Password 98

Data Set utility (option 3.2)

- options

 - A - Allocate new data set 114
 - blank - data set information 127
 - C - Catalog data set 122
 - D - Delete entire data set 124
 - R - Rename entire data set 123
 - S - Data set information (short) 127
 - U - Uncatalog data set 124

options that do not support managed data sets

- C - Catalog data set 122
- U - Uncatalog data set 124

options that support managed data sets

- blank - Data set information 127
- R - Rename entire data set 123
- S - Data set information (short) 127

processing with RACF

- D - Delete 126
- R - Rename 123
- R - rename entire data set (GDG) 123

DAU data set organization, DSORG field 155

DBCS considerations, SuperC 208

DBCS data, copying 283, 286, 287, 290
 DDDD format, Expiration Date field 120
 Debug command data set field 364
 Debug Options field, Foreground
 FORTRAN interactive debug (option
 4.11) 347
 default keylist for Help Panels 38
 delete action prompt workstation
 command 447
 DELETE command, TSO 146, 172
 Delete workstation command 447
 DELETE, Traces (option 7.7) 412, 413
 Delta parameter, Listing Type field 211,
 220
 Description column 200
 Description field, SCRIPT/VS Formatting
 Style panel 341
 Device Data information, z/OS
 UNIX 297
 Device field, Data Set List utility 155
 DEVICE keyword, SORT command 178
 device name parameter for PRINTG 28
 DFSMSdftp
 striped data set type 106, 110
 Dialog Function/Selection Panel,
 invoking 381
 Dialog Services (option 7.6), calling a
 dialog service 407
 dialog test
 accessing and updating variables 375
 available ISPF facilities 375
 breakpoint cancel (option C) 373
 environment 373
 ISPF log generation 375
 message displayed for severe
 errors 377
 NEWPOOL option 376
 severe error found at breakpoint 376
 Dialog Test
 DBCS value format 393
 log entry for current value of
 variable 407
 modifying a table row 397
 reasons errors occur 377
 variable usage 376
 Dialog Test (option 7)
 Breakpoints (option 7.8) 413
 commands 377
 D (delete lines) 379
 Dialog Services (option 7.6) 407
 environment 418
 exceptions to restoration when using
 Go (option G) 418
 Exit (option 7.X) 420
 Functions (option 7.1) 381
 I (insert lines) 379
 Log (option 7.5) 404
 overview 2
 Panels (option 7.2) 384
 R (repeat lines) 380
 severe error handling 376
 Traces (option 7.7) 409
 Tutorial (option 7.T) 420
 variable usage 376
 Variables (option 7.3) 387
 Dialog Test Primary Option Panel 374
 Directory blocks field, Allocate New Data
 Set panel 118
 Directory List Options panel, z/OS
 UNIX 313
 DISALLOW_WILDCARDS_IN_HLQ
 option 143
 Display Area field 260
 DISPLAY command
 Browse 83
 parameters 83, 84
 Display Directory List option, z/OS
 UNIX 271
 Display mode for export data set 262
 Display Style Options field, SCRIPT/VS
 Processor panel 338
 distributed editing 68, 99
 Document Composition Facility
 (DCF) 336
 double-byte character set (DBCS)
 column specification in dialog
 test 394
 defining data type 204
 Dialog Test variables format 391
 finding a 1-byte hexadecimal
 string 90
 Format Specification utility (option
 3.11) 201
 ISPF editor 100
 DPLINE SuperC process statement 482
 DPLINEC SuperC process statement 482
 DS1-DS4 fields
 Extended Search-For - Concatenation
 Data Set Entry panel 240
 SuperCE - Concatenation Interactive
 Entry panel 223
 DSLIST exit 142
 DSLIST workstation command 447
 Dsname Level field, Data Set List Utility
 panel 142
 Dsorg field, Data Set List utility 155
 DSORG keyword, SORT command 178
 DTEST system command 374

E

E (EBCDIC) parameter, Field Type
 field 204
 E (edit data set) line command, Data Set
 List utility (option 3.4) 164
 edit
 double-byte character set
 support 100
 Edit (option 2)
 editing a data set 95
 overview 2
 valid logical record length 95
 valid record format 95
 edit action prompt workstation
 command 447
 EDIT command, Browse 85
 Edit Entry Panel 96
 EDIT primary command
 z/OS UNIX directory list 309
 Edit table command 246, 247
 edit table panel 248
 Edit workstation command 447
 edit, command table line command 200
 edit, distributed 68, 99
 editing a member 112
 END
 Traces (option 7.7) 412, 413
 END command
 Breakpoints (option 7.8) 415, 417
 Command Table utility (option
 3.9) 200
 Dialog Test (option 7) 379
 Variables (option 7.3) 389
 Enter Session Manager Mode field 370
 Environ settings 57
 ENVIRON system command 57
 environment, Dialog Test 373
 errors
 message displayed during dialog test
 processing 377
 reasons for occurring during Dialog
 Test 377
 trigger statement 326
 Eview output mode 209, 222
 EXCLUDE command 172
 Exclude Data Set command 169
 Execution Params field
 COBOL interactive debug 345
 Exit (option 7.X) ending Dialog Test 420
 Exit (option X)
 overview 3
 EXPAND primary command 249
 Expanding Packed Data 323
 expansion trigger, defined 323
 Expiration data field, Allocate New Data
 Set panel 120
 Expires field, Data Set List utility 156
 EXPIRES keyword, SORT command 178
 explosion chain, defined 351
 EXPORT command 252
 export table to data set 265
 data set attributes 264
 export data set 254
 Export Layout panel 252
 export report options 262, 266
 EXTENDED
 data set name type 106, 110
 Extended Attributes field, Allocate New
 Data Set panel 120
 Extended Attributes information, z/OS
 UNIX 296
 extended binary coded decimal
 interchange code (EBCDIC)
 defining data type 204
 using numbered data 204
 Extended Search-For - Concatenation
 Batch Entry panel 241
 Extended Search-For - Concatenation
 Data Set Entry panel 240
 Extended Search-For Compare utility
 applications 459
 options
 B - submit batch search-for 240
 Blank - search-for strings 240
 E - edit Search-For statements data
 set 242
 P - select Search-For process
 options 242
 overview 236
 process options 461

Extended Search-For Compare utility
 (continued)
 SuperC program description 458
 utility differences 457
 Extended Search-For listing
 printing in batch mode 241
 Extended Search-For Utility panel 237
 extended utilities 457
 extension variables 249

F

F (foreground) parameter, Mode
 field 209
 F (foreground) parameter, Mode field,
 Search-For Utility panel 232
 F (free unused space) line command,
 Data Set List utility (option 3.4) 168
 F (function) pool, Pool field 412
 F record format, Record Format
 field 119
 false match, correcting in SuperC 499
 family printer type parameter for
 PRINTG 28
 FEXPORT command 254
 field 415
 Active 411, 413, 415
 AFTER 419
 Application 419
 BEFORE 419
 Breakpoint 419
 by row number 393
 BY ROW NUMBER 393
 current row 393
 Current row count 402, 404
 Current row pointer 401, 403
 Current status 419
 Cursor field 385
 Cursor position 386
 Date created 402, 403
 DBCS column specification 394
 Dialog services to be traced 411
 Display in window 386
 Function 411, 413, 415, 419
 ID 384
 KEYS 401
 LANG 382
 Last date modified 402, 404
 Last modified by 402, 404
 Last service return code 403
 Last table service 403
 Last time modified 402, 404
 Message id 385
 Message pop-up field 386
 MODE 383
 Modified row count 402, 404
 NAMES 401
 NEWAPPL 384
 NEWPOOL 384
 Number of keys 401
 Number of names 401
 Number of rows 401
 Open option 403
 Open tables 393
 Operation 413
 Original row count 402, 404
 P (pool) 389

field (continued)
 PANEL 382
 Panel name 385
 PASSLIB 384
 PGM 383
 Pool 412
 Qual 415
 Qualification parameter values 416
 Return code 419
 row identification 393
 Row number 396
 Service 415
 Service Name 419
 specifying a DBCS value 393
 Status for this screen 402, 403
 Table available 402
 table name 393
 Table name 396
 Table on disk 403
 Time created 402, 404
 Update count 402, 404
 using the Value field 393
 variable 393
 Variable 389, 397
 Virtual storage size 403, 404
 When 415
 WSCMD 384
 Field Heading field, table utility 253
 Field Length field, Format Definition
 panel 203
 Field Number field, Format Definition
 panel 203
 Field Type field, Format Definition
 panel 204
 field1 parameter, SORT command 178
 field2 parameter, SORT command 178
 FILE command, table utility 254
 File parameter, Compare Type field 219
 FILEXFER service 192
 FILTER primary command
 z/OS UNIX directory list 309
 FIND command 173
 ASCII strings 88
 Browse
 1-byte hexadecimal strings 90
 character strings, use of 88
 column limitations 89
 conditions for character string
 matches 87
 displaying column numbers
 searched 87
 omitting string delimiters 86
 picture strings, use of 88
 rules for using col-1 and col-2 89
 specifying FIND strings 86
 starting point, direction, and extent
 of search 87
 string not found actions 87
 text strings, use of 88
 using RFIN 89
 using string delimiters 86
 search operands 86, 87
 string matching operands 86
 table utility 255
 USASCII strings 88
 UTF8 strings 88

FIND primary command
 z/OS UNIX directory list 309
 FIRST parameter, FIND command 87
 Foreground (option 4)
 AD/Cycle C/370 compiler (option
 4.15) 352
 AD/Cycle C/370 compiler (option
 4.16) 352
 Assembler H (option 4.1) 329
 C/370 compiler (option 4.13) 351
 COBOL interactive debug (option
 4.10A) 343
 defined 319
 expanding packed data 323
 FORTRAN interactive debug (option
 4.11) 346
 input data sets 326
 Linkage Editor (option 4.7) 334
 list data sets 327
 Members Parts List (option 4.12) 347
 object data sets 328
 overview 2
 password protection 328
 PL/I optimizing compiler (option
 4.5) 332
 processing sequence 320
 REXX/370 compiler (option 4.14) 351
 SCRIPT/VS (option 4.9) 336
 using the TSO/E Information Center
 Facility 329
 VS COBOL II compiler (option
 4.2) 330
 VS COBOL II interactive debug
 (option 4.10) 343
 VS FORTRAN compiler (option
 4.3) 331
 VS Pascal compiler (option 4.6) 333
 Foreground Assembler H panel 330
 Foreground Environment Feature 336
 Foreground Linkage Edit panel 335
 Foreground Members Parts List
 panel 348
 Foreground Options
 C/C++ for OS/390 352
 ISPD TLC 352
 Foreground PL/I Optimizing Compile
 panel 333
 Foreground Print Options for Style
 panel 339
 Foreground Print Options panel 322,
 329
 Foreground Selection panel 319
 Foreground VS COBOL II Compile
 panel 331
 Foreground VS FORTRAN Compile
 panel 332
 Foreground VS Pascal Compile
 panel 334
 Format Definition panel 203
 Format Name field
 Format Specification panel 202
 Format Selection List panel 205
 Format Specification panel 202
 Format Specification utility (option 3.11)
 line commands
 D (deleting a format) 206
 R (renaming a format) 206

Format Specification utility (option 3.11)
(continued)

line commands (continued)

S (selecting a format) 207
U (updating a format) 207

options

A - add a new format 203
C - copy formats 204
D - delete a format 205
L or Blank - display format
list 205
U - update a format 205

primary commands

LOCATE 206
SORT 206

FORTRAN interactive debug (option
4.11) 346

FORTRAN Interactive Debug panel 347

fragments, syntax diagrams xiv

Free DSCBS field, VTOC Information

Display 162

Free Extents field, VTOC Information

Display 162

From Format field, Format Specification
panel 202

From Table field, Format Specification
panel 162, 202

FS (file system) line command

z/OS UNIX Directory List Utility
(option 3.17) 292

FSCR parameter, MODE field 383

full information workstation

command 447

function key defaults, workplace 448

function key settings, workplace 448

function keys

defining functions 39

specifying labels 39

specifying number 49

Functions (option 7.1), testing a dialog

function 381

G

Generate headings (in export report) 263

generic unit address 117

GET operation 413

global color change utility 52

global color change workstation

command 447

global GUI color change utility 53

graphics interface mode, effect on Session
Manager 320

graphics, settings parameters for

PRINTG 28

Groups For Primary Members field

Foreground Member Parts List

panel 349

Member Parts List Display 351

GUI Installation, ISPF C/S Install

Utility 189

GUI parameters, specifying 59

H

Hardcopy utility (option 3.6)

additional batch printing

information 187

using the TSO/E Information Center

Facility 187

Hardcopy Utility panel

after JCL generation 186

before JCL generation 184

with the TSO/E Information Center

Facility installed 188

HELP command

displaying column numbers

searched 87

HEX command

Browse 90

operands

DATA 90

OFF 90

ON 90

VERT 90

hexadecimal data, Dialog Test variables

format 391

HFS

data set name type 106, 110

high-level qualifier

wildcards in 143

I

I (data set information) line command,

Data Set List utility (option 3.4) 167

I (implicit) variable, P (pool) field 389

I (information) line command

z/OS UNIX Directory List Utility

(option 3.17) 294

I (insert lines), Dialog Test (option

7) 379

I (insert) line command

Breakpoints (option 7.8) 415

Tables (option 7.4) 398, 400

Variables (option 7.3) 389

I (insert) line command, Command Table

utility (option 3.9) 201

IBM Products (option 9)

overview 2

IEBCOPY utility 104, 168

IEBGENER utility 187

If Partitioned, Replace Like-Named

Members field 135

If Sequential, "To" Data Set Disposition

field 136

image path 67

implicit variable 389

import table from data set 265

Include Additional Qualifiers (in data set
list) 146

INCLUDE statement 324

inconsistent attributes, defined 122

information action prompt workstation

command 447

Information Center Facility

foreground processing sequence 322

Hardcopy utility 184

Outlist utility 195

Initial Macro field, Edit Entry panel 79

Initial View field

defined 144

views

Attrib 145

sequence of views 144

Space 145

Total 145

Volume 145

input data sets 326

INSERT command 255

INSERT, Traces (option 7.7) 412, 413

Installation

Download Data Set to

Workstation 189

installation exits

compress request 104, 168

data set allocation 116

data set list (DSLIS) 142

print utility 184, 195, 322

Installation program

Workstation agent 192

integration program, workstation

tool 68

Intensity used to display table key

values 249, 262

IS data set organization, DSORG

field 155

ISPCMDS 196

ISPD TLC (option 4.18) 352

ISPD TLC compile, batch 366

ISPD TLC interface panel 352

ISPF

default keylist 38

restrictions

multivolume data sets 117, 142

tape 117, 163

ISPF C/S download 191

ISPF C/S download utility

C/S method 191

ISPF C/S Install option 189

ISPF C/S Install Utility

ISPFINST.EXE 192

ISPF C/S Installation 189

ISPF Command field 367

ISPF command shell 442

ISPF Command Shell panel 367

ISPF command shell workstation

command 447

ISPF command table workstation

command 447

ISPF Primary Option Menu - status

area 5

ISPF referral list

Workplace (Option 11) 427

ISPF restrictions

multivolume data sets 117, 142

tape 117, 163

ISPF Settings (option 0), overview 1

ISPF Table Utility 243

ISPFINST.EXE 192

ISPTLIB 196

ISRFORM table 204

ISRLEMIX

description 324

member parts list 347

return codes 326

ISRSCAN
 description 324
 member parts list 357
 return codes 326
 ISU data set organization, DSORG
 field 155

J

JCL generation
 Assembler and Linkage Editor 358
 compilers 356
 job control language, generating and
 submitting print jobs 185
 job statement information
 preventing JES line counting 340
 job stream, submitting a 81, 92
 JobID field, Outlist Utility panel 194
 Jobname field, Outlist Utility panel 194
 jump function, from leader dots 26

K

K (key) variable 395, 397, 399
 KB parameter, Space Units field 118
 keyboard
 navigation 541
 PF keys 541
 shortcut keys 541
 keylist
 defaults for Help Panels 38
 help panel name 46
 modification choices 44
 keylist utility 38
 keylist workstation command 447
 keys 38
 PA1 370
 Reset 370
 keywords, syntax diagrams xiv

L

L (List) line command
 z/OS UNIX Directory List Utility
 (option 3.17) 299
 label fields
 defining 41
 using PFSHOW command 41
 label parameter, LOCATE command 92
 Language field, Foreground Member
 Parts List panel 348
 LARGE
 data set name type 106, 110
 large files, partitioning and processing in
 SuperC 500
 Largest field, VTOC Information
 Display 162
 LAST parameter, FIND command 87
 LC command 173
 LC command, Data Set List utility
 (option 3.4) 173
 leader dots, and jump function 26
 LEFT primary command
 z/OS UNIX directory list 310

Library utility (option 3.1)
 options
 B - browse member 111
 Blank - display member list 103
 C - compress data set 103
 D - delete member 112
 E - edit member 112
 I - data set information 104
 L - print entire data set 104
 P - print member 112
 R - rename member 112
 S - data set information
 (short) 108
 V - view member 113
 X - print index listing 104
 options that support managed data
 sets
 I - data set information 107
 S - data set information
 (short) 110
 X - print index listing 104
 Library Utility panel 102
 LINE - Dialog Test (option 7) 379
 Line Cmd field, SCRIPT/VS Formatting
 Style panel 341
 line command prefix characters
 z/OS UNIX directory list 278
 line commands
 Command Table utility (option
 3.9) 200
 Data Set List utility (option 3.4) 156,
 162
 defined 2
 Format Specification utility (option
 3.11) 207
 SCRIPT/VS (option 4.9) 341
 Line parameter, Compare Type field 219
 LINE parameter, DISPLAY command 84
 LINE parameter, MODE field 383
 line-number operand, LOCATE
 command 92
 Linkage Editor (option 4.7)
 concatenation sequence 336
 LEL control statements 336
 overview 334
 Linkage Editor (option 5.7) 362
 Linkage Editor concatenation
 sequence 336
 Linkage Editor language 336
 Linkage Editor Options field, Foreground
 Linkage Editor (option 4.7) 335
 list action prompt workstation
 command 447
 list data set
 list-id 175
 prefix 175
 specifying characteristics 35
 specifying defaults 32
 List ID field
 Batch Selection Panel 355
 Foreground Print Options panel 327
 Foreground Selection panel 321
 list view workstation command 447
 list-id parameter
 SAVE command 175

Listing DS Name field
 Extended Search-For Utility
 panel 239
 SuperC Utility-Old Data Set Name
 panel 212
 Listing Dsn field, SuperCE Utility
 panel 220
 Listing DSNNAME field, Search-For Utility
 panel 232
 listing file examples
 DLMDUP listing 513
 group FILE compare 515
 LOCS listing 516
 NARROW listing 512, 513
 side-by-side listing 512, 514
 WIDE listing 514
 Listing Type field
 SuperC Utility-Old Data Set Name
 panel 211
 SuperCE Utility panel 220
 LNCT SuperC process statement 485
 load module library display
 expanded line command field 166
 Local parameter, Print Mode field 185
 Local Printer ID field, Hardcopy Utility
 panel 185
 LOCATE
 Dialog Test (option 7) 379
 Traces (option 7.7) 412, 413
 LOCATE character string 379
 LOCATE command 174
 Breakpoints (option 7.8) 415
 Browse 92
 Data Set List utility (option 3.4) 174
 Format Specification utility (option
 3.11) 206
 parameters
 label 92
 line-number 92
 lparm 174
 name 206
 Variables (option 7.3) 389
 LOCATE primary command
 z/OS UNIX directory list 310
 Locate table command 246, 248
 locate workstation command 447
 Log (option 7.5)
 displaying the ISPF log 404
 logged trace output 405
 reasons log is not available 405
 log data set
 specifying defaults 32
 Log/List (option 0)
 changing defaults 3
 long message
 line placement 26
 specifying 26
 long message areas, displaying in a
 pop-up 26
 LONG parameter, Listing Type field 211,
 220
 lowercase, defining parameters in 198
 lparm parameter, LOCATE
 command 174
 LPSFV SuperC process statement 486
 Lrecl field, Data Set List utility 156
 LRECL keyword, SORT command 178

LSTCOLM SuperC process
statement 486

M

M (display member list) line command,
Data Set List utility (option 3.4) 165
M (machine) parameter, Printer Carriage
Control field 195
M (mixed) parameter, Field Type
field 204
M record format, Record Format
field 119
MA (modify ACL) line command
z/OS UNIX Directory List Utility
(option 3.17) 299
managed data set
displaying information for 107
Management class field, Allocate New
Data Set panel 116
matching input files, SuperC 498
Maximum rows searched to determine
column width 249, 261
MB parameter, Space Units field 118
member
copy from z/OS UNIX file 282
copy to z/OS UNIX file 286
MEMBER command
description 174
member expansion return codes 326
member list display
expanded line command field 166
Member list workstation command 447
member not found 351
member parameter
BROWSE command 82
SYSTEM DD statement 358
Member Parts List (option 4.12)
CALL statement format 347
member not found 351
options
1 - browse/print member parts
list 349
2 - write member parts data
set 350
overview 347
Procedure Division 348
record format 350
Member Parts List (option 5.12) 365
member parts list display 350
membered PDS, defined 210
Message field, display view panels 154
MESSAGE keyword, SORT
command 178
MF (modify format) line command
z/OS UNIX Directory List Utility
(option 3.17) 300
MG (modify group) line command
z/OS UNIX Directory List Utility
(option 3.17) 301
mixed case, defining parameters in 198
mixed data
B (browse data set) line
command 165
defining data type 204
E (edit data set) line command 164
using numbered data 204

mixed data (*continued*)
V (view data set) line command 165
Mixed Mode 98
MM (modify mode) line command
z/OS UNIX Directory List Utility
(option 3.17) 302
MO (modify owner) line command
z/OS UNIX Directory List Utility
(option 3.17) 303
Mod parameter, "To" Data Set
Disposition field 136
Mode field
Search-For Utility panel 232
SuperC Utility panel 209
mode fields information, z/OS
UNIX 296
Mode, Mixed 98
MOUNT authority 117
MOVE command 168
move member 112
Move workstation command 447
move/copy 444
Move/Copy utility (option 3.3)
alias entries 139
options
C and CP - copying data sets 134
M and MP - moving data
sets 136
with load modules 137
Move/Copy Utility panel 133
Multiple Search Strings panel 233
multiple search strings, entering 233
multivol indicator 155
multivolume data sets 117, 142
MVOL, Sort command field 178
MX (modify extended attributes) line
command
z/OS UNIX Directory List Utility
(option 3.17) 303

N

N (new) line command
z/OS UNIX Directory List Utility
(option 3.17) 304
Name field
display view panels 154
NAME keyword
LOCATE command 206
SORT command 178, 206
name, Writer 185
navigation
keyboard 541
NCHGT SuperC process statement 474
new data set, defined for SuperC
description 207
used with SuperCE 217
New DS Name field, SuperCE Utility
panel 218
New Output Class field, Outlist Utility
panel 194
New UserID field, Reset ISPF Statistics
panel 181
New Version Number field, Reset ISPF
Statistics panel 181
NEWAPPL field 384
NEWPOOL field 384

NEXCLUDE SuperC process
statement 484
NEXT parameter, FIND command 87
NFOCUS SuperC process statement 484
NO parameter
Active field
breakpoints 415
function traces 411
variable traces 413
Browse Output field 222
Confirm Delete Request field,
deselect 146
Replace like-named PDS members
field 135
Select pack option For "To" data set
field 136
Specify additional search strings field,
deselect 232
Table available field 402
Table on disk field 403
NOACTBAR workstation command 447
NOCC parameter, DISPLAY
command 83
Nolist parameter, Listing Type field 212,
220
NOP action, ACTION column 199
NOSEQ parameter, Sequence Numbers
field 213
NOT OPEN parameter 402, 403
Notices 545
NOWRITE parameter 403
NTITLE SuperC process statement 490
Number of Copies field, Hardcopy Utility
panel 188
NY2AGE SuperC process statement 491
NY2C SuperC process statement 492
NY2D SuperC process statement 492
NY2P SuperC process statement 492
NY2Z SuperC process statement 492

O

object data sets 328
Object field
Foreground VS FORTRAN compiler
(option 4.3) 332
OBROWSE command
browsing z/OS UNIX regular
file 281
OCHGT SuperC process statement 474
OEDIT command
editing ASCII file 291
editing UTF8 file 292
editing z/OS UNIX regular file 291,
309
OEXCLUDE SuperC process
statement 484
OFF parameter
CONFIRM command 172
HEX command 90
SHOWCMD command 176
OFOCUS SuperC process statement 484
OGET command
copying z/OS UNIX file to a data
set 282
copying z/OS UNIX file to PDS
member 284

Old DS Name field, SuperCE Utility panel 218

Old parameter, "To" Data Set Disposition file 136

ON parameter
 CONFIRM command 172
 HEX command 90
 SHOWCMD command 176

Open option field
 NOWRITE parameter 403
 SHR NOWRITE parameter 403
 SHR WRITE parameter 403
 WRITE parameter 403

OPEN parameter 402, 403

Open table in SHARE mode 261

Open workstation command 447

OPT field 382

option
 Cancel (option C) 418
 Go (option G) 418

option selection
 0 - ISPF Settings 1
 1 - View 1
 10 - SCLM 2
 2 - Edit 2
 3 - Utilities 2
 4 - Foreground 2
 5 - Batch 2
 6 - Command 2
 7 - Dialog Test 2
 9 - IBM Products 2
 X - Exit 3

Options pull-down menu, switching UIDs 317

options, table utility 261

OPUT command
 copying member to z/OS UNIX file 288

Order field, table utility 253, 257

OS/390 C/C++ compile, batch 366

Other field
 Batch Assembler H (option 5.1) 359
 Batch Linkage Editor (option 5.7) 363
 Batch VS COBOL II compiler (option 5.2) 360
 Batch VS FORTRAN compiler (option 5.3) 360
 Foreground PL/I optimizing compiler (option 4.5) 333
 Foreground VS COBOL II compiler (option 4.2) 331
 Foreground VS FORTRAN compiler (option 4.3) 332
 Foreground VS Pascal compiler (option 4.6) 334

OTITLE SuperC process statement 490

OUTDD DD field, SuperC Submit Batch Jobs panel 216

Outlist utility (option 3.8)
 options
 Blank - display job output 196
 D - delete job output from SYSOUT hold queue 195
 L - list job names/IDs via the TSO STATUS command 195
 P - print job output and delete from SYSOUT hold queue 195

Outlist utility (option 3.8) (*continued*)
 options (*continued*)
 R - requeue job output to a new output class 196

Outlist Utility panel 194

overview of ISPF
 ISPF primary options 1

OVSUM parameter, Listing Type field 212, 220

owner information, z/OS UNIX 296, 299

OY2AGE SuperC process statement 491

OY2C SuperC process statement 492

OY2D SuperC process statement 492

OY2P SuperC process statement 492

OY2Z SuperC process statement 492

P

P (print) line command
 Data Set List utility (option 3.4) 167

P (profile) pool, Pool field 412

P (profile) variable, P (pool) field 389

PA1 key 370

packed data
 defined 323

packing data, Foreground (option 4) 320

pad characters for panel input fields 30

panel
 Add Row 399
 Breakpoint Primary Option 417
 confirm table row delete 396
 Dialog Test Tutorial 420
 Display 385
 display row 395
 Function Traces 411
 Invoke Dialog Service 407
 Message Display 387
 modify row 397
 Special Display 409
 Table Structure 401
 Traces 410
 Variable Traces 412
 Variables 388

panels
 data set list display view panels
 ATTRIB view panel 151
 Space view panel 151
 Total view panel 152
 VOLUME view panel 149
 load module library display
 expanded line command field 166
 member list display
 expanded line command field 166
 Tables 392
 working with dialog tables 392

Panels (option 7.2), testing dialog panels 384

parameter
 parenthesis added to 199
 parameter string 417
 parenthesis, added to command parameter 199

PARM field 383

partitioned data set
 copy from files in z/OS UNIX directory 283

partitioned data set (*continued*)
 copy to files in z/OS UNIX directory 288

partitioning and processing in SuperC, large files 500

PASSLIB field 384

Passthru action
 Action column 199

Password field
 Foreground Data Entry panel 328
 Foreground Selection panel 321

password protection 328

Password, Data Set 98

PATH (*PATH*) entry in Volume field 143

path name substitution character
 z/OS UNIX directory list 314

patterns
 Dsname Level field 142

PDS Member List field
 defined 219
 parameters 237

permissions, display in octal format 315

personal data set lists command 447

personal library lists command 447

Pgm Control status 297, 304

physical record length, defined 119

picture strings, use of 88

PL/I optimizing compiler
 batch (option 5.5) 361
 foreground (option 4.5) 332

PO data set organization, DSORG field 155

point and shoot workstation
 command 448

POU data set organization, Dsorg field 155

prefix parameter
 data set list to ISPF list data set 175
 FIND command 86
 SYSTEM DD statement 358

PREFIX parameter, FIND command 86

PREV parameter, FIND command 87

primary commands
 Browse 81
 CANCEL 378
 Command Table utility (option 3.9) 200
 Data Set List utility (option 3.4) 171
 defined 2
 END 379
 Format Specification utility (option 3.11) 206
 LOCATE 379
 QUAL 379
 RESUME 379
 SU 318

Primary Commands, Data Set List Utility 171

primary library, defined 351

primary member, defined 351

Primary quantity field, Allocate New Data Set panel 118

print action prompt workstation
 command 448

print data set command 447

print data set index workstation
 command 448

Print data set list workstation
 command 448

Print Directory List option, z/OS
 UNIX 279

Print ID field, COBOL Interactive Debug
 panel 344, 345

Print Mode field
 parameters
 BATCH parameter 185
 LOCAL parameter 185
 SCRIPT/VS Processor panel 339

print output data sets 345

print utility exit
 foreground processing sequence 322
 Hardcopy utility 184
 Outlist utility 195

Print VTOC information workstation
 command 448

Print workstation command 447

Printer Carriage Control field, Outlist
 Utility panel 195

Printer Format field, Hardcopy Utility
 panel 188

Printer Location field, Hardcopy Utility
 panel 188

PRINTG
 parameters 28
 specifying printer output 28

printing
 output 184
 SuperCE listing in batch mode 224

Procedure Division 348

Process Options field
 Extended Search-For Utility
 panel 239
 SuperCE Utility panel 221

Profile DSN field, SuperC Utility
 panel 208

Profile Name field, Edit Entry Panel 79

profile, defined for SuperCE 209

Prog ID field, COBOL Interactive Debug
 panel 344

PROMPT, Sort command field 178

PS data set organization, DSORG
 field 155

PS-E 155

PS-L 155

PSU data set organization, Dsorg
 field 155

Purge Data Set field, Confirm Purge
 panel 126

PUT operation 413

Q

QUAL
 command - Breakpoints (option
 7.8) 415
 Dialog Test (option 7) 379

qualification parameter values
 Qualify action bar pull-down
 Breakpoints... choice 415
 Qualifications... choice 415

R

R - Rename entire data set (Data set
 utility options) 123

R (rename) line command
 Data Set List utility (option 3.4) 167
 Format Specification utility (option
 3.11) 206
 z/OS UNIX Directory List Utility
 (option 3.17) 305

R (repeat lines), Dialog Test (option
 7) 380

R (repeat) line command
 Breakpoints (option 7.8) 415
 Command Table utility 201
 Tables (option 7.4) 398, 400

RA (add to personal data set list) line
 command
 z/OS UNIX Directory List Utility
 (option 3.17) 306

RACE, processing with
 D - delete 126
 R - rename 123

Recfm field, Data Set List utility 156

RECFM keyword, SORT command 178

Record format field, Allocate New Data
 Set panel 119

Record length field, Allocate New Data
 Set panel 119

RefAdd command 169

Referred field, Data Set List utility 156

REFERRED keyword, SORT
 command 178

REFRESH command 174

REFRESH primary command
 z/OS UNIX directory list 311

rename 445

rename action prompt workstation
 command 448

rename data set with expiration
 date 124

rename processing with RACF 123

rename workstation command 447

Rename workstation command 448

renaming data sets
 with expiration date 124

REPEAT, Traces (option 7.7) 412, 413

repeatable items, syntax diagrams xiv

reset action prompt workstation
 command 447

RESET command 168, 174
 Browse 92

Reset ISPF Statistics panel 180

Reset ISPF Statistics utility (option 3.5)
 options
 D - delete ISPF statistics 183
 R - reset (create/update) ISPF
 statistics 182
 results of resetting statistics 183
 valid logical record lengths 180

RESET key
 restriction 41

reset member 112

Reset Mod Level option, Reset ISPF
 Statistics panel 181

RESET parameter, DISPLAY
 command 84

RESET primary command
 z/OS UNIX directory list 311

Reset Seq Numbers option, Reset ISPF
 Statistics panel 181

reset statistics 440

restrictions on member expansion and
 member parts lists
 all programming languages 324
 assembler 325
 COBOL 325
 FORTRAN 325
 Pascal 325
 PL/I 325
 SCRIPT/VS 326

RESUME - Dialog Test (option 7) 379

return codes
 Batch JCL generation 326, 357
 member expansion 326

REVREF SuperC process statement 486

REXX error exits 370

REXX/370 compiler
 batch processing 365
 foreground processing 351

RFIND command 173
 Data Set List utility (option 3.4) 173
 table utility 256
 using 89

RFIND primary command
 z/OS UNIX directory list 309

RIGHT primary command
 z/OS UNIX directory list 311

Rnn parameter 415

rules
 for substituting slash (/) for data set
 name 157
 for using the col-1 and col-2
 operands 89
 service call image for function trace
 entries 406
 using the add row option 399
 using the Dialog Test Breakpoints
 option 417
 using the Modify Row option 397

Run method 308

S

S (information (short)) line command,
 Data Set List utility (option 3.4) 167

S (select) line command
 Format Specification utility (option
 3.11) 207
 SCRIPT/VS (option 4.9) 341

S (shared) pool, Pool field 412

S (shared) variable, P (pool) field 389

S record format, Record Format
 field 119

SAVE command 174
 Data Set List utility (option 3.4) 174
 parameters
 list-id 175
 name 207
 table utility 256

SAVE primary command
 z/OS UNIX directory list 311

SCLM (option 10)
 overview 2, 423

SCLM Primary Option Menu 423
SCLM Setting 136
SCLM Settings 181
screen format, specifying 27
SCRIPT/VS (option 4.9) 337
 changing style options 341
 line commands
 D (delete) 341
 S (select) 341
 selecting a formatting style 340
 using the TSO/E Information Center Facility 342, 343
SCRIPT/VS Options for Style panel 342
SCRIPT/VS Processor panel 337
scrollable fields, in Table Utility 252
Scrollable fields, in Table Utility 249
Search DS Name field, Extended
 Search-For Utility panel 237
Search Member List panel 235
search process options
 ALLMEMS 462
 ANYC 463
 APNDLST 463
 ASCII 463
 COBOL 464
 CPnnnnn 464
 DPACMT 464
 DPADCMT 464
 DPBLKCL 465
 DPCBCMT 465
 DPCPCMT 465
 DPFTCMT 465
 DPMACMT 465
 DPPLCMT 465
 DPPSCMT 465
 FINDALL 465
 IDPFIX 466, 522
 LMCSFC 466
 LMTO 466, 519, 524
 LNFMT0 466
 LONGLN 467
 LPSF 467, 525
 LTO 467, 524
 MIXED 467
 NOPRTCC 467
 NOSEQ 468
 NOSUMS 468
 SEQ 468
 XREF 471, 520, 523, 524
Search String field, Search-For Utility panel 231
search strings, multiple 233
Search-For command 170
Search-For Process Statements panel 243
Search-For Utility - Submit Batch Jobs panel 236
Search-For utility (option 3.14)
 applications 459
 invoking directly 501
 selecting members from a member list 235
 SuperC program description 458
 utility differences 457
Search-For Utility panel 231
Search-ForE command 170
SearchFor extended workstation command 448
SearchFor workstation command 448
Secondary quantity field, Allocate New Data Set panel 118
Select action, Action column 199
SELECT command
 Format Specification utility (option 3.11) 207
Select SCRIPT/VS Formatting Style panel 341
SELECT service 374
SELECT SuperC process statement 489
select workstation command 448
sending comments to IBM xxi
SEQ parameter, Sequence Numbers field 212
Sequence field, table utility 257
Sequence Numbers field, SuperC Utility - Old Data Set Name panel 212
sequential data set
 copy from z/OS UNIX file 282
 copy to z/OS UNIX file 286
Serial, Volume 97
Session Manager
 Command (option 6) 370
 Foreground (option 4) 320
 Member Parts List (option 4.12) 349
 SCRIPT/VS 338
 using 370
Set options for IMPORT format report 263
SETGID bit 296, 302
Settings option 23
Settings workstation command 448
SETUID bit 296, 302
SETVERB action
 Action column 199
shared library status 297, 304
shared profile settings 58
shift-in characters
 in Dialog Test variables 391
 using the Value field 393
shift-out characters
 in Dialog Test variables 391
 using the Value field 393
short information command 448
shortcut keys 541
SHOWCMD command 176
 Data Set List utility (option 3.4) 176
 parameters
 OFF 176
 ON 176
SHR NOWRITE parameter 403
SHR WRITE parameter 403
SHRPROF system command 58
Size field
 VTOC Information Display 162
SLIST SuperC process statement 490
smart action 452
Software Configuration and Library Manager (SCLM) 423
SORT command 177
 Data Set List utility (option 3.4) 177
 Format Specification utility (option 3.11) 206
 keywords
 %USED 178
 BLKSZ 178
 SORT command (*continued*)
 keywords (*continued*)
 CREATED 178
 DEVICE 178
 DSORG 178
 EXPIRES 178
 LRECL 178
 MESSAGE 178
 NAME 178
 RECFM 178
 REFERRED 178
 TRACKS 178
 VOLUME 178
 XT 178
 parameters
 field1 178
 field2 178
 NAME 206
 TIME 206
 table utility 256
SORT primary command
 z/OS UNIX directory list 312
Source Data Online field, Batch Selection panel 354
Source Data Packed field
 Batch Selection panel 354
 Foreground Print Options panel 323
 Foreground Selection panel 320
Source field, COBOL Interactive Debug panel 345
Source Type field, Foreground Selection panel 321
Space display view, Initial View field 145
Space units field, Allocate New Data Set panel 118
Specify additional strings field, Search-For Utility panel 232
Specify Pack option for "To" Data Set field 136
split-screen mode
 command line placement 25
SRCHFOR command, Data Set List utility (option 3.4) 179
SRCHFOR SuperC process statement 487
SRCHFORC SuperC process statement 487
standard Search-For utility, entering multiple search strings 233
standard utilities 457
Start Column field 203
starting a GUI session
 from Settings (option 0) 61
Statements Dsn field
 Extended Search-For Utility panel 239
 SuperCE Utility panel 221
statistics
 creating or resetting 182
STATS command 257
status area - ISPF Primary Option Menu 5
status area - Primary Option Menu calendar view 10
 Defining 13
 function key view 9

- status area - Primary Option Menu
 - (continued)
 - No view selected 13
 - point-and-shoot view 12
 - session view 6
 - user view 12
- Status for Table panel
 - table not open 402
 - table open 403
- sticky bit 296, 302
- Storage class field, Allocate New Data Set panel 116
- string parameter
 - FIND command 86
- STRUCT command 259
- Style field
 - SCRIPT/VS Formatting Style panel 341
 - SCRIPT/VS Processor panel 337
- style, defined for SCRIPT/VS 337
- SU primary command 318
 - z/OS UNIX directory list 313
- SUBMIT command, BROWSE 81, 92
- Submit workstation command 447
- submitting a job stream 81, 92
- suffix
 - add to file name 289
 - strip from file name 285
- SUFFIX parameter, FIND command 88
- SuperC
 - CSECT compare 501
- SuperC Activate/Create Profile options
 - A - activate 228
 - C - create 228
 - D - default 229
- SuperC alias members 500
- SuperC CLIST interface 229
- SuperC command 169
- SuperC compare types
 - Byte 220
 - File 219
 - Line 219
 - Word 219
- SuperC Compare utility
 - correcting false matches 499
 - filtering priority for input lines 497
 - find match example 498
 - invoking directly 501
 - partitioning and processing large files 500
- SuperC comparison listing
 - I (change bar) 508
 - change bar (I) 508
 - column title line 506
 - D (deleted line) 507
 - DC (delete compose) 508
 - DEL= (delete TYPE code) 508
 - delete compose (DC) 508
 - delete moved (DM) 508
 - delete replace (DR) 507
 - deleted line (I) 507
 - DLMDUP listing example 513
 - DM (delete moved) 508
 - DMR= (delete-move-reformat TYPE code) 508
 - DMV= (delete-move TYPE code) 508
 - DR (delete replace) 507
- SuperC comparison listing (continued)
 - FILE compare of file groups 515
 - I (inserted line) 507
 - IC (insert compose) 508
 - id column 506
 - ID column 506
 - ID column (listing file) 506
 - IM (insert moved) 508
 - IMR= (insert-move-reformat TYPE code) 508
 - IMV= (insert-move TYPE code) 508
 - INS= (insert TYPE code) 508
 - insert compose (IC) 508
 - insert moved (IM) 508
 - inserted line (I) 507
 - LEN column 506
 - LEN column (listing file) 506
 - LOCS listing example 516
 - MAT= (match TYPE code) 508
 - match compose (MC) 507
 - MC (match compose) 507
 - member summary section 505
 - N-LN# 506, 507
 - N-LN# (listing file) 506, 507
 - NARROW listing example 512, 513
 - O-LN# 506, 507
 - O-LN# (listing file) 506, 507
 - overall summary section 505
 - page headings
 - compare date 506
 - compare time 506
 - new file ID 506
 - old file ID 506
 - page number 506
 - printer control character 506
 - program date 506
 - program ID 506
 - program version 506
 - reformat new (RN) 507
 - reformat old (RO) 507
 - RFM= (reformat TYPE code) 508
 - RN (reformat new) 507
 - RO (reformat old) 507
 - RPL= (replace TYPE code) 508
 - scale 507
 - section title line 506
 - side-by-side listing example 512, 514
 - source line column 506
 - SOURCE LINE column 506
 - SOURCE LINE column (listing file) 506
 - TYPE column 506
 - TYPE column (listing file) 506
 - WIDE listing example 514
- SuperC comparison process statements
 - .* 475
 - * 475
 - CHNGV 474
 - CMPBOFS 476
 - CMPCOLM 477
 - CMPCOLMN 477
 - CMPCOLMO 477
 - CMPLINE 478
 - CMPSECT 479
 - COLHEAD 481
 - DPLINE 482
 - DPLINEC 482
- SuperC comparison process statements (continued)
 - LNCT 485
 - LSTCOLM 486
 - NCHGT 474
 - NEXCLUDE 484
 - NFOCUS 484
 - NTITLE 490, 506
 - NY2AGE 491
 - NY2C 492
 - NY2D 492
 - NY2P 492
 - NY2Z 492
 - OCHGT 474
 - OEXCLUDE 484
 - OFOCUS 484
 - OTITLE 490, 506
 - OY2AGE 491
 - OY2C 492
 - OY2D 492
 - OY2P 492
 - OY2Z 492
 - REVPREF 486
 - SELECT 489
 - SELECTF 515
 - SLIST 490
 - WORKSIZE 491
 - Y2PAST 494
- SuperC comparison type
 - LINE 506
 - WORD 517
- SuperC Defaults panel 230
- SuperC extended workstation command 448
- SuperC listing type
 - DELTA 506
 - UPDCMS8 529
 - UPDCNTL 530
 - UPDLDEL 534
 - UPDMVS8 534
 - UPDPDEL 535
 - UPDREV 528
 - UPDREV2 529
 - UPDSEQ0 536
 - UPDSUMO 537
- SuperC listing types
 - CHNG 211, 220
 - Delta 211, 220
 - Long 211, 220
 - Nolist 212, 220
 - OVSUM 212, 220
- SuperC listings 505
- SuperC load module compares 501
- SuperC Member List panel 213
- SuperC process options
 - ALLMEMS 462
 - ANYC 463
 - APNDLST 463
 - APNDUPD 463
 - ASCII 463
 - CKPACKL 463
 - CNPML 464
 - COBOL 464
 - COVSUM 464
 - CPnnnnn 464
 - DLMDUP 464, 513
 - DLREFM 464

SuperC process options (*continued*)

DPACMT 464
 DPADCMT 464
 DPBLKCL 465
 DPCBCMT 465
 DPCPCMT 465
 DPFTCMT 465
 DPMACMT 465
 DPPLCMT 465
 DPPSCMT 465
 FINDALL 465
 FMSTOP 466
 FMVLNS 466, 508
 GWCBL 466, 508
 LOCS 467, 516
 LONGLN 467
 NARROW 467, 512, 513
 NOPRTCC 467, 506, 517
 NOSEQ 468
 NOSUMS 468
 REFMOVR 468
 SDUPM 468
 SEQ 468
 SYSIN 468
 UPDCMS8 468
 UPDCNTL 468
 UPDLDEL 469
 UPDMVS8 469
 UPDPDEL 469
 UPDREV 469
 UPDREV2 470
 UPDSEQ0 470
 UPDSUMO 470
 VTITLE 471
 WIDE 471, 514
 XWDCMP 471
 Y2DTONLY 471

SuperC process statements

+ (DPLINE operand) 483
 + (SRCHFOR operand) 488
 +start_column (DPLINE operand) 483
 +start_column (SRCHFOR operand) 488
 B (COLHEAD keyword) 481
 BTM (CMPBOFS keyword) 476
 BTM (CMPLINE keyword) 478
 BTM (CMPSECT keyword) 479
 C (COLHEAD keyword) 481
 D (COLHEAD keyword) 481
 end_col (CMPSECT operand) 480
 end_column (CMPCOLM operand) 477
 end_position (NEXCLUDE operand) 484
 end_position (NFOCUS operand) 485
 end_position (OEXCLUDE operand) 484
 end_position (OFOCUS operand) 485
 fixed (Y2PAST operand) 495
 hex_offset (CMPBOFS operand) 476
 last_start_column (CMPLINE operand) 478
 last_start_column (DPLINE operand) 483

SuperC process statements (*continued*)

last_start_column (LSTCOLM operand) 486
 last_start_column (NCHGT operand) 475
 last_start_column (OCHGT operand) 475
 last_start_column (SRCHFOR operand) 488
 line number (CMPLINE operand) 478
 NBTM 476
 NBTM (CMPBOFS keyword) 476
 NBTM (CMPLINE keyword) 478
 NBTM (CMPSECT keyword) 479
 new_member (SELECT operand) 489
 NTOP 476
 NTOP (CMPBOFS keyword) 476
 NTOP (CMPLINE keyword) 478
 NTOP (CMPSECT keyword) 479
 number (CHNGV operand) 474
 number (LNCT operand) 485
 number (LPSFV operand) 486
 OBTM 476
 OBTM (CMPBOFS keyword) 476
 OBTM (CMPLINE keyword) 478
 OBTM (CMPSECT keyword) 479
 OFF (SLIST operand) 490
 old_member (SELECT operand) 489
 ON (SLIST operand) 490
 OTOP 476
 OTOP (CMPBOFS keyword) 476
 OTOP (CMPLINE keyword) 478
 OTOP (CMPSECT keyword) 479
 output_string (NCHGT operand) 474
 output_string (OCHGT operand) 474
 P (COLHEAD keyword) 481
 P (SRCHFOR operand) 488
 RCVAL=number (REVREF operand) 487
 REFID=name (REVREF operand) 487
 S (SRCHFOR operand) 488
 search_member (SELECT operand) 489
 search_string (CMPLINE operand) 478
 search_string (CMPSECT operand) 480
 search_string (NCHGT operand) 474
 search_string (OCHGT operand) 474
 section ID (CMPSECT operand) 479
 sliding (Y2PAST operand) 495
 start_column (CMPCOLM operand) 477
 start_column (CMPLINE operand) 478
 start_column (CMPSECT operand) 480
 start_column (DPLINE operand) 483
 start_column (LSTCOLM operand) 486
 start_column (NCHGT operand) 474
 start_column (OCHGT operand) 474
 start_column (SRCHFOR operand) 488
 start_position (NEXCLUDE operand) 484

SuperC process statements (*continued*)

start_position (NFOCUS operand) 485
 start_position (OEXCLUDE operand) 484
 start_position (OFOCUS operand) 485
 string (SRCHFOR operand) 488
 title_name (NTITLE operand) 490
 title_name (OTITLE operand) 490
 TOP (CMPBOFS keyword) 476
 TOP (CMPLINE keyword) 478
 TOP (CMPSECT keyword) 479
 W (SRCHFOR operand) 488
 Z (COLHEAD keyword) 481

SuperC Process Statements panel 226
 SuperC program, requirements for 458
 SuperC programming interface 229
 SuperC reasons for differing comparison results 495

SuperC return codes

descriptions 496
 empty input file error 496
 error 496
 error return codes 496
 file attributes (inconsistent) 496
 inconsistent file attributes 496
 insufficient storage error 497
 invalid sequence numbers 496
 listing file error (disk full) 496
 listing file error (read only) 496
 listing file I/O error 496
 no common members/files to compare 496
 no data to compare error 496
 normal completion 496
 normal completion return codes 496
 storage (insufficient) error 497
 update file error (read only) 496
 update file I/O error 496
 warning 496
 warning return codes 496

SuperC search listing

page headings 517
 compare date 517
 compare time 517
 page number 517
 printer control character 517
 program date 517
 program ID 517
 program version 517

SuperC search process statements

* 475
 * 475
 CMPCOLM 477
 CMPLINE 478
 CMPSECT 479
 COLHEAD 481
 DPLINE 482
 DPLINEC 482
 LNCT 485
 LPSFV 486
 LSTCOLM 486
 NCHGT 474
 NTITLE 490
 SELECT 489
 SLIST 490

- SuperC search process statements
(*continued*)
 - SRCHFOR 487
 - SRCHFORC 487
- SuperC side-by-side listing 467
- SuperC update files
 - UPDCMS8 529, 530
 - UPDCNTL 530, 531, 532, 533
 - UPDLDEL 534
 - UPDMVS8 534, 535
 - UPDPDEL 535, 536
 - UPDREV 528
 - UPDREV2 Revision File (2) 529
 - UPDSEQ0 536
 - UPDSUMO 537, 538, 539
- SuperC Utility - Submit Batch Jobs panel
 - overview 214
 - using NOLIST 217
- SuperC utility (option 3.12)
 - applications 459
 - new data set 207
 - old data set 210
 - printing a Search-For listing in batch mode 236
 - printing a SuperC listing in batch mode 214
 - process options 461
 - program description 458
 - specifying members on a member list 213
 - submit options
 - 1 - generate output listing in DATA SET NAME 215
 - 2 - generate output listing using completed //OUTDD DD 216
 - blank - generate output listing to SYSOUT CLASS 215
 - utility differences 457
- SuperC Utility panel 208
- SuperC utility, requirements for 458
- SuperC workstation command 448
- SuperC, DBCS considerations 208
- SuperCE - Concatenation Batch Entry panel 224
- SuperCE - Concatenation Interactive Entry panel 223
- SuperCE - Profile Manager panel
 - option A - Activate 228
 - option C - Create 228
 - option D - Defaults 229
- SuperCE command 169
- SuperCE Profile Browse Display panel 227
- SuperCE utility (option 3.13)
 - applications 459
 - options
 - A - activate profiles and defaults 226
 - B - submit batch data set compare 223
 - Blank - compare data sets 222
 - E - edit SuperCE statements data set 225
 - P - select process options 461
 - P - select SuperCE process options 224
- SuperCE utility (option 3.13) (*continued*)
 - options (*continued*)
 - S - Extended Search-For utility 236
 - process options
 - overview 461
 - SuperC program description 458
 - SuperCE utility 217
 - utility differences 457
- SuperCE Utility panel 218
- symbolic debug data sets 345
- symbolic link information, z/OS
 - UNIX 298
- syntax diagrams, how to read xiv
- SYSLIB field
 - Batch Linkage Editor (option 5.7) 363
 - Foreground Linkage Editor (option 4.7) 335
- SYSLIN field
 - Batch Linkage Editor (option 5.7) 363
 - Foreground Linkage Editor (option 4.7) 335
- SYSOUT Class field
 - Batch Selection panel 355
 - Hardcopy Utility panel 185
 - SuperC - Submit Batch Jobs panel 214
- system command table 196
- system commands
 - DTEST 374
- SYSTEM DD statement, parameters
 - member 358
 - prefix 358

T

- T (truncation) column 198
- T (variable types) field
 - K (key) variable
 - add row 399
 - delete row 397
 - display row 395
 - N (name) variable
 - add row 399
 - delete row 397
 - display row 395
 - S (save) variable
 - add row 399
 - delete row 397
 - display row 395
- T record format, Allocate New Data Set panel 119
- table
 - date created/modified 258
 - editing/browsing
 - See ISPF Table Utility
 - export to data set 252, 265
 - find string in 255
 - import from data set 265
 - insert blank row 255
 - processing if already open 266
 - saving changes 249, 256
 - size (virtual storage required) 258
 - sorting rows 256
 - status 258
 - structure, displaying 259
 - table input library 196
- Table List panel 246, 247
- Table statistics, displaying 257
- Table structure, displaying 259
- Table Utility (option 3.16)
 - Browse command 247
 - CANCEL (table changes) command 252
 - Edit command 246, 247
 - EXPORT command 252
 - export report 262, 266
 - export to data set 265
 - extension variables 249
 - FEXPORT command 254
 - FILE command 254
 - find string in table 255
 - import from data set 265
 - INSERT command 255
 - options 261
 - output data set 260
 - overview 243
 - panel fields 244
 - performance 249
 - SAVE (table changes) command 256
 - saving changes 249
 - scrollable fields 249, 252
 - scrolling 249
 - select table from DD list 247
 - select table from library 245
 - sorting rows 256
 - STATS command 257
 - table structure, displaying 259
 - tables already open 266
- Table Utility Options panel 261
- Tables (option 7.4)
 - 1—display row 394
 - 2—delete row options 395
 - 3—modify row 396
 - 4—add row 398
 - 5—display structure 400
 - 6—display status 401
 - add row line command 400
 - CANCEL add row primary command 400
 - CANCEL modify row primary command 398
 - D (delete) add row line command 400
 - D (delete) modify row line command 398
 - END add row primary command 400
 - END display row command 395
 - END modify row primary command 398
 - I (insert) add row line command 400
 - I (insert) modify row line command 398
 - LOCATE add row primary command 400
 - LOCATE display row command 395
 - LOCATE display structure command 401
 - LOCATE modify row primary command 398
 - R (repeat) add row line command 400

Tables (option 7.4) (*continued*)
 R (repeat) modify row line
 command 398
 tape 117, 142
 TCP/IP address
 definition 62
 TERMIN command procedure
 statements 370
 terminal characteristics, specifying 27
 terminal data set, defined 358
 terminal type, specifying 27
 terminals
 Batch Assembler H (option 5.1) 358
 Batch Linkage Editor (option 5.7) 363
 Batch VS COBOL II compiler (option
 5.2) 359
 Batch VS FORTRAN compiler (option
 5.3) 360
 Test field
 Foreground VS COBOL II compiler
 (option 4.2) 331
 testing
 dialogs 373
 TSO 373
 usual test methods for dialog 373
 text strings, use of 88
 TIME parameter, SORT command 206
 tool integration program 68
 Total display view, Initial View field 145
 trace output in ISPF log
 function trace entries 406
 trace header entries 406
 variable trace entries 406
 Traces (option 7.7)
 1—function traces 410
 2—variable traces 412
 CANCEL Function Traces primary
 command 412
 CANCEL Variable Traces primary
 command 413
 D (delete) Function Traces line
 command 412
 D (delete) Variable Traces line
 command 413
 END Function Traces primary
 command 412
 END Variable Traces primary
 command 413
 I (insert) Function Traces line
 command 412
 I (insert) Variable Traces line
 command 413
 LOCATE Function Traces primary
 command 412
 LOCATE Variable Traces primary
 command 413
 R (repeat) Function Traces line
 command 412
 R (repeat) Variable Traces line
 command 413
 working with trace specifications 409
 Tracks field
 Data Set List utility 155
 VTOC Information Display 162
 TRACKS keyword, SORT command 178
 trademarks 547
 trigger statement errors 326

triggers
 expansion trigger, definition 323
 statement errors 326
 user-defined 324
 TRKS parameter, Space Units field 118
 Trks/Cyls field, VTOC Information
 Display 162
 TSO
 CLISTs and REXX EXECs
 Data Set List utility (option
 3.4) 156
 entering 369
 variables 158, 159
 commands
 ACCOUNT 117
 ALLOCATE 116
 DELETE 172
 TEST 373
 TSO ACCOUNT 97
 TSO command 440
 TSO command for member 113
 TSO workstation command 448
 TTR data 104
 Tutorial (option 7.T), displaying 420

U

U (uncatalog data set) line command,
 Data Set List utility (option 3.4) 168
 U (updating a format) line command,
 Format Specification utility (option
 3.11) 207
 U record format, Record Format
 field 119
 UA (user auditing) line command
 z/OS UNIX Directory List Utility
 (option 3.17) 306
 UIDs, switching 317
 uncatalog workstation command 448
 Underline headings (in export
 report) 263
 Unexclude Data Set command 169
 Unexclude First Data Set command 169
 Unexclude Last Data Set command 169
 Unicode
 FIND command 86
 viewing in Browse 80, 83
 Unit field, VTOC Information
 Display 161
 unmovable data set, defined 155
 UPD parameter, BROWSE Output
 field 222
 Update DS Name field, SuperC Utility -
 Old Data Set Name panel 210
 Update Dsn field, SuperCE Utility
 panel 221
 USASCII 88
 Use EDIT as default to process selected
 table option 261
 Use Edit to view the imported table 262
 user interface
 ISPF 541
 TSO/E 541
 user-defined trigger 324
 UTF8 88

Utilities (option 3)
 Command Table utility (option
 3.9) 196
 Data Set List utility (option 3.4) 140
 Data Set utility (option 3.2) 113
 Format Specification utility (option
 3.11) 201
 Hardcopy utility (option 3.6) 184
 ISPF C/S Install (option 3.7) 189
 Library utility (option 3.1) 101
 Move/Copy utility (option 3.3) 133
 Outlist utility (option 3.8) 193
 overview 2
 Reset ISPF Statistics utility (option
 3.5) 180
 Search-For utility (option 3.14) 230
 SuperC utility (option 3.12) 207
 SuperCE utility (option 3.13) 217
 Utility Selection Panel 101
 utility differences
 extended 457
 standard 457
 Utility Selection Panel 101

V

V (VDEFINE) variable, P (pool)
 field 389
 V (view data set) line command, Data Set
 List utility (option 3.4) 165
 V (view regular file) line command
 z/OS UNIX Directory List Utility
 (option 3.17) 307
 V record format, Record Format
 field 119
 VA (view ASCII file) line command
 z/OS UNIX Directory List Utility
 (option 3.17) 307
 VA command, Data Set List utility
 (option 3.4) 179
 Variables (option 7.3)
 CANCEL primary command 389
 creating new variables 390
 D (delete) line command 389
 DBCS data 391
 deleting variables 390
 END primary command 389
 hexadecimal data 391
 I (insert) line command 389
 input errors 390
 LOCATE primary command 389
 manipulating variables 390
 primary commands 389
 split-screen mode 391
 test mode 390
 usage notes 390, 391
 variable life 391
 variable value 391
 working with dialog variables 387
 variables, syntax diagrams xiv
 Verb column 198
 VERT parameter, HEX command 90
 View (option 1)
 description 77
 View Entry Panel 77
 view action prompt workstation
 command 448

VIEW command, Browse 93
 view output mode 209, 222, 232, 241
 View workstation command 448
 view, command table line command 201
 viewing a member 113
 Volume DATA field, VTOC Information
 Display 162
 Volume display view, Initial View
 field 145
 Volume field
 Data Set List utility 155
 Data Set List Utility panel 144
 VOLUME keyword, SORT
 command 178
 Volume Serial 97
 Volume Serial field
 Allocate New Data Set panel 117
 volume, DASD 97
 VS COBOL II compiler (option 4.2)
 overview 330
 VS COBOL II compiler (option 5.2) 359
 VS COBOL II interactive debug (option
 4.10) 343
 VS COBOL II interactive debug (option
 5.10) 364
 VS COBOL II Interactive Debug
 panel 364
 VS command, Data Set List utility (option
 3.4) 179
 VS data set organization, DSORG
 field 155
 VS FORTRAN compiler (option 4.3) 331
 VS FORTRAN compiler (option 5.3) 360
 VS Pascal compiler (option 4.6) 333
 VS Pascal compiler (option 5.6) 361
 VS-E 155
 VSAM (*VSAM*) entry in Volume
 field 143
 VSAM workstation command 448
 VT command, Data Set List utility
 (option 3.4) 179
 VTOC Data field, VTOC Information
 Display 162
 VTOC information display 161
 VTOC summary workstation
 command 447
 VU (view UTF8 file) line command
 z/OS UNIX Directory List Utility
 (option 3.17) 307
 VV command, Data Set List utility
 (option 3.4) 179

W

Warn if export data set exists 262
 Warn if table exists in the output
 library 262
 WE workstation command 448
 WEW workstation command 448
 wildcard characters 142
 Word parameter
 Compare Type field 219
 FIND command 86
 word, defined for SuperC 219
 Workplace (Option 11)
 action bar choices 428
 file 428

Workplace (Option 11) (continued)
 action bar choices (continued)
 options 436
 space 436
 SuperC 438
 test 438
 view 435
 actions that require prompt
 windows 439
 ISPF command shell 442
 move/copy 444
 rename 445
 reset statistics 440
 TSO command 440
 WS command 441
 commands 447
 entry panels 425
 data set view 426
 library view 426
 example scenario 453
 ISPF Library field 426
 ISPF referral lists 427
 Object Name field 427
 overview 425
 specifying actions 428
 Workplace example 453
 workplace function keys 448
 Workplace option description 2
 workplace settings 449
 workplace settings command 448
 WORKSIZE SuperC process
 statement 491
 Workstation agent 192
 installation program 192
 Workstation Commands
 = 448
 ACTBAR action prompt 447
 allocate 447
 allocate action prompt 447
 allocate SMS 448
 Browse 447
 catalog 447
 command action prompt 447
 compress 448
 Copy 447
 CUA attributes 447
 delete 447
 Delete 447
 delete action prompt 447
 DSLISL 447
 Edit 447
 edit action prompt 447
 full information action prompt 447
 global color change 447
 information action prompt 447
 ISPF command shell 447
 ISPF command table 447
 keylist 447
 list action prompt 447
 list view 447
 locate 447
 Member list 447
 Move 447
 NOACTBAR action prompt 447
 Open 447
 personal data set lists 447
 personal library lists 447

Workstation Commands (continued)
 point and shoot 448
 Print 447
 print action prompt 448
 print data set 447
 print data set index 448
 Print data set list 448
 Print VTOC information 448
 rename 447
 Rename 448
 rename action prompt 448
 reset action prompt 447
 SearchFor 448
 SearchFor extended 448
 select 448
 Settings 448
 short information 448
 Submit 447
 SuperC 448
 SuperC extended 448
 TSO 448
 uncatalog 448
 View 448
 view action prompt 448
 VSAM 448
 VTOC summary 447
 WE 448
 WEW 448
 WS 448
 WV 448
 WVW 448
 workstation connection 61
 workstation tool integration program
 action bar choices 69
 description 68
 editing 70
 extension mapping 71
 startup 68
 updating 70
 WPSET command 448
 WRITE parameter 403
 Writer name 185
 writing a list to a list data set
 data set list 174
 WS command 441
 WS command for member 113
 WS workstation command 448
 WV workstation command 448
 WVW workstation command 448

X

X (execute) line command
 z/OS UNIX Directory List Utility
 (option 3.17) 307
 X (print index listing) line command,
 Data Set List utility (option 3.4) 168
 XT field, Data Set list utility 155
 XT keyword, SORT command 178

Y

Y2PAST SuperC process statement 494
 YES parameter
 Active field 411, 413, 415
 BROWSE Output field 222

YES parameter (*continued*)
 Confirm Delete Request field,
 select 146
 Replace like-named members field,
 select 135
 Select pack option for "To" data set
 field 136
 Specify additional search strings field,
 select 232
 Table available field 402
 Table on disk field 403
 YYYY/MM/DD format, Expiration Date
 field 120
 YYYY.DDD format, Expiration Date
 field 120

Z

Z (compress data set) line command,
 Data Set List utility (option 3.4) 168
 z/OS system programmer
 applications 2
 z/OS UNIX
 execute command 307
 file permissions 282, 289, 302
 z/OS UNIX commands
 z/OS UNIX directory list 313
 z/OS UNIX Directory List Utility (option
 3.17)
 + (scroll indicator) 317
 AA (auditor auditing) line
 command 280
 action bar choices 273
 audit information 297
 B (browse) line command 281
 bypass z/OS UNIX File Edit Options
 panel 314
 C or CO (copy out) line
 command 281
 change column order and width 315
 CI (copy in) line command 286
 command time limit 314
 confirm file delete option 271, 314
 D (delete) line command 291
 device data information 297
 Display Directory List option 271
 display permissions in octal
 format 315
 E (edit) line command 291
 EA (edit) line command 291
 EDIT primary command 309
 EU (edit) line command 292
 extended attributes information 296
 FIND primary command 309
 FS (file system) line command 292
 I (information) line command 294
 L (List) line command 299
 LEFT primary command 310
 line command prefix characters 278
 line commands 279
 LOCATE primary command 310
 MA (modify ACL) line
 command 299
 MF (modify format) line
 command 300
 MG(modify group) line
 command 301

z/OS UNIX Directory List Utility (option
 3.17) (*continued*)
 MM (modify mode) line
 command 302
 MO (modify owner) line
 command 303
 mode fields information 296
 MX (modify extended attributes) line
 command 303
 N (new) line command 304
 options 313
 overview 269
 owner information 296, 299
 path name substitution character 314
 path names 317
 primary commands 308
 Print Directory List option 279
 R (rename) line command 305
 RA (add to personal data set list) line
 command 306
 REFRESH primary command 311
 RESET primary command 311
 restore default column
 arrangements 315
 RFIND primary command 309
 RIGHT primary command 311
 run command under login shell 278
 SAVE primary command 311
 scrollable fields for path names 317
 set and save default line
 commands 315
 SORT primary command 312
 sorting 273
 SU primary command 313, 318
 super-user mode 317
 switching UIDs 317
 symbolic link information 298
 time zone value 270
 timeout setting 314
 UA (user auditing) line
 command 306
 V (view regular file) line
 command 307
 VA (view ASCII file) line
 command 307
 view options 273
 VU (view UTF8 file) line
 command 307
 width of filename column 313
 X (execute) line command 307
 z/OS UNIX commands 313
 z/OS user applications 3
 ZDLBLSZ variable 158
 ZDLCAT variable 159
 ZDLCATNM variable 159
 ZDLCDATE variable 159
 ZDLCMD variable 159
 ZDLCONF variable 159
 ZDLDEV variable 159
 ZDLDSN variable 159
 ZDLDSNTP variable 159
 ZDLDSORG variable 159
 ZDLDST variable 160
 ZDLDSX variable 160
 ZDLEDATE variable 159
 ZDLEXT variable 159
 ZDLEXTX variable 159

ZDLLCMD variable 159
 ZDLLRECL variable 159
 ZDLMIGR variable 159
 ZDLMSG variable 160
 ZDLMVOL variable 159
 ZDLNDSN variable 160
 ZDLOVF variable 159
 ZDLRDATE variable 159
 ZDLRECFM variable 159
 ZDLREF variable 160
 ZDLSIZE variable 159
 ZDLSIZET variable 160
 ZDLSIZEX variable 159
 ZDLSIZTX variable 160
 ZDLSPACU variable 159
 ZDLUSED variable 159
 ZDLVOL variable 159
 ZPARM system variable
 parenthesis added to 199



Printed in USA

SC19-3628-00

